

Step, 60cm

FAZ30300

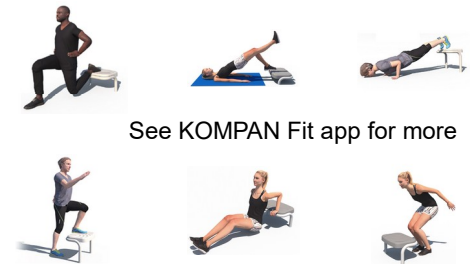

Item no. FAZ30300-0900	
General Product Information	
Dimensions LxWxH	61x41x58 cm
Age group	13+
Play capacity (users)	1
Color options	



See KOMPAN Fit app for more



The step is one of the most simple yet highly versatile training tools, so many exercises can be done with it, from simple step ups to plyometric jumps. Regular sessions will provide both cardiovascular and muscular endurance. Incorporating upper and lower body movements will improve balance and agility, and the constant push up onto the step will

increase leg strength.

Step, 60cm

FAZ30300



The support frame is $\varnothing 48.3 \times 4$ mm, carbon steel, with a hot-dip galvanised surface according to ISO1461, and a powder coating corrosion class C3 according to ISO12944-2. Lead content for surfaces are below 90ppm.



The surface is produced of recycled SBR (Styrene Butadiene Monomer, Synthetic Rubber) for optimal grip during jumping and step on step off exercises under all weather circumstances.



A 5 mm hot-dip galvanised carbon steel plate must be moulded inside the SBR to offer optimal stability and optimize the mounting of the step to the frame.

Item no. FAZ30300-0900

Installation Information

Max. fall height	58 cm
Safety surfacing area	10.4 m ²
Total installation time	1.7
Excavation volume	0.13 m ³
Concrete volume	0.07 m ³
Footing depth (standard)	90 cm
Shipment weight	52 kg
Anchoring options	In-ground ✓ Surface ✓



All KOMPAN fitness products are compliant with the ASTM F3101 & EN16630 Outdoor Fitness Standards. Load tests are performed as a static test by adding dynamic factors as well as safety factors to the specified load of 78kg per user. A product intended for 1 user is loaded with 420kg.



Sustainability Data

FAZ30300



Cradle to Gate A1-A3	Total CO ₂ emission	CO ₂ e/kg	Recycled materials
	kg CO ₂ e	kg CO ₂ e/kg	%
FAZ30300-0900	79.20	1.84	65.30

The overall framework applied for these factors is the Environmental Product Declaration (EPD), which quantifies "environmental information on the life cycle of a product and enable comparisons between products fulfilling the same function" (ISO, 2006). This follows the structure and applies a Life-Cycle Assessment approach to the entire Product stage from raw material through manufacturing (A1-A3))

Kompan A/S
 C.F. Tietgens Boulevard 32C
 DK-5220 Odense SØ
 Denmark



Verification of CO₂ calculation of: Fitness



Data version no. 2023-10-05

The CO₂ calculation and data are in compliance with the principles of a carbon footprint impact according to the GHG protocol (Greenhouse Gas Protocol), Scope 3, cradle to gate related to all individual components in the product category: "Fitness" represented by item no.: FAZ10100-0900.

(Scope 3 emissions include emission sources in the upstream and downstream value chain).

Date: 30. October 2023 | Valid until: 30. October 2025

Verified by:

Julie Marie Vejsgaard Larsen, LCA & EPD Consultant

Verification based on report: Validation of CO₂ calculation of 9 categories of Kompan product line, version 1.0, prepared by: Bureau Veritas HSE, Denmark: Julie M. V. Larsen.

Publication date: 30. October 2023

By Bureau Veritas HSE
 www.bureauveritas.dk
 +45 7731 1000



Step, 60cm

FAZ30300

* Max fall height | ** Total height | *** Safety surfacing area

* Max fall height | ** Total height

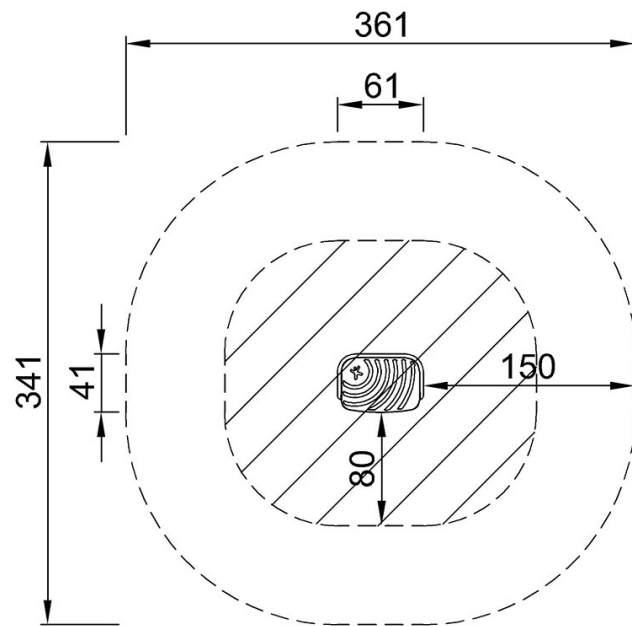

FAZ30300
*58cm
**58cm
***10.4m²

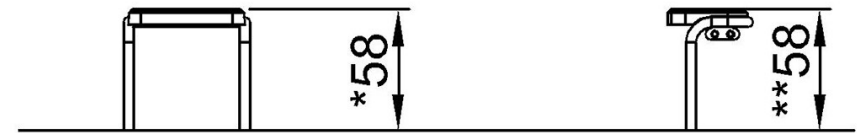

FAZ30300

[Click to see TOP VIEW](#)

[Click to see SIDE VIEW](#)