

Leg Press Pro

FAZ603

KOMPAN
Let's play



| | |
|------------------------------------|---|
| Item no. FAZ60300-0001 | |
| General Product Information | |
| Dimensions LxWxH | 5'4"x7'9"x7'0" |
| Age group | 13+ |
| Play capacity (users) | 1 |
| Color options |  |



See KOMPAN Fit App for More Information



With adjustable load, adjustable seat, and large footplate, the machine facilitates individually adapted exercises that strengthen hip extensor, knee extensor and ankle muscles in a horizontal forward movement. The strength machines and benches allow for simple, safe, and effective strength training for all major muscle groups. This increases daily functional

capacity, especially for the elderly, sports performance, aesthetic appearance, and metabolic fitness. The 130kg weight stack is fully covered and can be adjusted in steps of 10kg by a smart and patented handle. Making the product very easy to train on and completely safe to be in the outdoors!

Leg Press Pro

FAZ603

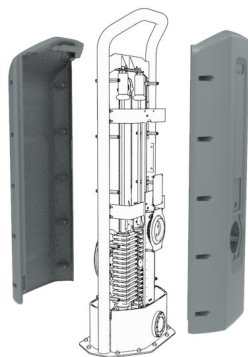

The cover protects all the moving parts from vandalism and entrapments. The cover is made of 5mm rotomolded LLDPE, Linear low-density polyethylene, with excellent impact strength and usable within a large temperature span.

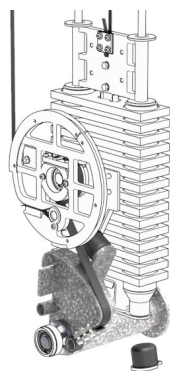

The resistance unit and all mechanical stops are hidden in the fully closed cabinet. As a result, entrapment is not possible, making it extremely safe to use and providing protection against the elements. The products are EN 16630 certified and comply with the ASTM F3101 for unsupervised outdoor fitness equipment.

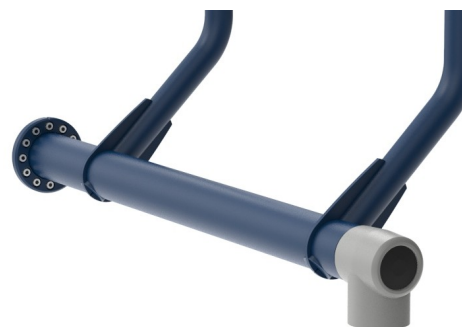

The input shaft is Ø101,3 x 2,9mm S355 Hot Dip Galvanized and Powder-coated steel. The bearing house is Cast Aluminum (EN AB-44100 / EN AB-AISI12(a)) with self-aligning sealed ball bearings. An extremely strong and durable construction.

| Item no. FAZ60300-0001 | |
|--------------------------|--------------------|
| Installation Information | |
| Max. fall height | 2'1" |
| Safety surfacing area | 155ft ² |
| Total installation time | 10.0 |
| Excavation volume | 0yd ³ |
| Concrete volume | 0yd ³ |
| Footing depth (standard) | 0'0" |
| Shipment weight | 1578lbs |
| Anchoring options | Surface ✓ |
| Warranty Information | |
| Hot dip galvanized steel | Lifetime |
| Movable parts | 2 Years |
| PUR components | 10 Years |
| ROSTA element | 2 Years |
| Spare Parts Availability | 10 Years |



The footplate is made from Stainless Steel this provides good protection against corrosion. The plate also has an Anti Slip texture for optimal grip.



The seat and head support are made of Polyurethane Rubber and have a steel insert plate that connects it to the steel frame. The seat is adjustable in 14 different settings to fit users from 140/ 205 cm tall and to vary the type of exercises. The seat is positioned under a 12-degree angle and the back supports a 48-degree angle. The back support has a groove, accommodating a comfortable position.

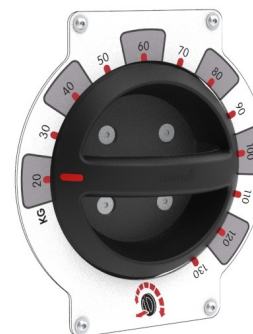

The 130kg weight stack is fully covered and can be adjusted with a rotatable handle in 12 steps of 10 kg. The smart selector system is intuitive in use and patent-pending. No pins that get lost or get stuck, you simply pull and rotate the handle to select a different weight.

**ASTM
F3101**
compliant

Sustainability Data

FAZ603



| Cradle to Gate A1-A3 | Total CO ₂ emission | CO ₂ e/kg | Recycled materials |
|----------------------|--------------------------------|-------------------------|--------------------|
| | kg CO ₂ e | kg CO ₂ e/kg | % |
| FAZ60300-0001 | 1,713.43 | 2.97 | 44.80 |

The overall framework applied for these factors is the Environmental Product Declaration (EPD), which quantifies "environmental information on the life cycle of a product and enable comparisons between products fulfilling the same function" (ISO, 2006). This follows the structure and applies a Life-Cycle Assessment approach to the entire Product stage from raw material through manufacturing (A1-A3))

Kompan A/S
C.F. Tietgens Boulevard 32C
DK-5220 Odense SØ
Denmark



Verification of CO₂ calculation of: Fitness



Data version no. 2023-10-05

The CO₂ calculation and data are in compliance with the principles of a carbon footprint impact according to the GHG protocol (Greenhouse Gas Protocol), Scope 3, cradle to gate related to all individual components in the product category: "Fitness" represented by item no.: FAZ10100-0900.

(Scope 3 emissions include emission sources in the upstream and downstream value chain).

Date: 30. October 2023 | Valid until: 30. October 2025

Verified by:

Julie Marie Vejsgaard Larsen, LCA & EPD Consultant

Verification based on report: Validation of CO₂ calculation of 9 categories of Kompan product line, version 1.0, prepared by: Bureau Veritas HSE, Denmark: Julie M. V. Larsen.

Publication date: 30. October 2023

By Bureau Veritas HSE
www.bureauveritas.dk
+45 7731 1000



Leg Press Pro

FAZ603

* Max fall height | ** Total height | *** Safety surfacing area

* Max fall height | ** Total height

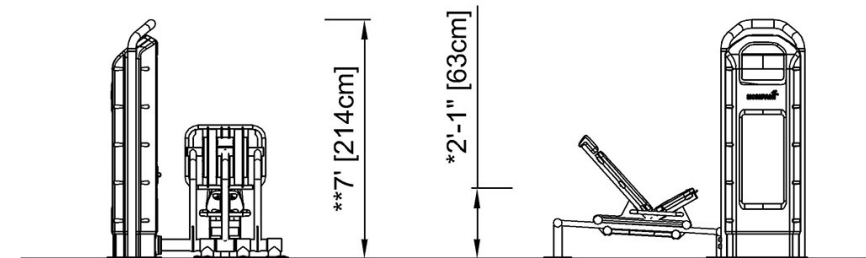
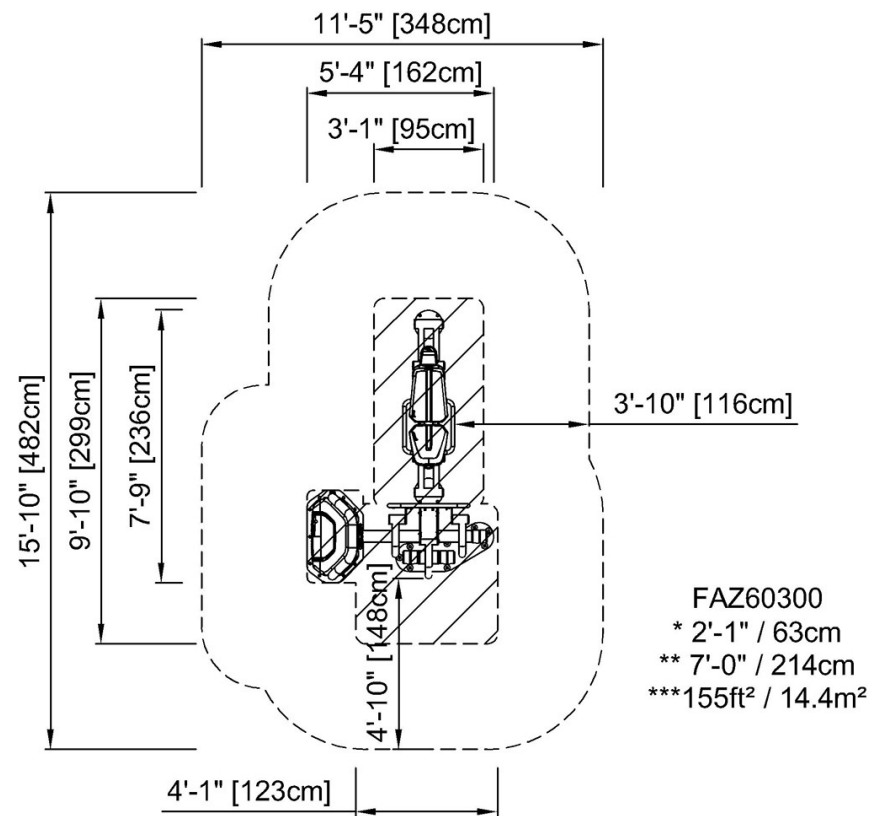

FAZ603

[Click to see TOP VIEW](#)

[Click to see SIDE VIEW](#)