

Flex Wheel & Leg Lift

FSW237



Item no. FSW23700-0902

General Product Information

Dimensions LxWxH 79x93x167 cm

Age group 13+

Play capacity (users) 2

Colour options



See KOMPAN Fit app for more



The Flex Wheel is simple to use and requires little experience beforehand. The turning movement has a mild resistance suitable for users at all levels. The ergonomically designed handles allow for natural wrist position and gives the user the opportunity to do exercises from multiple positions. The wheel will train shoulder and upper body mobility. For really

challenging exercises it can be used standing on one foot using one hand – either front facing or sideways.

The Leg Lift Station is an excellent piece of equipment for ab workouts. It allows users to exercise their abdominal muscles by performing leg lifts while holding themselves up in the chair. Exercising in this manner targets

all of the abdominal muscles.



Data is subject to change without prior notice.

Flex Wheel & Leg Lift

FSW237



Steps are made of extruded aluminium with a non-skid surface. Aluminium has high corrosion resistance and ensures durability of the product. Steps have been mounted at heights of 34,7cm and 54,7cm this creates an easy access to reach the overhead activity



The frame of the leg lift is made from Ø38 x 2mm HDG steel tube. The support plates are made from 15mm Ekogrip®, a 15 mm PE plate with a 3 mm top-layer of thermoplastic rubber with non-skid effect. The arm supports are 110 x 195mm, 580mm apart, and 1315mm above ground. The back support is 335 x 500mm. The opening in the back is 30 x 350mm.



The information sign is made of a PA6 (Polyamide) and shows the most relevant exercise and a QR code. When scanned the QR code will link to an animated illustration of the exercise and offers the possibility of downloading the KOMPAN sport & fitness App, which will provide a large amount of exercises and workouts.

Item no. FSW23700-0902

Installation Information

Max. fall height	132 cm
Safety surfacing area	12.6 m ²
Total installation time	4.3
Excavation volume	0.23 m ³
Concrete volume	0.12 m ³
Footing depth (standard)	90 cm
Shipment weight	87 kg
Anchoring options	In-ground ✓ Surface ✓

Warranty Information

Connector brackets	10 years
EcoCore HDPE	Lifetime
Hot dip galvanised steel	Lifetime
Post	10 years
Spare parts guaranteed	10 years



The ball grips are ø80mm and are made from black, vacuum formed polycarbonate (PC). Polycarbonate is extremely strong and can withstand a very high impact.



The bearing house is made from hot dip galvanised steel. The bearing shaft is made from stainless steel AISI304. The bearing itself is made from Polyoxymethylene (POM), an engineering thermoplastic with a high stiffness, low friction, and excellent dimensional stability.



The ø800x19mm wheel is made from HDPE EcoCore™ plate. EcoCore™ is a highly durable, ecofriendly material, which is not only recyclable after use, but is also made of +95% recycled post-consumer material from e.g., food packing waste in both core and colorful outer layer.



Sustainability Data

FSW237



Cradle to Gate A1-A3	Total CO ₂ emission	CO ₂ e/kg	Recycled materials
	kg CO ₂ e	kg CO ₂ e/kg	%
FSW23700-0902	154.61	2.69	52.97

The overall framework applied for these factors is the Environmental Product Declaration (EPD), which quantifies "environmental information on the life cycle of a product and enable comparisons between products fulfilling the same function" (ISO, 2006). This follows the structure and applies a Life-Cycle Assessment approach to the entire Product stage from raw material through manufacturing (A1-A3))

Kompan A/S
C.F. Tietgens Boulevard 32C
DK-5220 Odense SØ
Denmark



Verification of CO₂ calculation of: Fitness



Data version no. 2023-10-05

The CO₂ calculation and data are in compliance with the principles of a carbon footprint impact according to the GHG protocol (Greenhouse Gas Protocol), Scope 3, cradle to gate related to all individual components in the product category: "Fitness" represented by item no.: FAZ10100-0900.

(Scope 3 emissions include emission sources in the upstream and downstream value chain).

Date: 30. October 2023 | Valid until: 30. October 2025

Verified by:

Julie Marie Vejsgaard Larsen, LCA & EPD Consultant

Verification based on report: Validation of CO₂ calculation of 9 categories of Kompan product line, version 1.0, prepared by: Bureau Veritas HSE, Denmark: Julie M. V. Larsen.

Publication date: 30. October 2023

By Bureau Veritas HSE
www.bureauveritas.dk
+45 7731 1000



Flex Wheel & Leg Lift

FSW237

* Max fall height | ** Total height | *** Safety surfacing area

* Max fall height | ** Total height

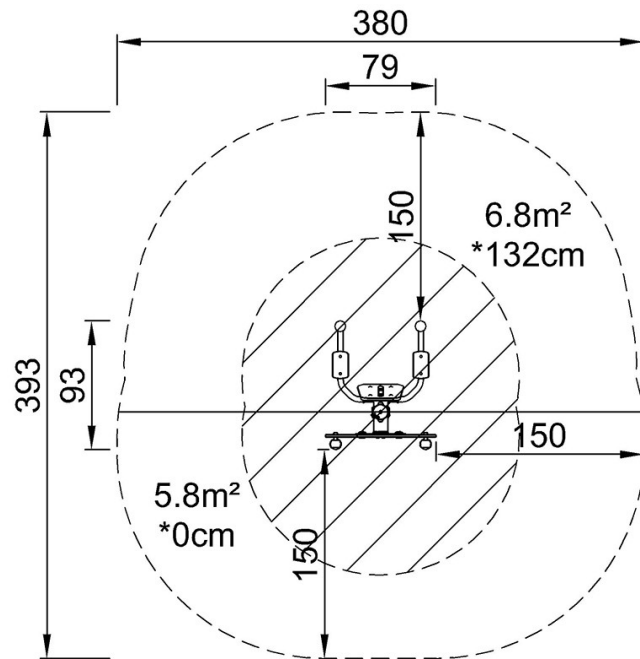

FSW23700
*132cm
**167cm
***12.6m²

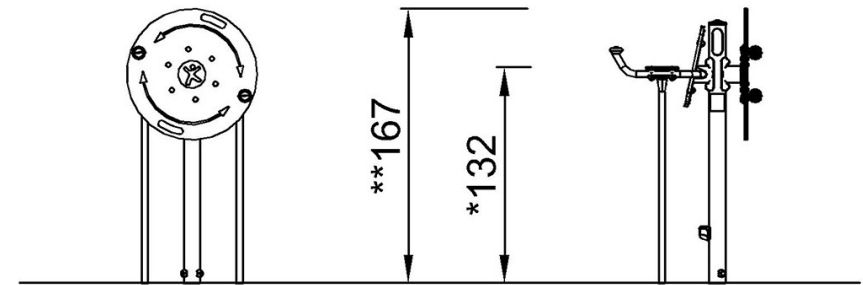

FSW23700

[Click to see TOP VIEW](#)

[Click to see SIDE VIEW](#)