

Crumb Net

COR24301

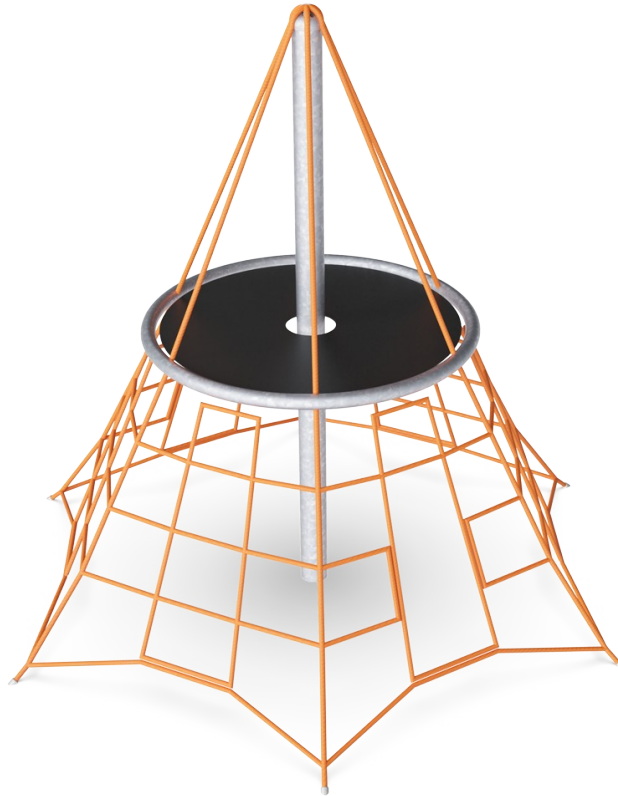

The Crumb Net is a bouncy climber for the younger users, with a clear, solid destination and meeting point on the top of the piece. The big mesh allows for children climbing through to play under the deck and socialise. Major muscle groups are used when children climb in the Crumb Net: arms push and pull, legs push and the core provides stability. All these

physical skills and the act of climbing up are fundamental to motor skills such as cross-body coordination and spatial awareness. This positively impacts children's ability to judge distances and navigate traffic confidently.

Item no. COR243011-0804	
General Product Information	
Dimensions LxWxH	283x246x240 cm
Age group	3+
Play capacity (users)	12
Color options	

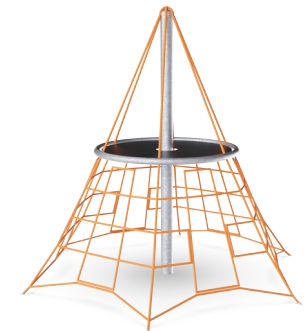
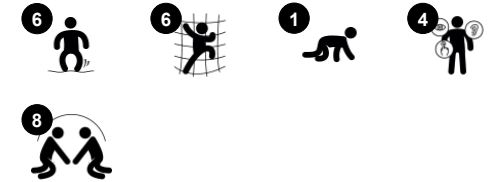

Crumb Net

COR24301



Platform

Social-Emotional: Important life skills like courage, self-confidence, consideration and turn-taking are built.

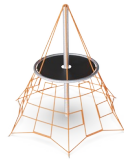
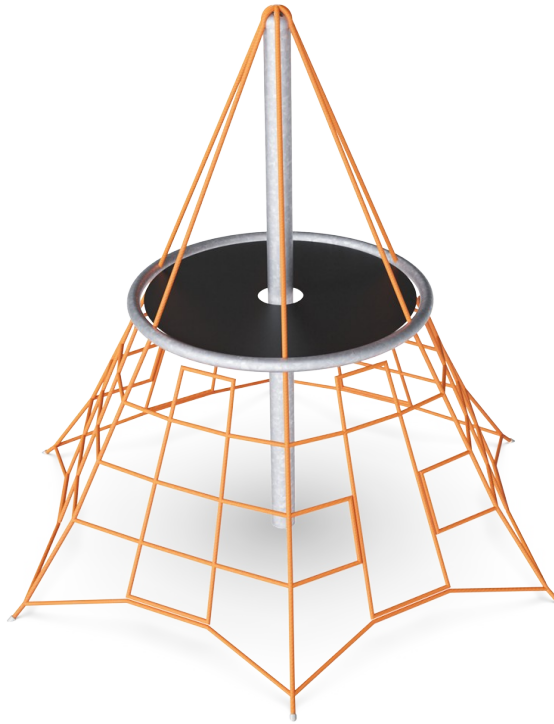

Big meshes

Physical: the big meshes allow for climbing and crawling, supporting proprioception, cross coordination and spatial awareness. Climbing here takes muscle strength, pushing and pulling arms to get upwards. **Social-Emotional:** allow more children being seated together, sharing.

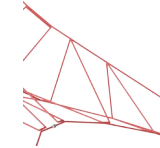

Bouncy net meshes

Physical: agility, balance and coordination as well as spatial awareness are supported when bouncing, climbing and sitting in the net. Children use muscle strength of arms, legs and core, and build bone density when jumping down. **Social-Emotional:** the bouncing, swaying net appeals to empathy and cooperation. **Cognitive:** physical memory, logical thinking, concentration.

Crumb Net

COR24301



Ropes of UV-stabilized PES rope strands with inner steel cable reinforcement. The polyester yarn is made from +95% post-consumer materials and is inductively melted onto each strand. The ropes are highly wear- and vandalism-resistant and can be replaced at site if needed.



Corocord 'S' clamps are used as universal connections in Corocord products. 8mm stainless steel rods with rounded edges are pressed around the ropes with a special hydraulic press, making them the ideal connector: safe, durable and vandalism-proof, all while allowing the typical movement of rope play structures.



The spacenets' main bearing ropes are equipped with an additional safety feature: should the main connections fail, the safety rope prevents collapse of the structure.

Item no. COR243011-0804

Installation Information

Max. fall height	120 cm
Safety surfacing area	26.4 m ²
Total installation time	7.7
Excavation volume	2.25 m ³
Concrete volume	1.19 m ³
Footing depth (standard)	85 cm
Shipment weight	206 kg
Anchoring options	In-ground ✓



Corocord membranes consist of friction-proof rubberized material of conveyor belt quality with excellent UV resistance. Tested and compliant with REACH requirements for PAH. Embedded is a four-layered armoring made of woven polyester. The armoring and the two surface layers result in a total thickness of 7.5 mm.



In the centre of the net is the mast, made of high quality seamless steel. The structure of the mast as an oscillating support is statically favourable and equalizes the oscillations in the net. The masts are hot dip galvanised as standard, with the design option of additional powder coating.



Through KOMPAN Variant Team, you can choose between additional 7 rope colours and customize your solution. The assortment is a wide span of colours ranking from elegant and expressive black or natural and toned-down hemp colour, to a range of attractive and eye-catching signal colours.



Sustainability Data

COR24301

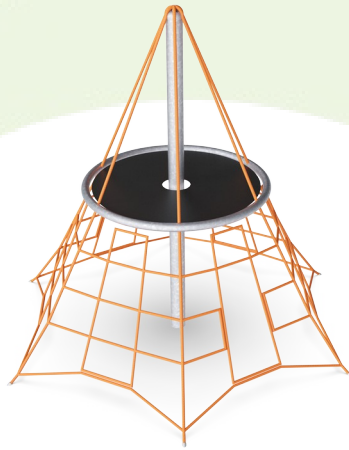

Cradle to Gate A1-A3	Total CO ₂ emission	CO ₂ e/kg	Recycled materials
	kg CO ₂ e	kg CO ₂ e/kg	%
COR243011-0804	509.14	3.20	48.65

The overall framework applied for these factors is the Environmental Product Declaration (EPD), which quantifies "environmental information on the life cycle of a product and enable comparisons between products fulfilling the same function" (ISO, 2006). This follows the structure and applies a Life-Cycle Assessment approach to the entire Product stage from raw material through manufacturing (A1-A3))

Kompan A/S
 C.F. Tietgens Boulevard 32C
 DK-5220 Odense SØ
 Denmark



Verification of CO₂ calculation of: Corocord



Data version no. 2023-10-05

The CO₂ calculation and data are in compliance with the principles of a carbon footprint impact according to the GHG protocol (Greenhouse Gas Protocol), Scope 3, cradle to gate related to all individual components in the product category: "Corocord" represented by item no.: COR314011-1101.

(Scope 3 emissions include emission sources in the upstream and downstream value chain).

Date: 30. October 2023 | Valid until: 30. October 2025

Verified by:

Julie Marie Vejsgaard Larsen, LCA & EPD Consultant

Verification based on report: Validation of CO₂ calculation of 9 categories of Kompan product line, version 1.0, prepared by: Bureau Veritas HSE, Denmark: Julie M. V. Larsen.

Publication date: 30. October 2023

By Bureau Veritas HSE
 www.bureauveritas.dk
 +45 7731 1000



Crumb Net

COR24301

* Max fall height | ** Total height | *** Safety surfacing area

* Max fall height | ** Total height

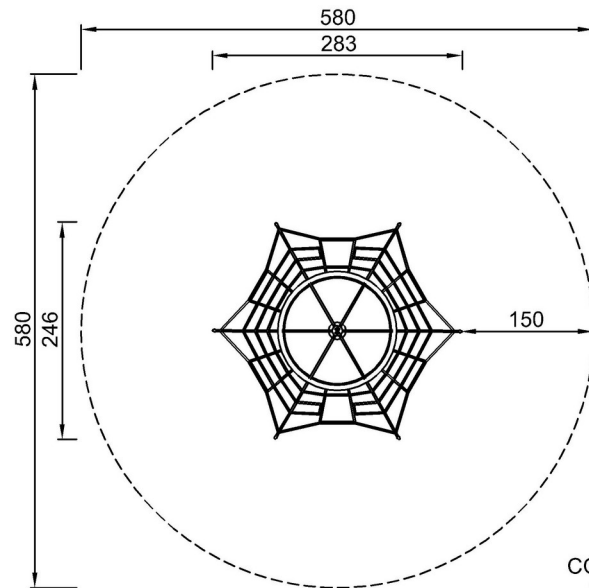

COR243011
*120cm
**240cm
***26.4m²

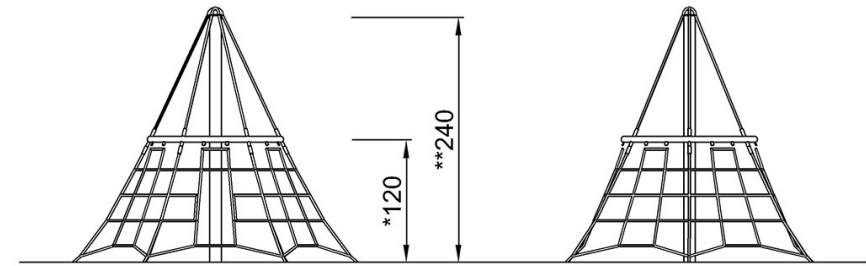

COR243011

[Click to see TOP VIEW](#)

[Click to see SIDE VIEW](#)