

Cableway, flat ground, slide length 25m

M87202

Item no. M87202-3817

General Product Information

Dimensions LxWxH	3358x358x394 cm
Age group	5 - 12
Play capacity (users)	1
Colour options	●

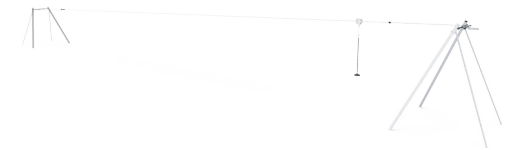
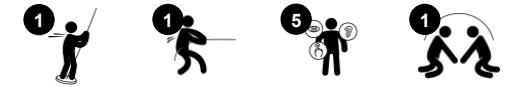

WOW! The Zipline is a playground magnet. Children whizz through the air and run the seat back to start to begin a new flight, over and over again. The Zipline ticks boxes in age-appropriately challenging play: the speed when whizzing through the air truly tickles the stomach and makes children want to try out the Zipline repeatedly. Apart from being great fun,

the ride also trains important motor skills such as spatial awareness and the sense of balance. These motor skills are fundamental in mastering body movements and navigating the world securely. Running the seat back to start is great cardio training for children. Social-emotionally, the thrill element of the Zipline widens children's comfort zones of actions they

can make. This hugely boosts self confidence.

Cableway, flat ground, slide length 25m

M87202



Dino seat

Physical: the three divisions and chains of the seat provide efficient handholds for both standing and seated swinging. **Social-Emotional:** the possibility of children swinging together, legs hanging down, trains cooperation, sequencing and turn-taking when swinging.

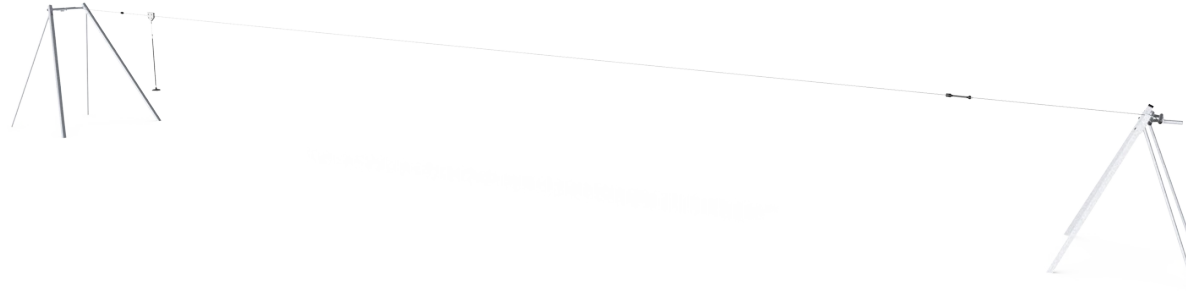

Long line

Physical: the lengthy glide through the air adds to the thrill and trains spatial awareness, trunk stability and upper-body muscles. All this helps support the child's physical self esteem, making e.g. positive risk taking easier.



PUR covered rope

Physical: firm grip when spinning and hanging from arms. Arm muscles developed when holding tight.

Cableway, flat ground, slide length 25m

M87202



The steel surfaces are hot dip galvanised inside and outside with lead free zinc. The galvanisation has excellent corrosion resistance in outside environments and requires low maintenance.



The special designed seat is made of a steel insert covered with a soft layer of silicon rubber. The seat is impact tested to fulfill all global playground standards and the rope has an ergonomic handhold.



The high-quality steel cable with a diameter of 12mm is designed for heavy usage of the cableway for many years. The starting point is indicated by a knob. At the stop point there is special designed spring device ensuring a softer stop of the puller.

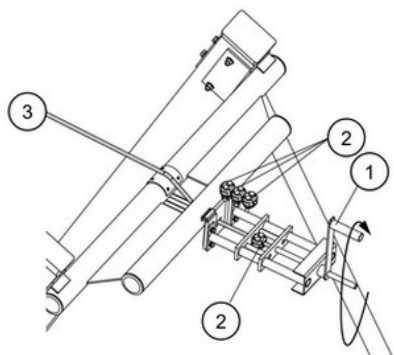

The steel cable 3 is tensioned by a special designed device. By turning the handle 1 the steel cable can be tensioned according to instruction in a safe way. After tensioning the cable is locked by three clamps 2. The tensioning device can also be used for adjustment during annual inspections.

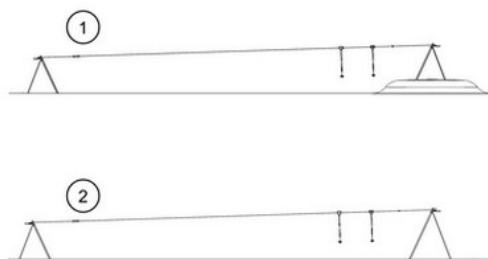

KOMPAN cableways are available for flat or natural sloped surroundings and for surface or in-ground installation. Further the cableways can be supplied with one or two cables for children to ride together in friendly competition. For flat surroundings a starting mound or platform is needed to use the cableway.

Item no. M87202-3817	
Installation Information	
Max. fall height	100 cm
Safety surfacing area	138.0 m ²
Total installation time	8.3
Excavation volume	3.81 m ³
Concrete volume	1.15 m ³
Footing depth (standard)	100 cm
Shipment weight	397 kg
Anchoring options	In-ground ✓ Surface ✓
Warranty Information	
Cable	10 years
Hot dip galvanised steel	Lifetime
Movable parts	2 years
Rubber seat	2 years
Spare parts guaranteed	10 years

Elevated activities 0	Accessible elevated activities	Accessible ground level activities	Accessible ground level play types
Present	0	1	1
Required	0	1	1

CSA
Z614
compliant

Sustainability Data

M87202



Cradle to Gate A1-A3	Total CO ₂ emission	CO ₂ e/kg	Recycled materials
	kg CO ₂ e	kg CO ₂ e/kg	%
M87202-3817	1,018.73	2.58	49.77

The overall framework applied for these factors is the Environmental Product Declaration (EPD), which quantifies "environmental information on the life cycle of a product and enable comparisons between products fulfilling the same function" (ISO, 2006). This follows the structure and applies a Life-Cycle Assessment approach to the entire Product stage from raw material through manufacturing (A1-A3))

Kompan A/S
 C.F. Tietgens Boulevard 32C
 DK-5220 Odense SØ
 Denmark



Verification of CO₂ calculation of: Freestanding play equipment



Data version no. 2023-10-05

The CO₂ calculation and data are in compliance with the principles of a carbon footprint impact according to the GHG protocol (Greenhouse Gas Protocol), Scope 3, cradle to gate related to all individual components in the product category: "Freestanding play equipment" represented by item no.: KSW92011-0910.

(Scope 3 emissions include emission sources in the upstream and downstream value chain).

Date: 30. October 2023 | Valid until: 30. October 2025

Verified by:

Julie Marie Vejsgaard Larsen, LCA & EPD Consultant

Verification based on report: Validation of CO₂ calculation of 9 categories of Kompan product line, version 1.0, prepared by: Bureau Veritas HSE, Denmark: Julie M. V. Larsen.

Publication date: 30. October 2023

By Bureau Veritas HSE
 www.bureauveritas.dk
 +45 7731 1000



Cableway, flat ground, slide length 25m

M87202

* Max fall height | ** Total height | *** Safety surfacing area

* Max fall height | ** Total height

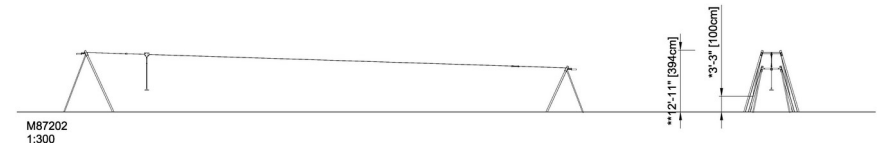
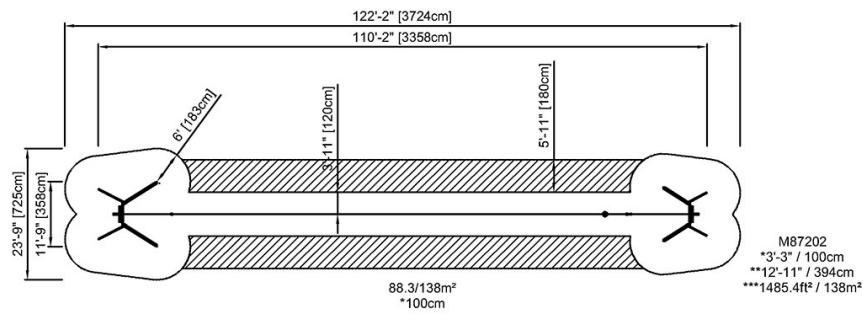

[Click to see TOP VIEW](#)

[Click to see SIDE VIEW](#)