

Adventurer

PCE400121

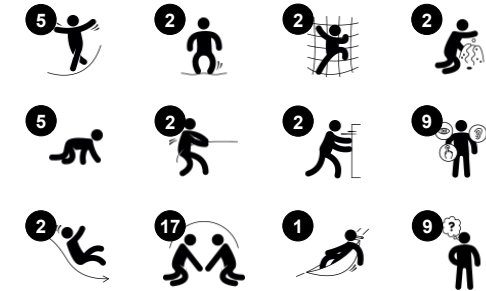

Item no. PCE400121-0602	
General Product Information	
Dimensions LxWxH	712x697x340 cm
Age group	1+
Play capacity (users)	55
Colour options	● ● ●



The Adventurer with its whimsical look and vast variety of play activities is hugely attractive to infants and toddlers. They will return again and again, thanks to the adventurous nature of the many play events. Bouncy and sturdy climbs, crawling in the tunnels and the responsive membrane bridge all develop cross-coordination and balance skills. The bridge

builds bone density when children jump. Many play panels and lovely quiet corners for a break from intense play, add explorative elements for dexterity and logical thinking skills. The many ground level sensory play features offer something for everyone to play. The swaying hammock offers a break, too. The thrilling slides are the reward for climbing up, and a

loop of play is created, for everyone to run up and slide down.



Data is subject to change without prior notice.

Adventurer

PCE400121



Talk tube

Social-Emotional: encourages communication and social interaction.
Cognitive: evokes curiosity and stimulates an understanding of cause and effect and object permanence: objects and persons exist also when out of sight.



Conveyor panel

Physical: tactile stimulation from running hands over rolling spheres on conveyor belt.
Social-Emotional: spurs group play and conversations with its two-sidedness.
Cognitive: understanding of object permanence when pictures roll away and reappear.



Tunnel

Physical: the children crawl through the tunnel, developing motor skills such as cross-body coordination and proprioception. **Social-Emotional:** turn-taking when passing each other.



Membrane bridge

Physical: agility, balance and coordination, force of movement and sense of effort. Development of bone density when jumping.
Social-Emotional: turn-taking, problem solving and cooperation when bouncing others. Relaxation when lying or sitting, being bounced by others. **Cognitive:** understanding of cause and effect, logical thinking.



Hammock

Physical: coordination and sense of balance when swaying. **Social-Emotional:** meeting, pushing friends gently back and forth, turn-taking.



Sand scoops panel

Physical: hand eye coordination and push-pull movements. **Social-Emotional:** invites cooperation due to the two-sidedness and provides for parallel play. **Cognitive:** logical thinking: cause and effect understanding when running scoops in grooves or shifting materials from scoop to scoop. **Creative:** shifting scoops, creating new scoop positions.



Crawl-through hole

Physical: the hole allows for climbing and crawling through, developing cross coordination, proprioception and spatial awareness. **Social-Emotional:** cooperation and turn-taking when passing one another. **Cognitive:** understanding space, shape and measures when seeing if the body can fit through the hole.

Adventurer

PCE400121

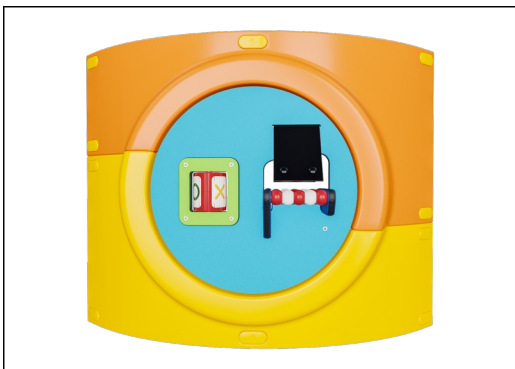

The Curved ELEMENTS panels are moulded of UV stabilised recyclable PE using 33% post-consumer recycled material. With multiple options for in-build play features that also ensures a strong panel solution. Straight panels are made of KOMPAN 19mm HDPE EcoCore™ which is a highly durable, ecofriendly and recyclable material made from +95% PCM.

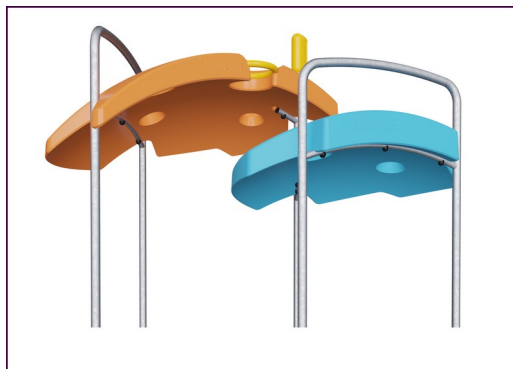

The ELEMENTS roofs are made of recyclable PE made from 33% post consumer recycled materials with a minimum wall thickness of 5 mm to ensure high durability in all climates around the world. The steel pipes are hot dip galvanised inside and outside for maximum durability.



ELEMENTS products are available in three different colour combinations: classic blue & green, blossom orange & yellow, nature lime and green.

Item no. PCE400121-0602

Installation Information

Max. fall height	100 cm
Safety surfacing area	74.2 m ²
Total installation time	49.6
Excavation volume	1.33 m ³
Concrete volume	0.14 m ³
Footing depth (standard)	80 cm
Shipment weight	1,530 kg
Anchoring options	Surface ✓ In-ground ✓

Warranty Information

Curved panels	10 years
EcoCore HDPE	Lifetime
Membrane	2 years
Post	10 years
Spare parts guaranteed	10 years



The main posts are made of high quality pregalvanized steel with powder coated top finish. Post tops are closed with caps of UV stabilized nylon (PA6). The grey colored molded decks are made of 75% post-consumer waste PP material with a non-skid pattern and texture surface. All decks are supported by unique designed low-carbon aluminum profiles with multiple attachment options.

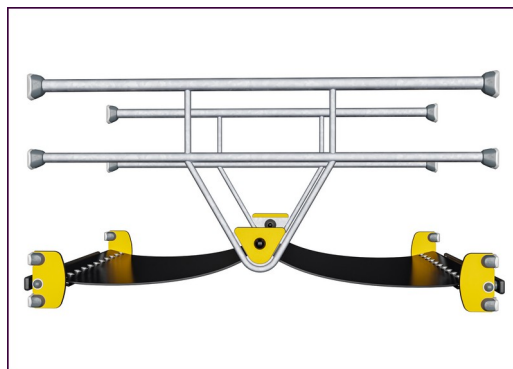

ELEMENTS rubber membranes are conveyor belt made of layers of rubber mixed of natural rubber and SBR rubber, and embedded with layers of armouring made of woven PE and PA. The thickness 8mm ensures high durability in any environment.

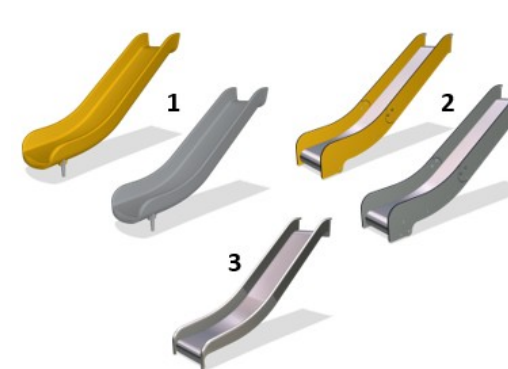

The slides are available in either molded PE made from 33% recycled post-consumer materials in different colors or in full AISI304 stainless steel with a thickness of 2mm.



Sustainability Data

PCE400121



Cradle to Gate A1-A3	Total CO ₂ emission	CO ₂ e/kg	Recycled materials
	kg CO ₂ e	kg CO ₂ e/kg	%
PCE400121-0602	2,836.11	2.42	50.12

The overall framework applied for these factors is the Environmental Product Declaration (EPD), which quantifies "environmental information on the life cycle of a product and enable comparisons between products fulfilling the same function" (ISO, 2006). This follows the structure and applies a Life-Cycle Assessment approach to the entire Product stage from raw material through manufacturing (A1-A3))

Kompan A/S
 C.F. Tietgens Boulevard 32C
 DK-5220 Odense SØ
 Denmark



Verification of CO₂ calculation of: Play systems



Data version no. 2023-10-05

The CO₂ calculation and data are in compliance with the principles of a carbon footprint impact according to the GHG protocol (Greenhouse Gas Protocol), Scope 3, cradle to gate related to all individual components in the product category: "Play systems" represented by item no.: PCM200321-0950.

(Scope 3 emissions include emission sources in the upstream and downstream value chain).

Date: 30. October 2023 | Valid until: 30. October 2025

Verified by:

Julie Marie Vejsgaard Larsen, LCA & EPD Consultant

Verification based on report: Validation of CO₂ calculation of 9 categories of Kompan product line, version 1.0, prepared by: Bureau Veritas HSE, Denmark: Julie M. V. Larsen.

Publication date: 30. October 2023

By Bureau Veritas HSE
 www.bureauveritas.dk
 +45 7731 1000



Adventurer

PCE400121

* Max fall height | ** Total height | *** Safety surfacing area

* Max fall height | ** Total height

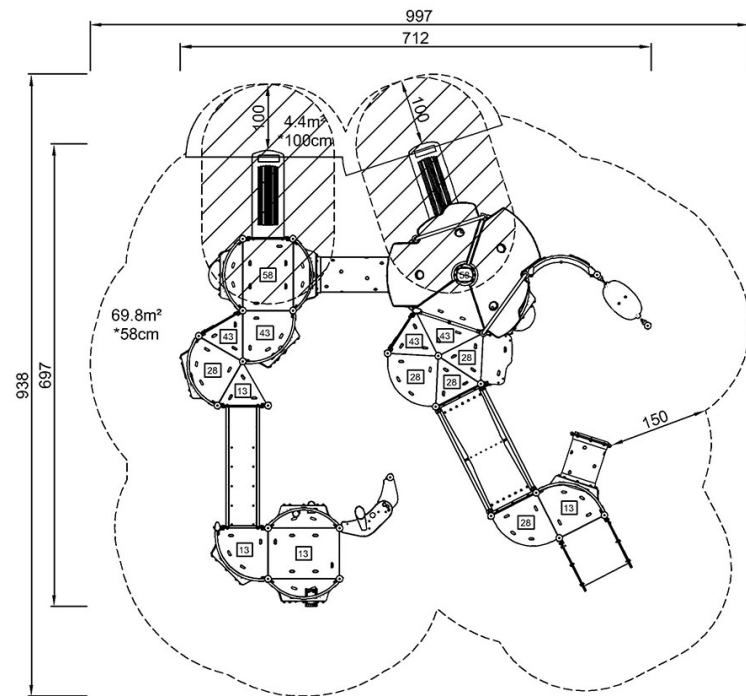

PCE400121
*100cm
**340cm
***74.2m²

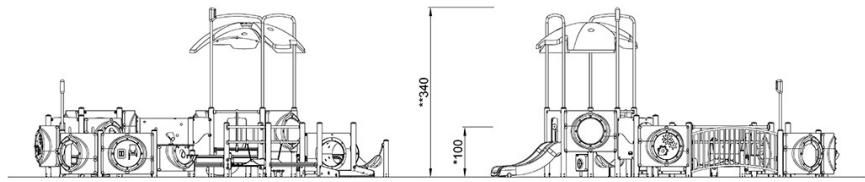

PCE400121

[Click to see TOP VIEW](#)

[Click to see SIDE VIEW](#)