



# Double Cableway, sloping ground, slide length 25m

NRO880



Item no. NRO880-1001	
<b>General Product Information</b>	
Dimensions LxWxH	3321x512x298 cm
Age group	4+
Play capacity (users)	2
Colour options	 



Children absolutely love playing on the Double Cableway! Anyone can play on the cableway due to its length and supportive seat and handhold. The thrill of gliding through the air makes children want to play on the cableway again and again. The feeling of weightlessness and the swooshing through the air, helps develop spatial awareness skills as well as the

child's understanding of gravity, space and speed. Social skills are trained as children diligently hand back the seat to the next user in line. The running and pulling involved in this trains the child's cardio as well as upper body muscles. All in all, the large cableway is an asset of play that unites generations and abilities as there is some way for almost

everyone to use it.

# Double Cableway, sloping ground, slide length 25m

NRO880



## PUR covered rope

**Physical:** firm grip when spinning and hanging from arms. Arm muscles developed when holding tight.



## Long line

**Physical:** the lengthy glide through the air adds to the thrill and trains spatial awareness, trunk stability and upper-body muscles. All this helps support the child's physical self esteem, making e.g. positive risk taking easier.



## Dino seat

**Physical:** the three divisions and chains of the seat provide efficient handholds for both standing and seated swinging. **Social-Emotional:** the possibility of children swinging together, legs hanging down, trains cooperation, sequencing and turn-taking when swinging.



## Double zipline

**Social-Emotional:** the possibility to glide with a companion or have friendly competitions supports turn taking and cooperation skills. **Cognitive:** the speed may differ between the two Ziplines. Figuring out the reason behind this (weight, speed, force etc.) trains logical thinking.

# Double Cableway, sloping ground, slide length 25m

NRO880



All Organic Robinia products by KOMPAN are made of Robinia wood from sustainable European sources. On request it can be supplied as FSC® Certified (FSC® C004450).



The steel surfaces are hot dip galvanised inside and outside with lead free zinc. The galvanisation has excellent corrosion resistance in outside environments and requires low maintenance.



The special designed seat is made of a stainless-steel insert covered with a soft layer of PUR rubber. The seat is impact tested to fulfill all global playground standards and the rope has an ergonomic handhold of a 100cm long moulded on PUR rubber handle.

Item no. NRO880-1001

### Installation Information

Max. fall height	100 cm
Safety surfacing area	182.1 m <sup>2</sup>
Total installation time	14.1
Excavation volume	9.37 m <sup>3</sup>
Concrete volume	3.84 m <sup>3</sup>
Footing depth (standard)	100 cm
Shipment weight	897 kg
Anchoring options	In-ground ✓

### Warranty Information

Cable	10 years
Movable parts	2 years
PUR components	10 years
Robinia wood	15 years
Spare parts guaranteed	10 years



The high-quality steel cable with a diameter of 12mm is designed for heavy usage of the cableway for many years. The starting point is indicated by a knob. At the stop point there is special designed spring device ensuring a softer stop of the puller.

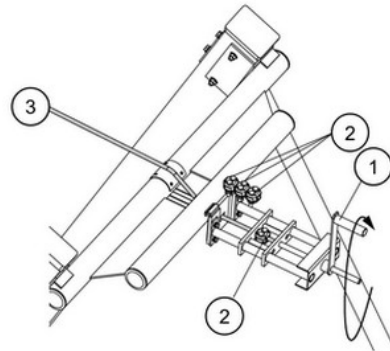

The steel cable 3 is tensioned by a special designed device. By turning the handle 1 the steel cable can be tensioned according to instruction in a safe way. After tensioning the cable is locked by three clamps 2. The tensioning device can also be used for adjustment during annual inspections.

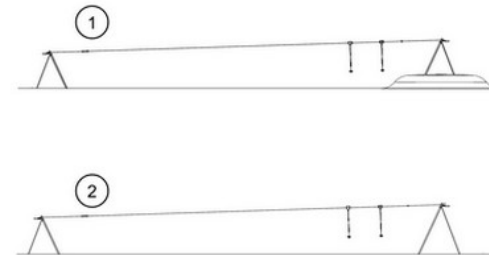

KOMPAN cableways are available for flat or natural sloped surroundings and for surface or in-ground installation. Further the cableways can be supplied with one or two cables for children to ride together in friendly competition. For flat surroundings a starting mound or platform is needed to use the cableway.



# Sustainability Data

NRO880

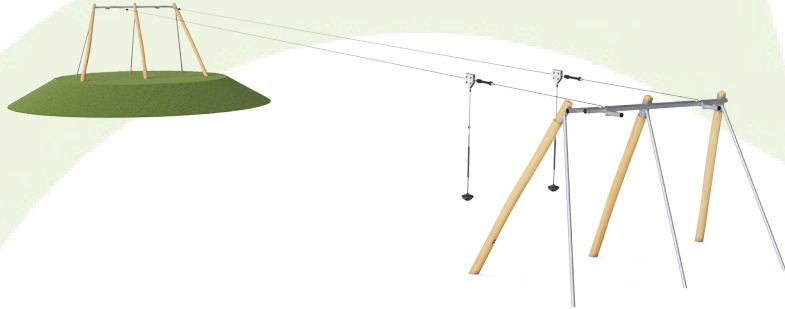

Cradle to Gate A1-A3	Total CO <sub>2</sub> emission	CO <sub>2</sub> e/kg	Recycled materials
	kg CO <sub>2</sub> e	kg CO <sub>2</sub> e/kg	%
<b>NRO880-1001</b>	1,092.60	1.39	25.28

The overall framework applied for these factors is the Environmental Product Declaration (EPD), which quantifies "environmental information on the life cycle of a product and enable comparisons between products fulfilling the same function" (ISO, 2006). This follows the structure and applies a Life-Cycle Assessment approach to the entire Product stage from raw material through manufacturing (A1-A3))

**Kompan A/S**  
 C.F. Tietgens Boulevard 32C  
 DK-5220 Odense SØ  
 Denmark



## Verification of CO<sub>2</sub> calculation of: Nature play



Data version no. 2023-10-05

The CO<sub>2</sub> calculation and data are in compliance with the principles of a carbon footprint impact according to the GHG protocol (Greenhouse Gas Protocol), Scope 3, cradle to gate related to all individual components in the product category: "Nature play" represented by item no.: NRO409-0621.

(Scope 3 emissions include emission sources in the upstream and downstream value chain).

**Date: 30. October 2023 | Valid until: 30. October 2025**

**Verified by:**

Julie Marie Vejsgaard Larsen, LCA & EPD Consultant

Verification based on report: Validation of CO<sub>2</sub> calculation of 9 categories of Kompan product line, version 1.0, prepared by: Bureau Veritas HSE, Denmark: Julie M. V. Larsen.

**Publication date: 30. October 2023**

**By Bureau Veritas HSE**  
 www.bureauveritas.dk  
 +45 7731 1000



# Double Cableway, sloping ground, slide length 25m

NRO880

\* Max fall height | \*\* Total height | \*\*\* Safety surfacing area

\* Max fall height | \*\* Total height

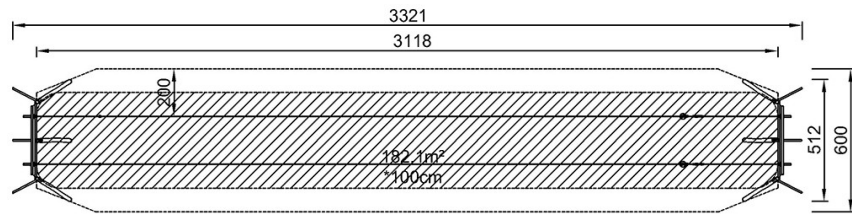

NRO880  
\*100cm  
\*\*298cm  
\*\*\*182.1m<sup>2</sup>

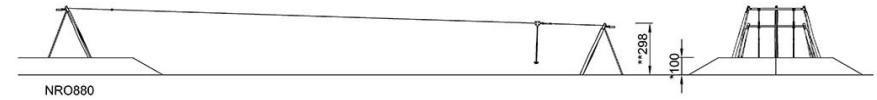

[Click to see TOP VIEW](#)

[Click to see SIDE VIEW](#)