

Jumper Square, 100x100cm

JUM101

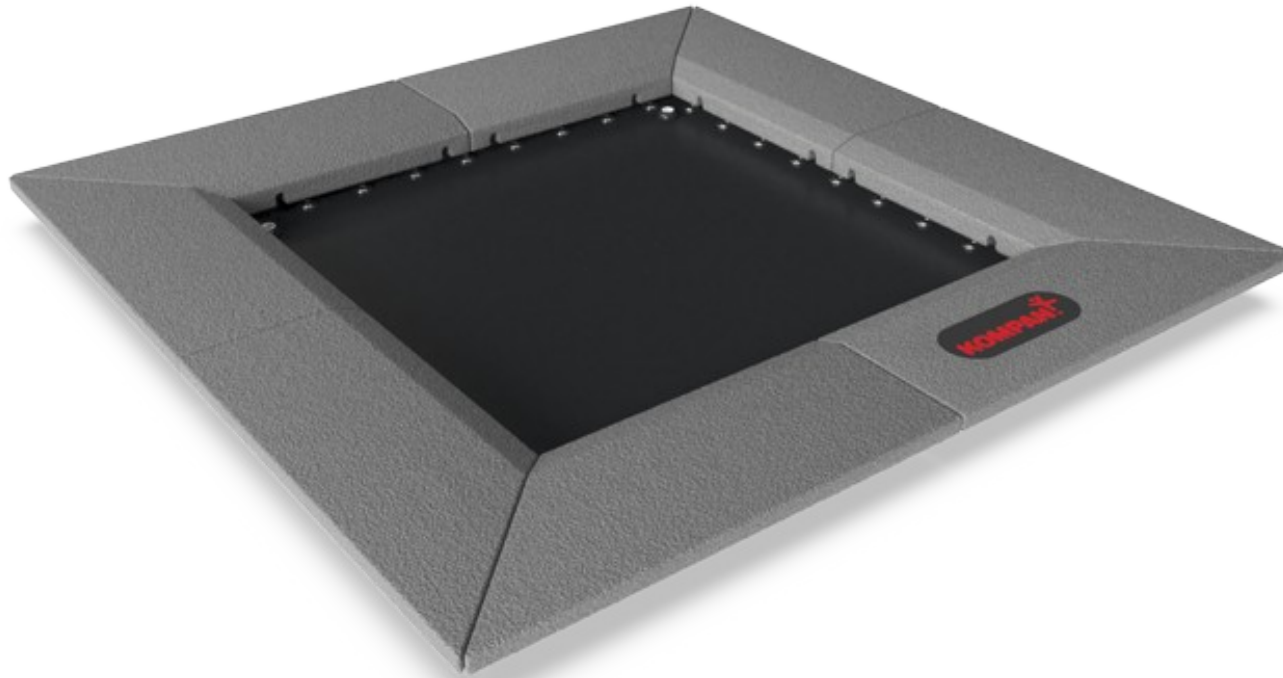

Item no. JUM10101-0301	
General Product Information	
Dimensions LxWxH	160x160x3 cm
Age group	4+
Play capacity (users)	1
Colour options	●

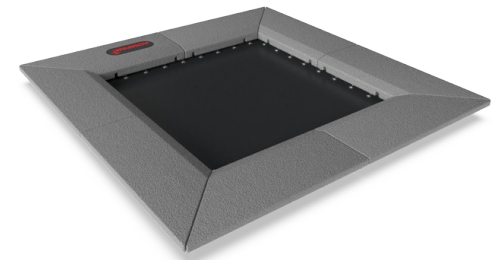
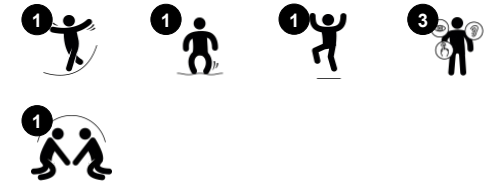

Bouncing on the Jumper Square is one of the most popular activities of the playground. The children will be highly attracted to the immediate response of the Jumper to their movements and jump repeatedly. The small measure of the Jumper makes it perfect as playground "glue", connecting activities when put together in paths. This will support games

like The Ground is Lava. Jumping is a fantastic activity for motor skills such as balance, proprioception and rhythm. When jumping up and down, all big muscle groups get trained. The jumping on and off the Jumper additionally builds bone density. Bone density is primarily built during early youth, so to build strong bones for life, children should take as much

weight bearing activity as they can. There are few ways funnier than the responsive Jumper.

Jumper Square, 100x100cm

JUM101

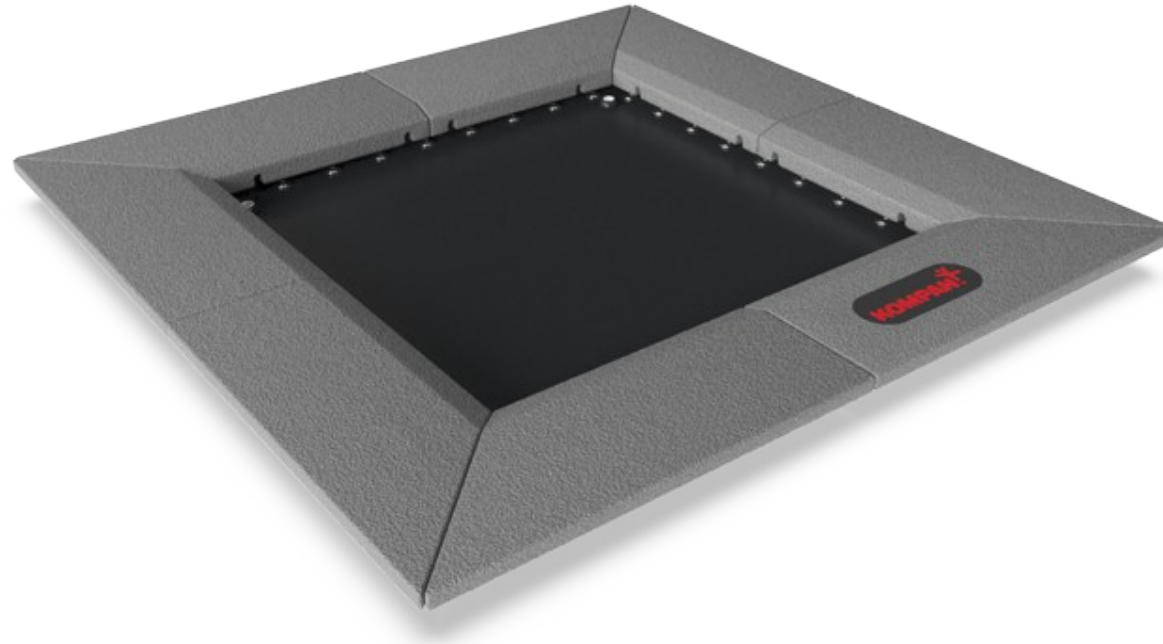

Sturdy rubber edging

Social-Emotional: supports turn-taking skills and cooperation offering a sturdy, yet softer waiting and observing space for children about to enter.

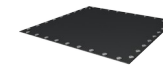

Bouncy floor

Physical: trains motor skills ABC: agility, balance and coordination, as well as proprioception and rhythm when jumping on and off. Bone density is built when jumping on and off. **Social-Emotional:** turn-taking and cooperation skills when timing when to jump in and out, one after the other.

Jumper Square, 100x100cm

JUM101

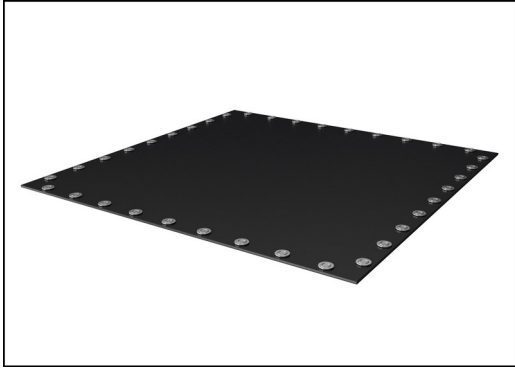

The jumping membranes are made of 6,0mm thick EP Ethylene-Propylene conveyor belt with polyester polyamide fabric carcass. Spring fixations are reinforced with steel bushings and washers on both sides. The membrane is ozone resistant and equipped with 8 center placed water drain holes.



All 36 springs are made of stainless steel to ensure durability and excellent corrosion resistance. The steel wire is 3,2 mm thick and the last five windings are cone shaped to ensure long lifetime of the jumper.

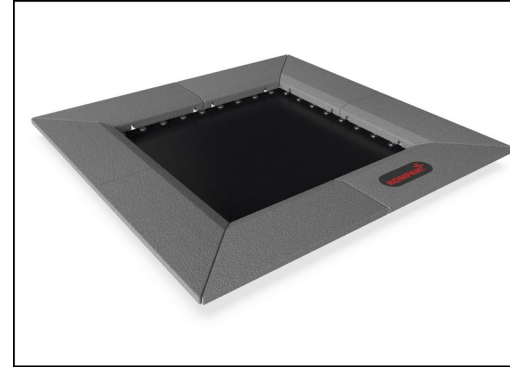

The tiles are molded in grey granulated recycled rubber (SBR/NR), and the KOMPAN logo is made of EPDM Ethylene Propylene Diene Monomer. Inside each of the rubber tiles there is a 3 mm hot dip galvanized steel plate.

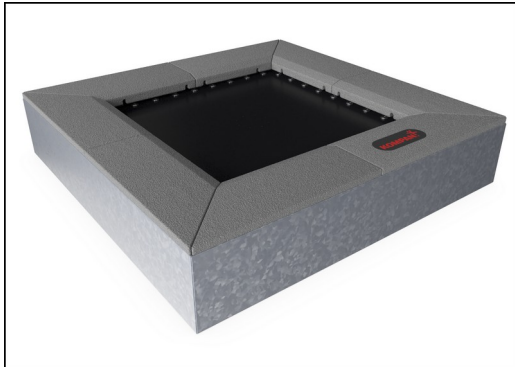

All steel components are manufactured from carbon steel S235 in a thickness of 3 mm. Side panels, support walls for top frame, plates bended with SBR and plates flat for in-situ surfacing are hot dip galvanized.

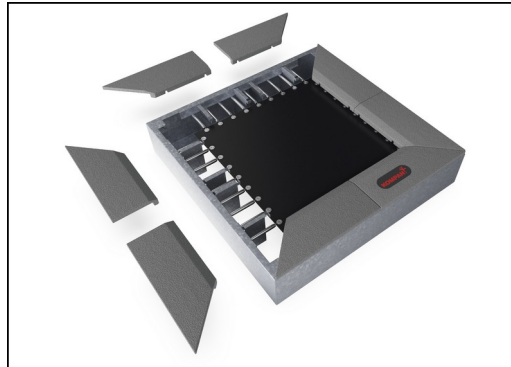

As a unique feature the SBR tiles can be removed for cleaning and service. By loosen six screws the SBR tile can be lifted up to open and gain access to the springs (see instruction on KOMPAN Master).

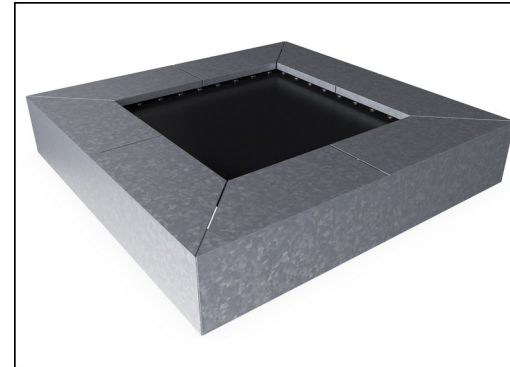

If customized colors of the surfacing is requested all jumpers can be ordered with steel plates suitable for in situ surfacing in preferred color. For in situ installations there is no service opening option.

Item no. JUM10101-0301

Installation Information

Max. fall height	100 cm
Safety surfacing area	14.1 m ²
Total installation time	3.0
Excavation volume	1.09 m ³
Concrete volume	0.08 m ³
Footing depth (standard)	60 cm
Shipment weight	313 kg
Anchoring options	In-ground ✓

Warranty Information

Hot dip galvanised steel	Lifetime
Jumper springs	2 years
Jumping bed material	2 years
SBR rubber	2 years
Spare parts guaranteed	10 years



Sustainability Data

JUM101

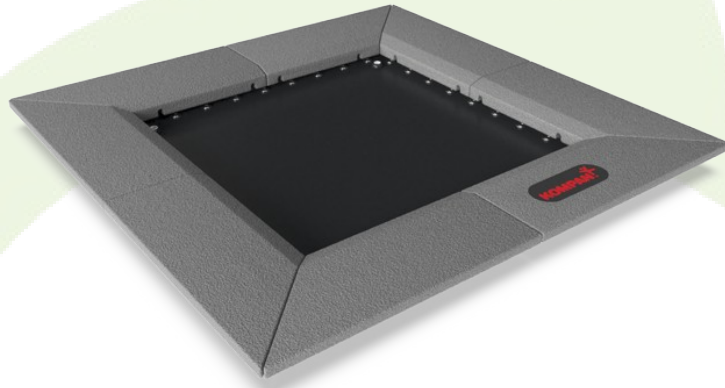

Cradle to Gate A1-A3	Total CO ₂ emission	CO ₂ e/kg	Recycled materials
	kg CO ₂ e	kg CO ₂ e/kg	%
JUM10101-0301	410.22	2.04	60.36

The overall framework applied for these factors is the Environmental Product Declaration (EPD), which quantifies "environmental information on the life cycle of a product and enable comparisons between products fulfilling the same function" (ISO, 2006). This follows the structure and applies a Life-Cycle Assessment approach to the entire Product stage from raw material through manufacturing (A1-A3))

Kompan A/S
 C.F. Tietgens Boulevard 32C
 DK-5220 Odense SØ
 Denmark



Verification of CO₂ calculation of: Freestanding play equipment



Data version no. 2023-10-05

The CO₂ calculation and data are in compliance with the principles of a carbon footprint impact according to the GHG protocol (Greenhouse Gas Protocol), Scope 3, cradle to gate related to all individual components in the product category: "Freestanding play equipment" represented by item no.: GXY916012-3417.

(Scope 3 emissions include emission sources in the upstream and downstream value chain).

Date: 30. October 2023 | Valid until: 30. October 2025

Verified by:

Julie Marie Vejsgaard Larsen, LCA & EPD Consultant

Verification based on report: Validation of CO₂ calculation of 9 categories of Kompan product line, version 1.0, prepared by: Bureau Veritas HSE, Denmark: Julie M. V. Larsen.

Publication date: 30. October 2023

By Bureau Veritas HSE
 www.bureauveritas.dk
 +45 7731 1000



Jumper Square, 100x100cm

JUM101

* Max fall height | ** Total height | *** Safety surfacing area

* Max fall height | ** Total height

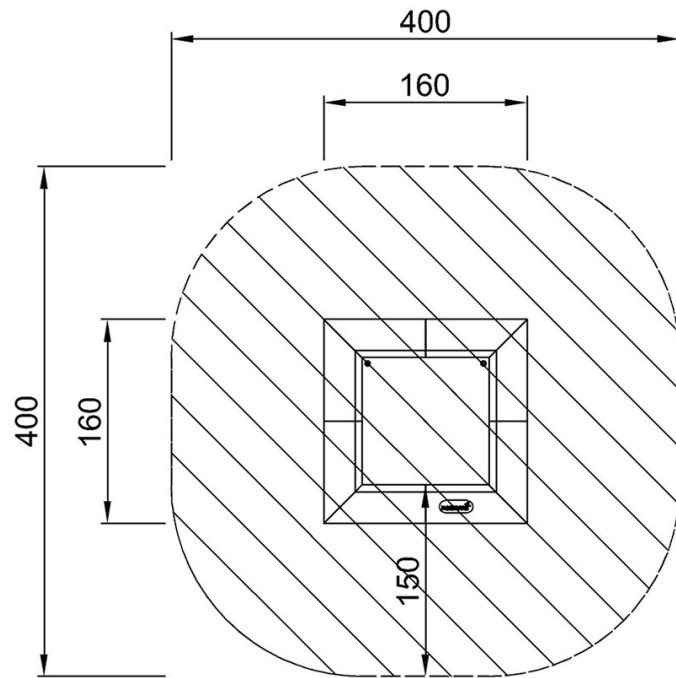

JUM10101
*100cm
**3cm
***14.1m²

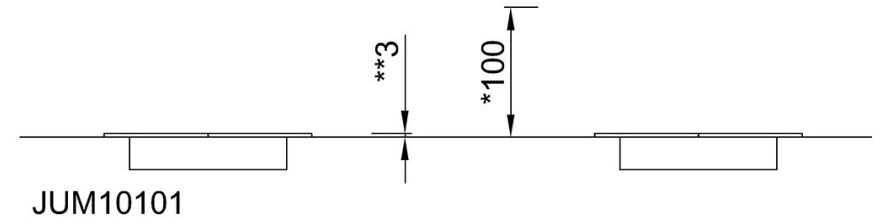

[Click to see TOP VIEW](#)

[Click to see SIDE VIEW](#)