

Play Panel 1 - Creative

PCM000621

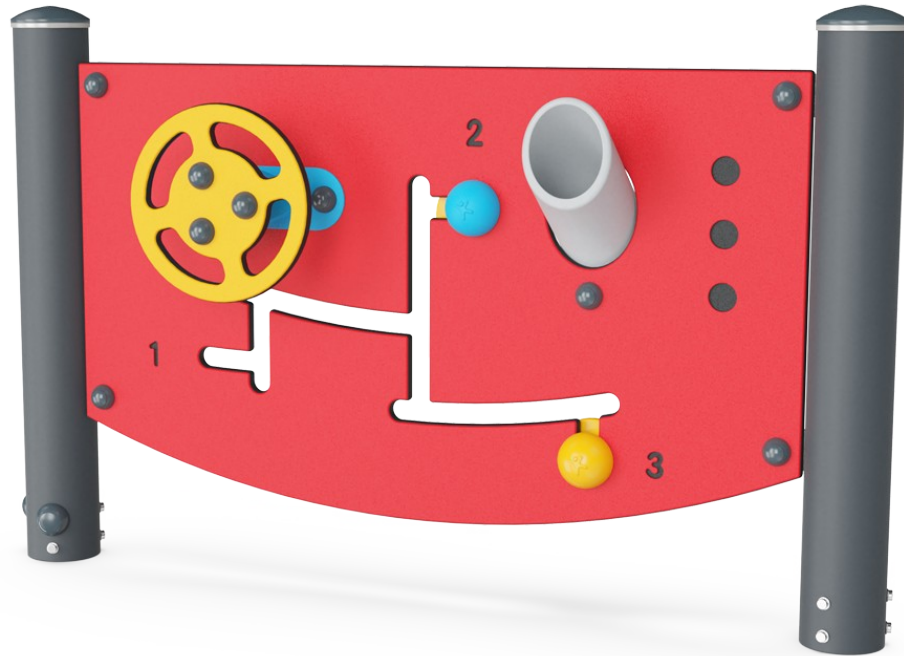

Item no. PCM000621-0901	
General Product Information	
Dimensions LxWxH	121x28x75 cm
Age group	1+
Play capacity (users)	4
Colour options	

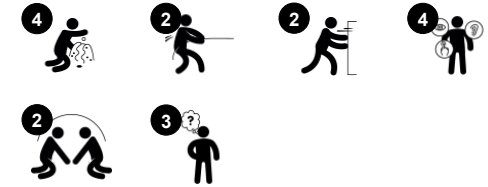

Wow! The children can't keep their hands off the Manipulative Play Panel. The variation of responsive play elements inspires exploration. The wide panel and the fact that all items on one side are connected to action on the other side support cause and effect understanding as well as cooperation and turn-taking in social play. The feedback to the child's actions is

important to logical thinking: The steering wheel moves another wheel. The play spheres with numbers move play shovels on the other side. The funnel turns up on one side, and down on the other. This invites infants and children to run items or sand through, a favourite pastime which stimulates object permanence understanding that items and

persons don't cease to exist when out of sight. The shovels can be placed to catch and transport sand in creative play.



Play Panel 1 - Creative

PCM000621



Gearshift and tube panel

Social-Emotional: spurs group play and conversations with its two-sidedness.

Cognitive: supports dramatic play, which stimulates language skills. Communication skills when explaining functionalities. The passing of materials through funnels supports the children's logical thinking and the understanding of object permanence.

Creative: changing the position of the gear, leaving your mark.

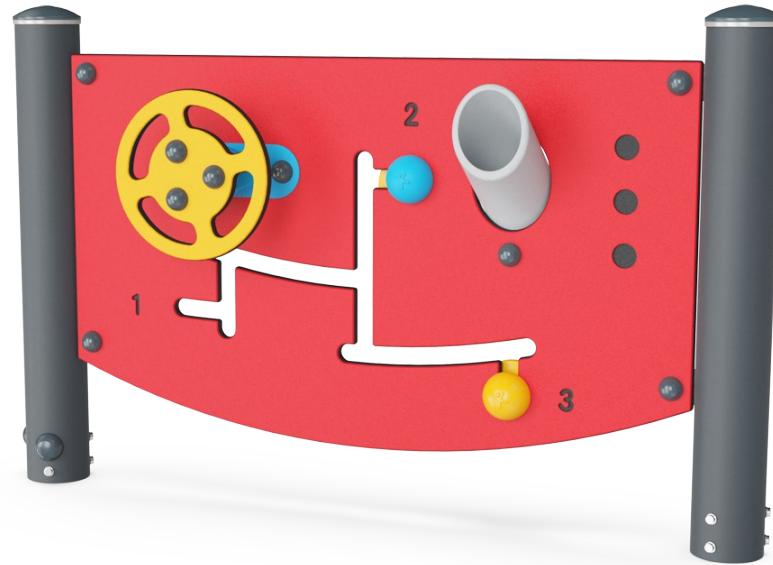

Play Panel 1 - Creative

PCM000621

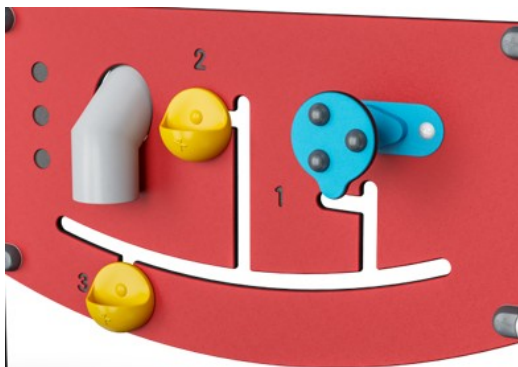

Panels of 19mm EcoCore™. EcoCore™ is a highly durable, eco friendly material, which is not only recyclable after use, but also consists of material produced from +95% recycled post consumer material from food packing waste.



Main posts with hot dip galvanized steel footing are available in different materials: Pressure impregnated pine wood posts. Pre-galvanized inside and outside with powder coated top finish steel posts. Lead free aluminum with color anodized top finish. Greenline TexMade posts of 95% post-consumer recycled PE and textile waste.

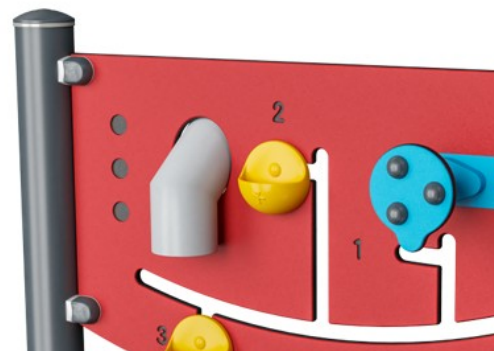

Play activities like the Funnel are made of injection moulded high quality nylon (PA6). PA6 has good wearing and impact strength and is UV stabilised.



KOMPAN GreenLine versions are designed with ultimate environmentally friendly materials with lowest possible CO2e emission factor such as EcoCore™ panels of +95% post consumer recycled ocean waste.

Item no. PCM000621-0901

Installation Information

Max. fall height	0 cm
Safety surfacing area	11.1 m ²
Total installation time	3.6
Excavation volume	0.05 m ³
Concrete volume	0.00 m ³
Footing depth (standard)	85 cm
Shipment weight	45 kg
Anchoring options	In-ground ✓ Surface ✓

Warranty Information

EcoCore HDPE	Lifetime
Hot dip galvanised steel	Lifetime
Movable parts	2 years
Post	10 years
Spare parts guaranteed	10 years



Sustainability Data

PCM000621

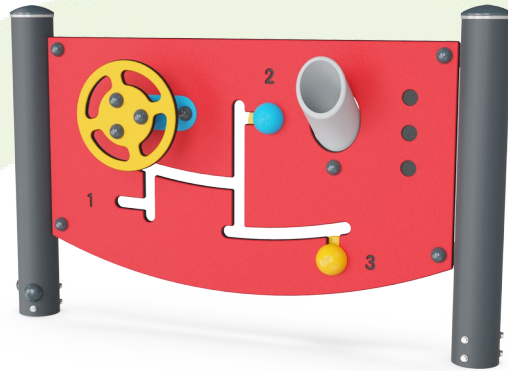

Cradle to Gate A1-A3	Total CO ₂ emission	CO ₂ e/kg	Recycled materials
	kg CO ₂ e	kg CO ₂ e/kg	%
PCM000621-0950	74.24	2.06	69.09
PCM000621-0901	82.83	2.58	58.51

The overall framework applied for these factors is the Environmental Product Declaration (EPD), which quantifies "environmental information on the life cycle of a product and enable comparisons between products fulfilling the same function" (ISO, 2006). This follows the structure and applies a Life-Cycle Assessment approach to the entire Product stage from raw material through manufacturing (A1-A3))

Kompan A/S
C.F. Tietgens Boulevard 32C
DK-5220 Odense SØ
Denmark



Verification of CO₂ calculation of: Themed play systems



Data version no. 2023-10-05

The CO₂ calculation and data are in compliance with the principles of a carbon footprint impact according to the GHG protocol (Greenhouse Gas Protocol), Scope 3, cradle to gate related to all individual components in the product category: "Themed play systems" represented by item no.: MSC641100-3717P.

(Scope 3 emissions include emission sources in the upstream and downstream value chain).

Date: 30. October 2023 | Valid until: 30. October 2025

Verified by:

Julie Marie Vejsgaard Larsen, LCA & EPD Consultant

Verification based on report: Validation of CO₂ calculation of 9 categories of Kompan product line, version 1.0, prepared by: Bureau Veritas HSE, Denmark: Julie M. V. Larsen.

Publication date: 30. October 2023

By Bureau Veritas HSE
www.bureauveritas.dk
+45 7731 1000



Play Panel 1 - Creative

PCM000621

* Max fall height | ** Total height | *** Safety surfacing area

* Max fall height | ** Total height

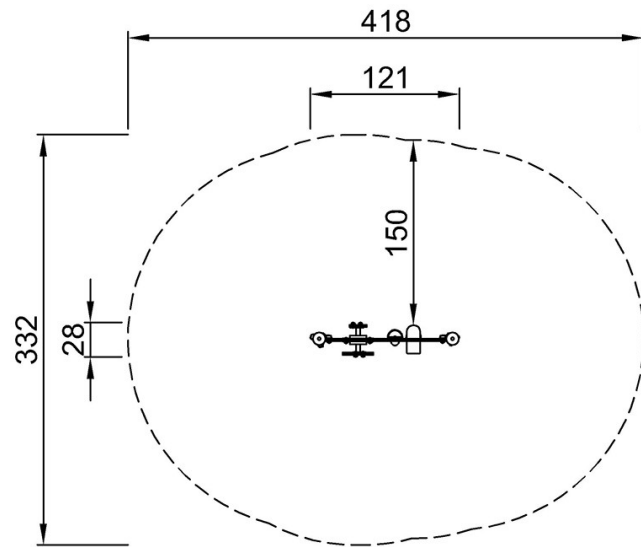

PCM000621
**75cm
***11.1m²



PCM000621

[Click to see TOP VIEW](#)

[Click to see SIDE VIEW](#)