

# Rope Nest Seat 120cm H:2.5m



SW990111



Wow! The shallow, smooth rope nest swing is a hugely inviting play activity. The soft bumpers make this a very comfortable swing seat, which is easy and pleasant to push and use. The lightweight seat welcomes users of all ages and abilities, and heaps of them at any one time, laying, standing or seated, making children return for more play again and again.

The holes in the surface provide an extra support for holding tight. The Rope Nest swinging stimulates children's motor skills, such as balance and coordination. They train core muscles as well as leg and arm muscles when pulling and pushing the swing into motion. The basket invites rough-and-tumble play and stimulates important socio-emotional

skills: turn-taking and cooperation. These are crucial life skills, fun to learn in play.

Item no. SW990111-03	
<b>General Product Information</b>	
Dimensions LxWxH	193x124x0 cm
Age group	2+
Play capacity (users)	7
Color options	  

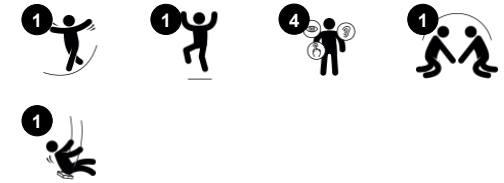

# Rope Nest Seat 120cm H:2.5m

SW990111



KOMPAN designed the bird's nest seats to be light in weight and in compliance with global safety standards. The soft, shock absorbent bumpers with non-slip surface makes the swing seat extremely user friendly. Choose between a rope version with reinforced PA rope or a moulded PE version. Both equipped with soft rubber bumpers.

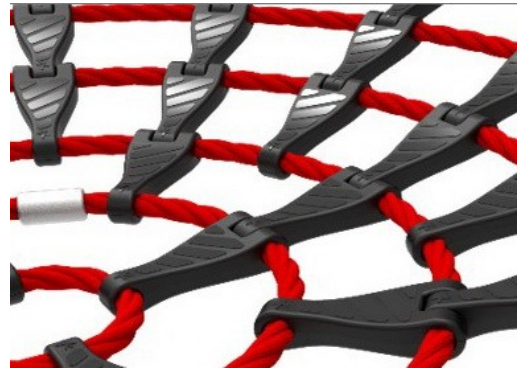

Rope loops of the seat are made of single braided 16 mm PES ropes. PES has high strength with excellent resistance to abrasion and UV radiation. The rope loops are connected by nylon (PA6) connectors.



The bumpers are made with a core of strong polypropylene (PP) with a softer outer layer of thermoplastic rubber (TPE). The soft, shock absorbent bumpers with non slip surface makes the swing seat extremely user friendly.

Item no. SW990111-03	
Installation Information	
Max. fall height	143 cm
Safety surfacing area	18.9 m <sup>2</sup>
Total installation time	0.5
Excavation volume	0.00 m <sup>3</sup>
Concrete volume	0.00 m <sup>3</sup>
Footing depth (standard)	0 cm
Shipment weight	40 kg
Anchoring options	



KOMPAN heavy duty designed swing hangers of stainless steel with anti-twist function. The hangers are attached to the cross beam on a welded bracket with two bolts, The bearings are embedded with silicone lubricant and needs no further lubrication.



Upper chain and safety chain are made of high quality stainless steel to ensure durability of the product.



Ropes are made of UV-stabilised PA with inner steel cable reinforcement. The rope is induction treated in order to create a strong connection between steel and rope which leads to good wear resistance.



# Sustainability Data

SW990111



## Cradle to Gate A1-A3

## Total CO<sub>2</sub> emission

## CO<sub>2</sub>e/kg

## Recycled materials

kg CO<sub>2</sub>e

kg CO<sub>2</sub>e/kg

%

SW990111-03

193.00

5.36

21.80

The overall framework applied for these factors is the Environmental Product Declaration (EPD), which quantifies "environmental information on the life cycle of a product and enable comparisons between products fulfilling the same function" (ISO, 2006). This follows the structure and applies a Life-Cycle Assessment approach to the entire Product stage from raw material through manufacturing (A1-A3))

### Kompan A/S

C.F. Tietgens Boulevard 32C  
DK-5220 Odense SØ  
Denmark



### Verification of CO<sub>2</sub> calculation of: Freestanding play equipment



Data version no. 2023-10-05

The CO<sub>2</sub> calculation and data are in compliance with the principles of a carbon footprint impact according to the GHG protocol (Greenhouse Gas Protocol), Scope 3, cradle to gate related to all individual components in the product category: "Freestanding play equipment" represented by item no.: KSW92011-0910.

(Scope 3 emissions include emission sources in the upstream and downstream value chain).

**Date: 30. October 2023 | Valid until: 30. October 2025**

Verified by:

Julie Marie Vejsgaard Larsen, LCA & EPD Consultant

Verification based on report: Validation of CO<sub>2</sub> calculation of 9 categories of Kompan product line, version 1.0, prepared by: Bureau Veritas HSE, Denmark: Julie M. V. Larsen.

**Publication date: 30. October 2023**

By Bureau Veritas HSE

www.bureauveritas.dk

+45 7731 1000



# Rope Nest Seat 120cm H:2.5m

SW990111

\* Max fall height | \*\* Total height | \*\*\* Safety surfacing area

\* Max fall height | \*\* Total height

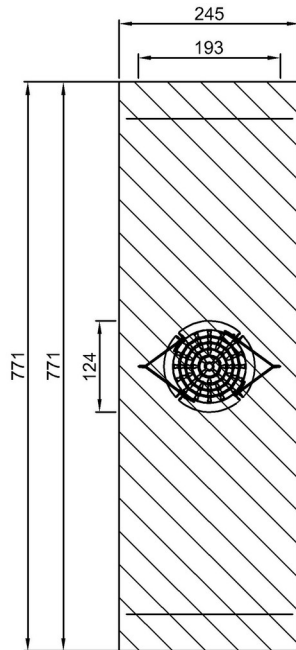

SW990111  
\*\*\*18.9m<sup>2</sup>

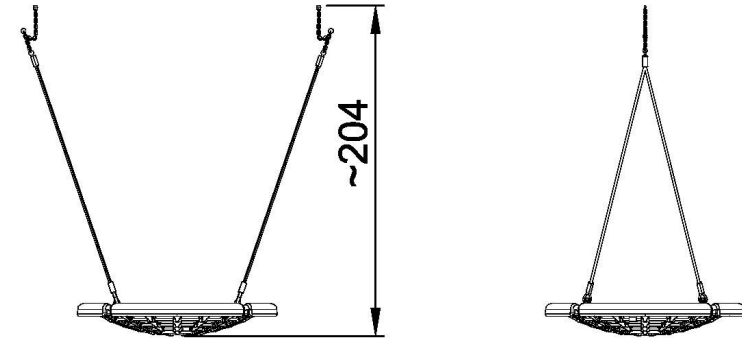

SW990111  
1:100

[Click to see TOP VIEW](#)

[Click to see SIDE VIEW](#)