

# Adara II

GXY950

**KOMPANI**  
Let's play

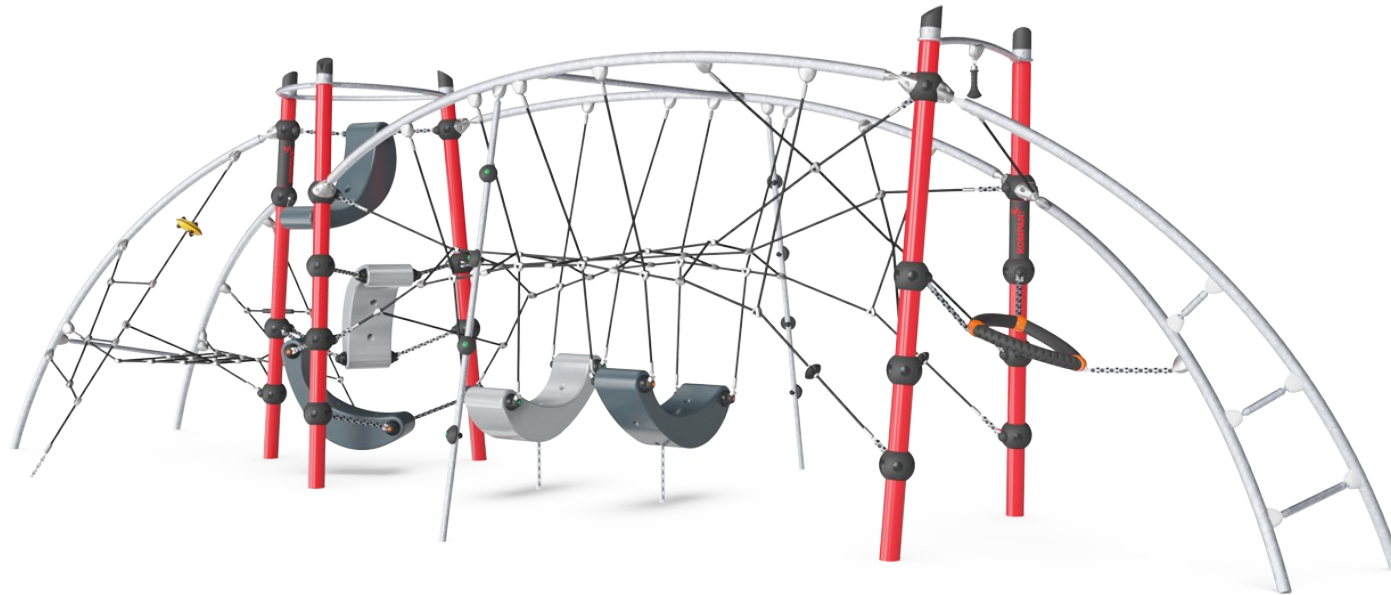

产品编号 GXY950032-3717

## 产品信息概览

长宽高尺寸	927x293x265 cm
适用年龄段	6+
容纳人数	21
颜色选择	

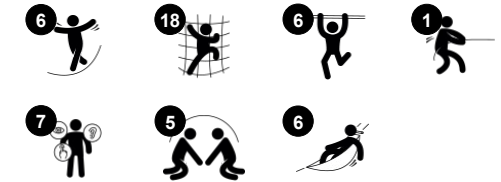

Adara II, with its spacious nets and swaying, bouncy play destinations attract and cater for heaps of playful children meeting and socializing. The rope, play shell and climbing details support varied body positions, thus catering for a wide span of ability levels. The responsiveness of the activities are fundamental motivation factors for play. The

interconnectedness of the nets and play shells means that the childrens' movements are felt throughout the net activities. At the ends, bouncy or swaying play items invite smaller group meetings. The intense physical feedback of the Adara II supports physical and social interaction for big groups. This supports the teenagers' wish for being with all their friends.

The climbing and bouncing in Adara II train their balance, proprioception and spatial awareness intensely. All skills needed for self confidence in moving.

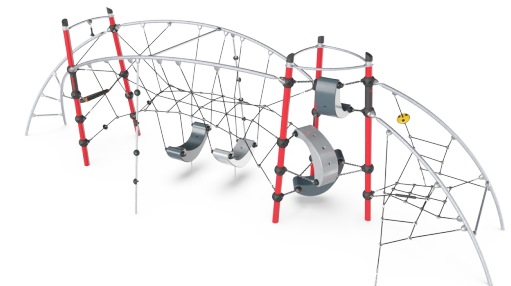

# Adara II

GXY950



## Twisted ladder

**身体素质：**agility, balance and coordination. Muscle strength when swinging up for gripping handle. **社交情感：**resting point, turn-taking and socializing.

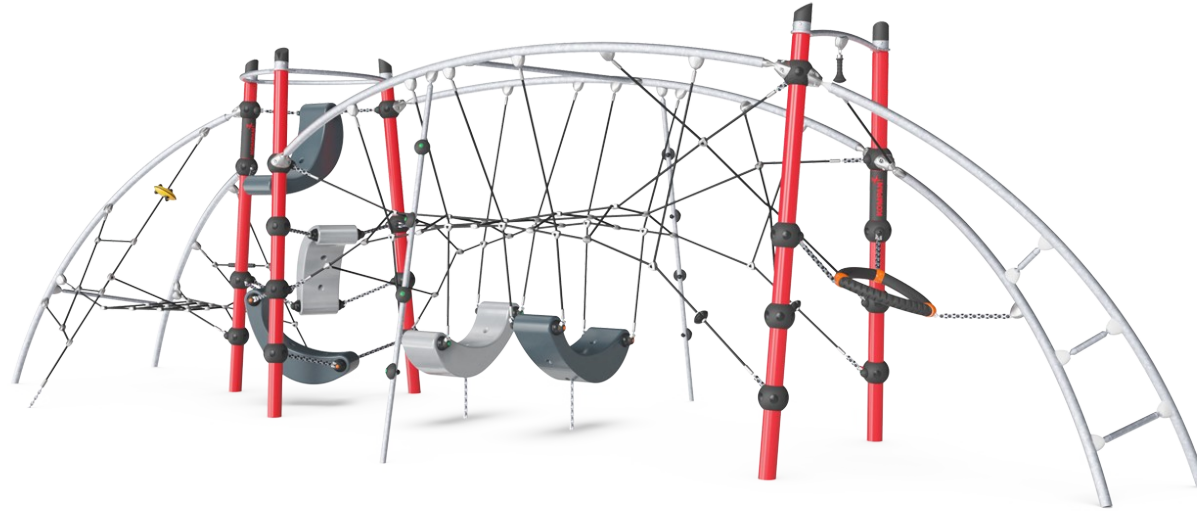

## 游戏座椅

**身体素质：**摇摆动作能刺激平衡感，对于在椅子上静坐的能力非常重要。 **社交情感：**可以在这里汇合、休息和轮流发言，这是学习如何避免冲突的必要技能。



## Catena link

**身体素质：**弹跳式爬行和攀爬有助于发展交叉协调能力、平衡能力和空间意识。 **社交情感：**宽敞的空间，各种活动相互关联，鼓励更多人的聚会。这是青少年的最爱，能重新肯定他们的归属感。



## Open triangle plate

**身体素质：**在向上攀爬/通过时，手臂、腿部和核心肌肉都会得到锻炼。此外，还有助于培养身体的直觉和空间感，这两种运动技能都有助于培养身体在空间中的方向感。 **社交情感：**摇摇晃晃、充满弹性的座椅，供休息之用，还可以邀请人们进行社交和轮流参与。



## Net

**身体素质：**cross coordination when climbing or crawling in the net. This supports the cooperation of left and right brain half, important for other skills such as reading. **社交情感：**taking a break together in the net and waiting for others to cross supports social abilities such as cooperation and communication.



## Play shell climber

**身体素质：**swaying response to movement makes for challenging climbs and nice seating. **社交情感：**socializing in smaller groups and turn-taking when deciding who should sit here.

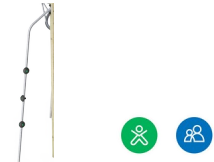

## Climbing pole

**身体素质：**训练交叉协调能力、手眼协调能力和肌肉力量。 **社交情感：**训练轮流发言和自我调节能力等重要生活技能。

# Adara II

GXY950



钢表面内外均采用无铅热镀锌镀层，户外耐蚀性高，维护成本低。



大型活动区域由 100 % 可回收的 PE 制成。所展示的游戏贝壳被模制成为整体，最小壁厚为 5mm。PE 在很宽的温度范围内具有很高的抗冲击性，确保在全球所有气候条件下的防破坏性能。



GALAXY 攀登三角架，带有 PUR 的外部软层和模制尼龙（PA6）的角支架。芯部由带有集成角部悬挂点的粉末涂层焊接钢框架组成。较大的三角形由一块 18mm 厚的 Ekogrip® 面板封闭，该面板具有一层橡胶，具有防滑效果。



GALAXY 绳索具有六股钢丝和钢丝芯。每根丝束都用 PES 纱紧密包裹，然后将其融化到每根单独的丝束上。在最初的摩擦力去除了表面纤维之后，保留了较硬的 PES 涂层以保护每根股绳，从而使绳索具有极高的耐磨性和防破坏性。



设计独特的 GALAXY 连接球由铝制的内部圆形芯制成，周围由硬质 PP 外壳和软性 TPV 橡胶外层包围。柔性无铅铝连接部件允许以可变角度安装



Galaxy 产品有不同的颜色组合，可以进行热浸镀锌钢板表面处理，也可以选择使用精选钢部件的粉末表面处理。游戏活动部分的颜色可调整，以符合各个颜色组合。

产品编号 GXY950032-3717

## 安装信息

最大跌落高度	249 cm
安全面积	62.2 m <sup>2</sup>
安装总时长	22.5
开挖量	5.30 m <sup>3</sup>
混凝土使用量	1.92 m <sup>3</sup>
标准入地深度	90 cm
运输重量	786 kg
固定选项	入地 ✓ 地表 ✓

## 质保信息

Galaxy 连接球	5 年
镀锌钢结构	终身质保
PUR 部件	10 年
绳网	10 年
承保零部件	10 年



# Sustainability Data

GXY950

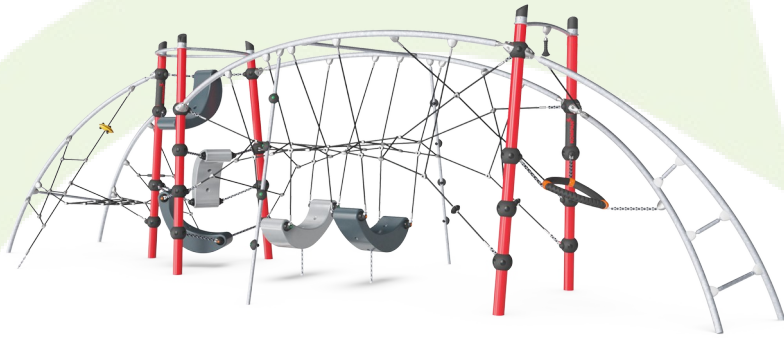

从原材料到成品

CO<sub>2</sub> 排放总量

CO<sub>2</sub> 排放量 / 千克

回收的原料

kg CO<sub>2</sub>e

kg CO<sub>2</sub>e/kg

%

GXY950032-3717

2,176.80

3.53

37.40

这些因素采用的总体框架为环保产品声明 (EPD), 该声明可量化“产品生命周期的环保信息, 并对相同功能的产品进行对比” (ISO, 2006)。在遵循该框架的同时, 对从原材料到制造的整个产品阶段 (A1-A3) 应用生命周期评估法。

**Kompan A/S**

C.F. Tietgens Boulevard 32C  
DK-5220 Odense SØ  
Denmark



**Verification of CO<sub>2</sub> calculation of:  
Challengers & Climbers**

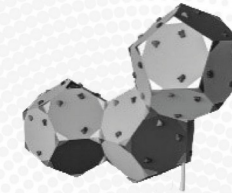

Data version no. 2023-10-05

The CO<sub>2</sub> calculation and data are in compliance with the principles of a carbon footprint impact according to the GHG protocol (Greenhouse Gas Protocol), Scope 3, cradle to gate related to all individual components in the product category: "Challengers & Climbers" represented by item no.: BLX410301-3717.

(Scope 3 emissions include emission sources in the upstream and downstream value chain).

**Date: 30. October 2023 | Valid until: 30. October 2025**

Verified by:

Julie Marie Vejsgaard Larsen, LCA & EPD Consultant

Verification based on report: Validation of CO<sub>2</sub> calculation of 9 categories of Kompan product line, version 1.0, prepared by: Bureau Veritas HSE, Denmark: Julie M. V. Larsen.

**Publication date: 30. October 2023**

By Bureau Veritas HSE  
www.bureauveritas.dk  
+45 7731 1000



# Adara II

GXY950

最大跌落高度 | 总高度 | 安全区域

最大跌落高度 | 总高度

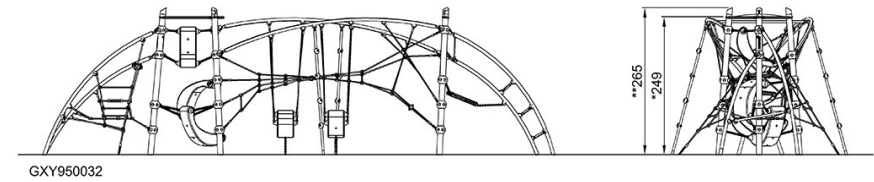
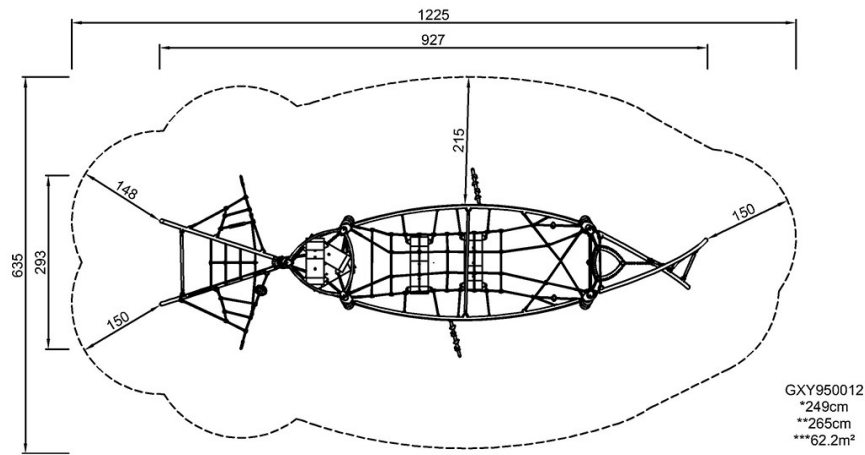

[点击查看俯视图](#)

[点击查看侧面图](#)