

Ocean & Jungle with Net Tower

MSC6410

Item no. MSC641000-3717P	
General Product Information	
Dimensions LxWxH	27'3"x15'6"x9'5"
Age group	2 - 5
Play capacity (users)	32
Color options	●

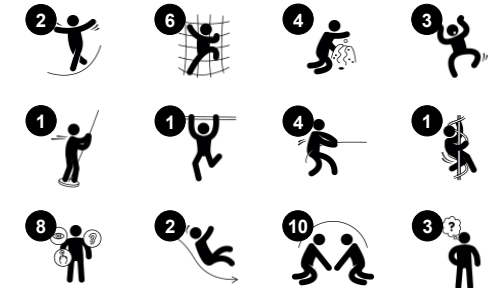

WOW! The roomy Ocean & Jungle themes hugely appeal to children's urge for dramatic play stories. The under deck den invites a break with friends. There is an Ocean side and a Jungle side, inspiring play stories. Thanks to the two-sided panels and themes and the varied accesses: curved, straight and net climbers, the Ocean & Jungle challenge a wide

user groups. The climbing events and the slide train motor skills, such as cross-coordination and balance, important for navigating the world confidently. The meeting points are many, as the Ocean & Jungle can be played from all sides. The huge net adds volume and active meeting. From the upper level, children can look communicate through the window with

ground level. So the social play invitation is immense. Children meet, greet and play, making friends for life.

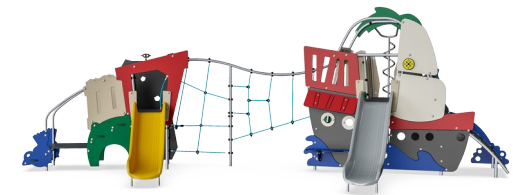

Ocean & Jungle with Net Tower

MSC6410



Binoculars

Cognitive: the binoculars set a tangible theme and so spur dramatic play. Dramatic play is great for developing language and communication skills. **Creative:** the binoculars can be turned in all directions. Looking through them gives a new perspective on the world.

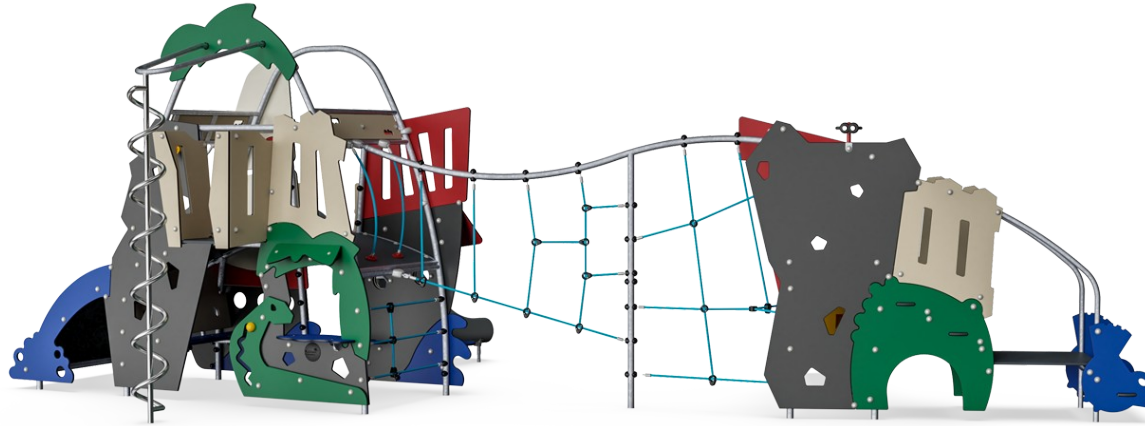

Den

Physical: crawling through the possible openings trains spatial awareness. **Social-Emotional:** the enclosed space invites social play for two or three children.



Accessible stairway

Physical: climbing the accessible stairway is for all and supports cross coordination as well as arm and leg muscles. For young children, walking stairs and alternating feet is developed. **Social-Emotional:** room for active breaks and adult helpers. An inclusive space.



Slide

Physical: sliding develops spatial awareness and a sense of balance. Furthermore, the core muscles are trained when sitting upright going down. **Social-Emotional:** empathy stimulated by turn-taking. **Cognitive:** young children develop their understanding of space, speed and distances when sliding down quickly.



Climbing net

Physical: children develop cross-body coordination and muscle strength. The asymmetry of the net challenges the children's climbing.



Curly climber

Physical: coordination and proprioception are supported when placing arms and legs correctly for going down. Sense of balance when rotating. Arm muscles for holding tight. **Social-Emotional:** empathy stimulated by turn-taking. **Cognitive:** logical thinking when placing arms and legs right for rotating downward.



Megaphone

Social-Emotional: inspires communication and turn-taking skills. **Cognitive:** distortion of sound evokes curiosity and stimulates an understanding of cause and effect.

Ocean & Jungle with Net Tower

MSC6410

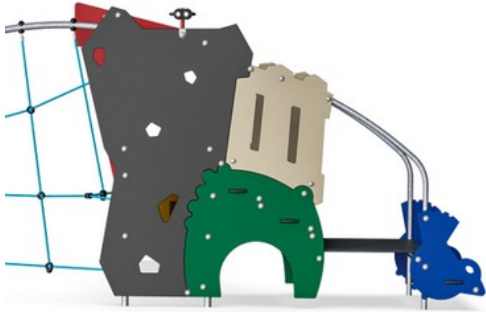

Panels of 19mm EcoCore™. EcoCore™ is a highly durable, eco friendly material, which is not only recyclable after use, but also consists of a core produced from 100% recycled material.



All floors are made of High-Pressure Laminate HPL with a thickness 17.8mm and non skid surface texture according to EN 438-6. KOMPAN HPL has high wearing strength to ensure long lifetime in all climates.

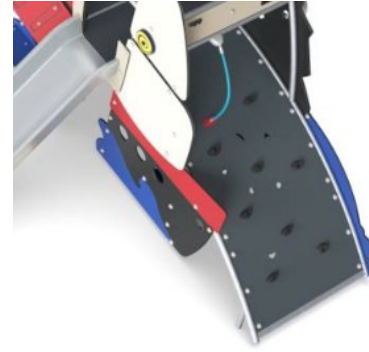

Curved climbing wall is made of Ekogrip® panel that consist of a 15mm thick PE base with 3 mm top-layer of soft rubber with a non-skid effect.



The slide is made of molded PE. PE has high impact resistance across a wide temperature span which ensures vandal resistance in all locations.



Ropes are made of UV-stabilized PP rope strands with inner steel cable reinforcement. Horizontal ropes are PUR coated to obtain good wear and tear resistance.

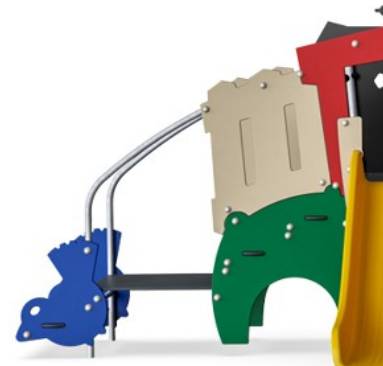

The steel surfaces are hot-dip galvanized inside and outside with lead-free zinc. The galvanization has excellent corrosion resistance in outside environments and requires minimal maintenance.

Item no. MSC641000-3717P

Installation Information

Max. fall height	7'5"
Safety surfacing area	728ft ²
Total installation time	32.1
Excavation volume	2.01yd ³
Concrete volume	0yd ³
Footing depth (standard)	2'11"
Shipment weight	2132lbs
Anchoring options	In-ground ✓ Surface ✓

Warranty Information

EcoCore HDPE	Lifetime
Hot dip galvanized steel	Lifetime
HPL decks	15 Years
Ropes & nets	10 Years
Spare Parts Availability	10 Years

Elevated activities 9	Accessible elevated activities	Accessible ground level activities	Accessible ground level play types
Present	9	6	4
Required	5	3	3

ASTM F1487
compliant

Sustainability Data

MSC6410

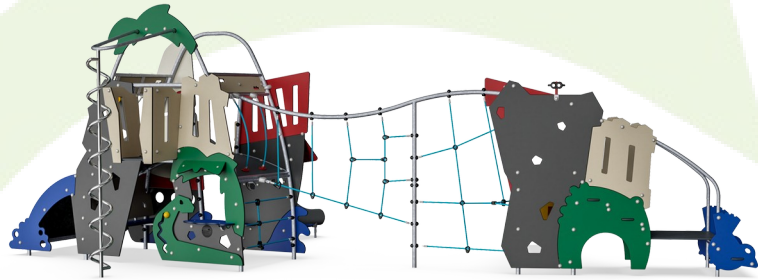

Cradle to Gate A1-A3	Total CO ₂ emission	CO ₂ e/kg	Recycled materials
	kg CO ₂ e	kg CO ₂ e/kg	%
MSC641000-3717P	1,893.02	2.25	53.86

The overall framework applied for these factors is the Environmental Product Declaration (EPD), which quantifies "environmental information on the life cycle of a product and enable comparisons between products fulfilling the same function" (ISO, 2006). This follows the structure and applies a Life-Cycle Assessment approach to the entire Product stage from raw material through manufacturing (A1-A3))

Kompan A/S
 C.F. Tietgens Boulevard 32C
 DK-5220 Odense SØ
 Denmark



Verification of CO₂ calculation of: Themed play systems

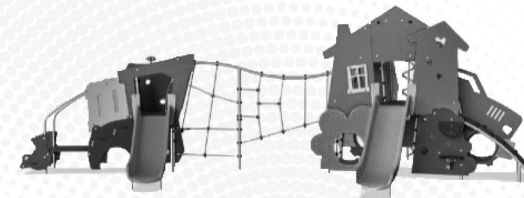

Data version no. 2023-10-05

The CO₂ calculation and data are in compliance with the principles of a carbon footprint impact according to the GHG protocol (Greenhouse Gas Protocol), Scope 3, cradle to gate related to all individual components in the product category: "Themed play systems" represented by item no.: MSC641100-3717P.

(Scope 3 emissions include emission sources in the upstream and downstream value chain).

Date: 30. October 2023 | Valid until: 30. October 2025

Verified by:

Julie Marie Vejsgaard Larsen, LCA & EPD Consultant

Verification based on report: Validation of CO₂ calculation of 9 categories of Kompan product line, version 1.0, prepared by: Bureau Veritas HSE, Denmark: Julie M. V. Larsen.

Publication date: 30. October 2023

By Bureau Veritas HSE
 www.bureauveritas.dk
 +45 7731 1000



Ocean & Jungle with Net Tower

MSC6410

* Max fall height | ** Total height | *** Safety surfacing area

* Max fall height | ** Total height

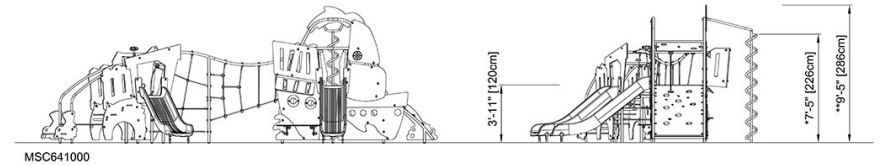
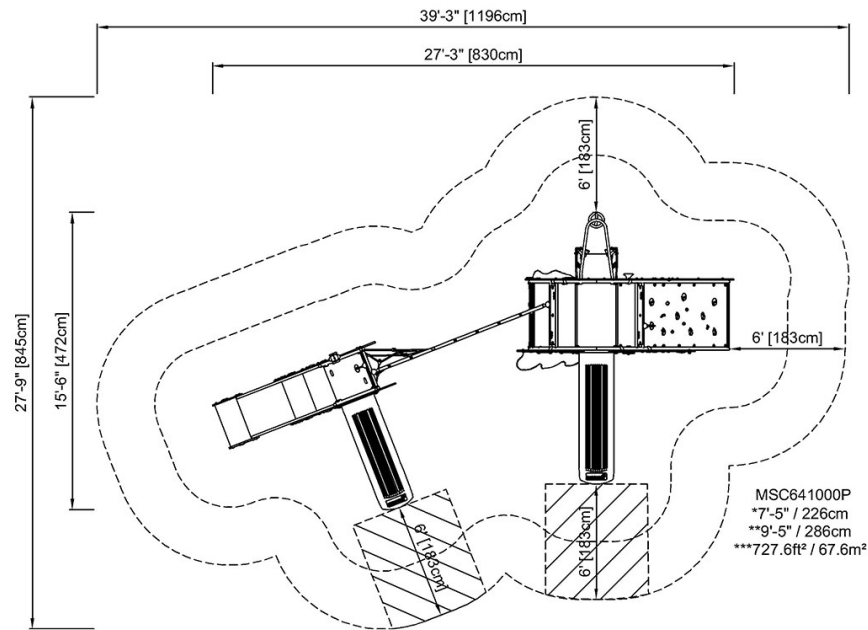

[Click to see TOP VIEW](#)

[Click to see SIDE VIEW](#)