

Peekaboo Tunnel

PCM002921



Item no. PCM002921-0601	
General Product Information	
Dimensions LxWxH	87x160x100 cm
Age group	6m+
Play capacity (users)	3
Color options	



Peek-a-boo games are classic fun for young children and are natural learning opportunities. The peek-a-boo tunnel encourages these games which help the younger children to explore concepts related to object awareness (people and objects remain present after we cannot see them) as well as perspective and how pure fun is related to surprise. The tunnel

also supports the physical dimension of this kind of play by encouraging crawling through and moving around. This helps to develop motor skills such as coordination and awareness. The holes in the tunnel allows for interaction with the children on ground level. The structure also supports dramatic play and imagination and stimulates language and

communication skills in the children. Lots of play in a simple structure, designed with play in mind.

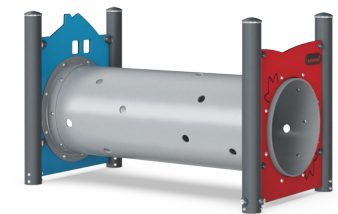

Peekaboo Tunnel

PCM002921



Panels of 19mm EcoCore™. EcoCore™ is a highly durable, eco friendly material, which is not only recyclable after use, but also consists of material produced from +95% recycled post consumer material from food packing waste.



Main posts with hot dip galvanized steel footing are available in different materials: Pressure impregnated pine wood posts. Pre-galvanized inside and outside with powder coated top finish steel posts. Lead free aluminum with color anodized top finish. Greenline TexMade posts of 95% post-consumer recycled PE and textile waste.

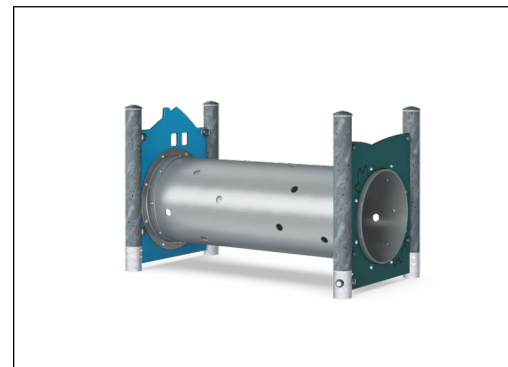

KOMPAN GreenLine versions are designed with ultimate environmentally friendly materials with lowest possible CO2e emission factor such as EcoCore™ panels of +95% post consumer recycled ocean waste.

Item no. PCM002921-0601

Installation Information

Max. fall height	15 cm
Safety surfacing area	14.2 m ²
Total installation time	4.6
Excavation volume	0.08 m ³
Concrete volume	0.00 m ³
Footing depth (standard)	60 cm
Shipment weight	96 kg
Anchoring options	



Sustainability Data

PCM002921

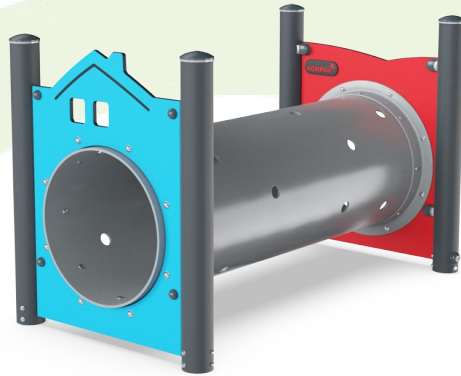

Cradle to Gate A1-A3	Total CO ₂ emission	CO ₂ e/kg	Recycled materials
	kg CO ₂ e	kg CO ₂ e/kg	%
PCM002921-0650	152.30	1.81	63.50
PCM002921-0601	181.90	2.49	49.30

The overall framework applied for these factors is the Environmental Product Declaration (EPD), which quantifies "environmental information on the life cycle of a product and enable comparisons between products fulfilling the same function" (ISO, 2006). This follows the structure and applies a Life-Cycle Assessment approach to the entire Product stage from raw material through manufacturing (A1-A3))

Kompan A/S
 C.F. Tietgens Boulevard 32C
 DK-5220 Odense SØ
 Denmark



Verification of CO₂ calculation of: Themed play systems

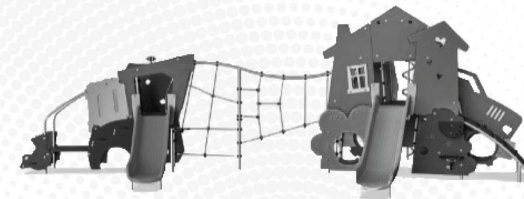

Data version no. 2023-10-05

The CO₂ calculation and data are in compliance with the principles of a carbon footprint impact according to the GHG protocol (Greenhouse Gas Protocol), Scope 3, cradle to gate related to all individual components in the product category: "Themed play systems" represented by item no.: MSC641100-3717P.

(Scope 3 emissions include emission sources in the upstream and downstream value chain).

Date: 30. October 2023 | Valid until: 30. October 2025

Verified by:

Julie Marie Vejsgaard Larsen, LCA & EPD Consultant

Verification based on report: Validation of CO₂ calculation of 9 categories of Kompan product line, version 1.0, prepared by: Bureau Veritas HSE, Denmark: Julie M. V. Larsen.

Publication date: 30. October 2023

By Bureau Veritas HSE
 www.bureauveritas.dk
 +45 7731 1000



Peekaboo Tunnel

PCM002921

* Max fall height | ** Total height | *** Safety surfacing area

* Max fall height | ** Total height

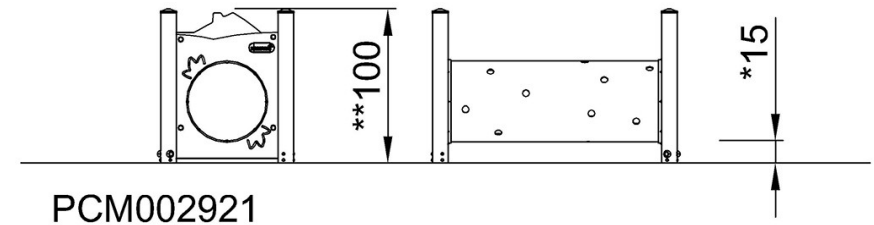
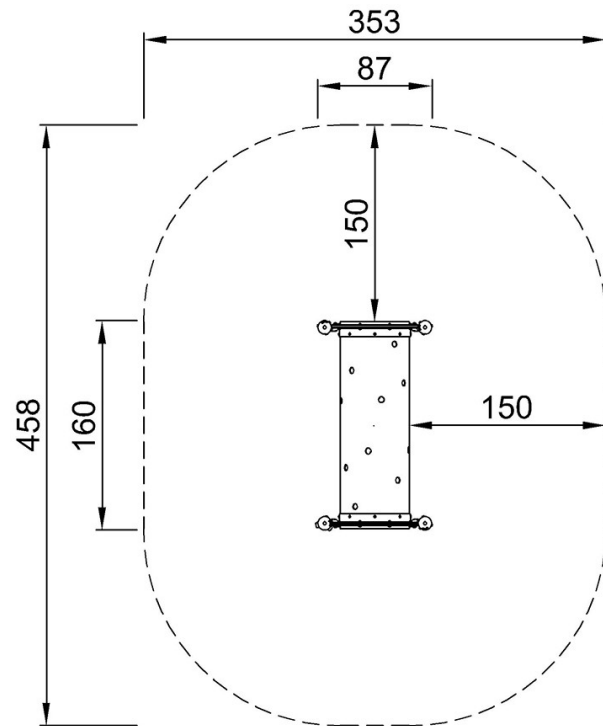

PCM002921
*15cm
**100cm
***14.2m²

[Click to see TOP VIEW](#)

[Click to see SIDE VIEW](#)