

Bench S 60cm

FRE3013

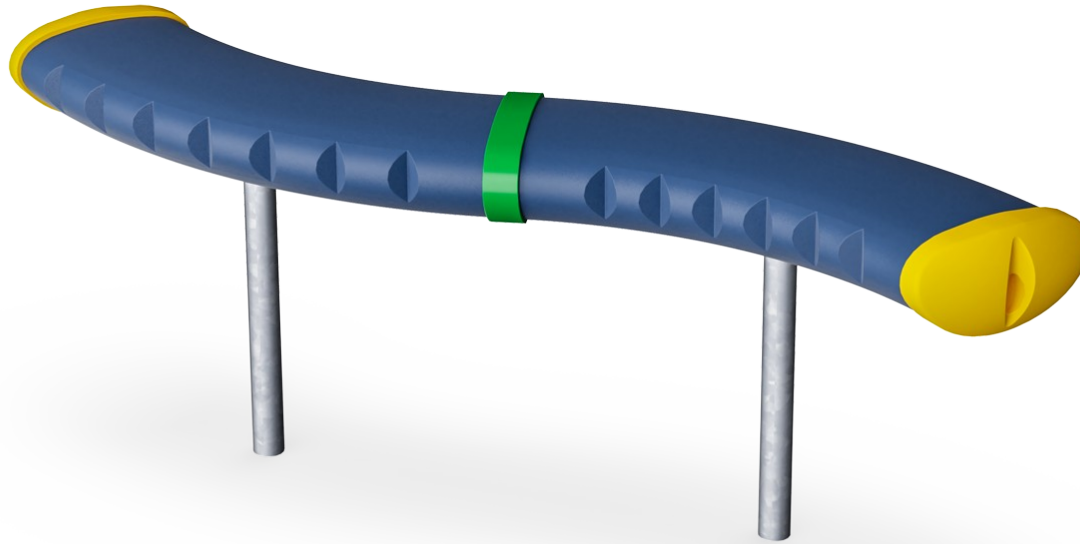

产品编号 FRE3013-3417

产品信息概览

长宽高尺寸	147x96x61 cm
适用年龄段	3+
容纳人数	-
颜色选择	

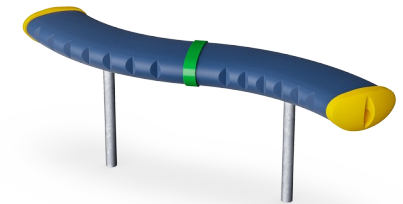

弧形的 Benches 可以安装在不同高度，也可以相邻安装，形成一个护栏。它是一个绝佳的聚会点，孩子们既能与朋友们进行社交，又能同时观看体育活动。



Bench S 60cm

FRE3013

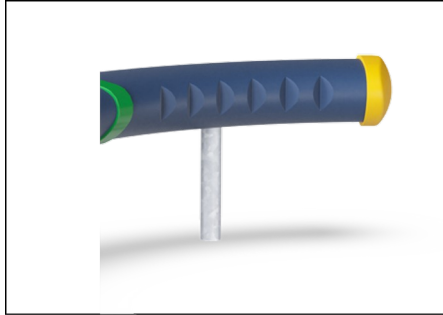

钢表面内外均采用无铅热镀锌镀层，户外耐蚀性高，维护成本低。

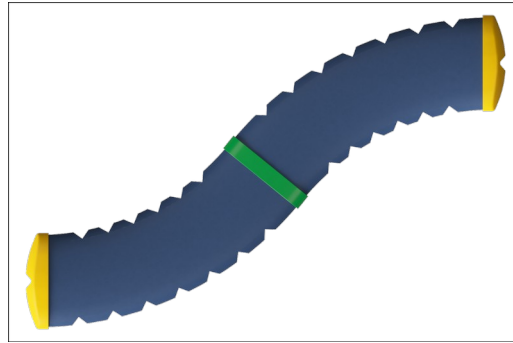

The large components are made of 100% recyclable PE made from 33% post consumer materials. Molded in one piece with minimum 5mm wall thickness to ensure high durability in all climates around the world.



KOMPAN 环保系列产品采用终极环保材料设计，具有将二氧化碳排放当量系数降至最低的可能性。如 100% 消费后的海洋可循环材料制成的 EcoCore™ 面板。

产品编号 FRE3013-3417

安装信息

最大跌落高度	0 cm
安全面积	0.0 m ²
安装总时长	1.9
开挖量	0.29 m ³
混凝土使用量	0.10 m ³
标准入地深度	60 cm
运输重量	32 kg
固定选项	入地 ✓ 地表 ✓

质保信息

中空 PE 聚乙烯部件	10 年
镀锌钢结构	终身质保
承保零部件	10 年



Sustainability Data

FRE3013

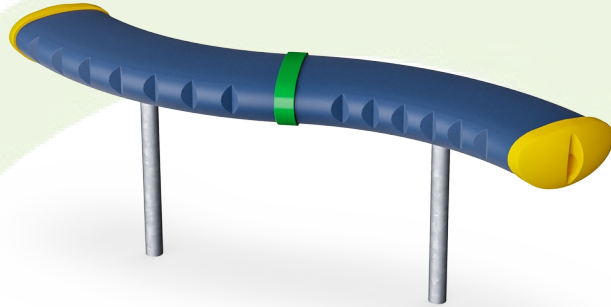

从原材料到成品

CO₂ 排放总量

kg CO₂e

CO₂ 排放量 / 千克

kg CO₂e/kg

回收的原料

%

FRE3013-3417

73.13

2.28

34.61

这些因素采用的总体框架为环保产品声明 (EPD), 该声明可量化“产品生命周期的环保信息, 并对相同功能的产品进行对比”(ISO, 2006)。在遵循该框架的同时, 对从原材料到制造的整个产品阶段 (A1-A3) 应用生命周期评估法。

Kompan A/S

C.F. Tietgens Boulevard 32C
DK-5220 Odense SØ
Denmark



Verification of CO₂ calculation of: Park

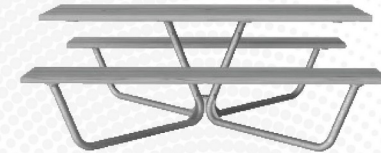

Data version no. 2023-10-05

The CO₂ calculation and data are in compliance with the principles of a carbon footprint impact according to the GHG protocol (Greenhouse Gas Protocol), Scope 3, cradle to gate related to all individual components in the product category: "Park" represented by item no.: PAR4070-0001.

(Scope 3 emissions include emission sources in the upstream and downstream value chain).

Date: 30. October 2023 | Valid until: 30. October 2025

Verified by:

Julie Marie Vejsgaard Larsen, LCA & EPD Consultant

Verification based on report: Validation of CO₂ calculation of 9 categories of Kompan product line, version 1.0, prepared by: Bureau Veritas HSE, Denmark: Julie M. V. Larsen.

Publication date: 30. October 2023

By Bureau Veritas HSE
www.bureauveritas.dk
+45 7731 1000



Bench S 60cm

FRE3013

最大跌落高度 | 总高度 | 安全区域

最大跌落高度 | 总高度

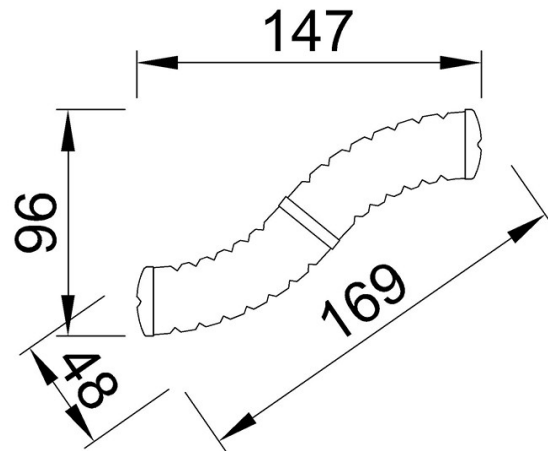

FRE3013
**61cm



FRE3013

[点击查看俯视图](#)

[点击查看侧面图](#)