

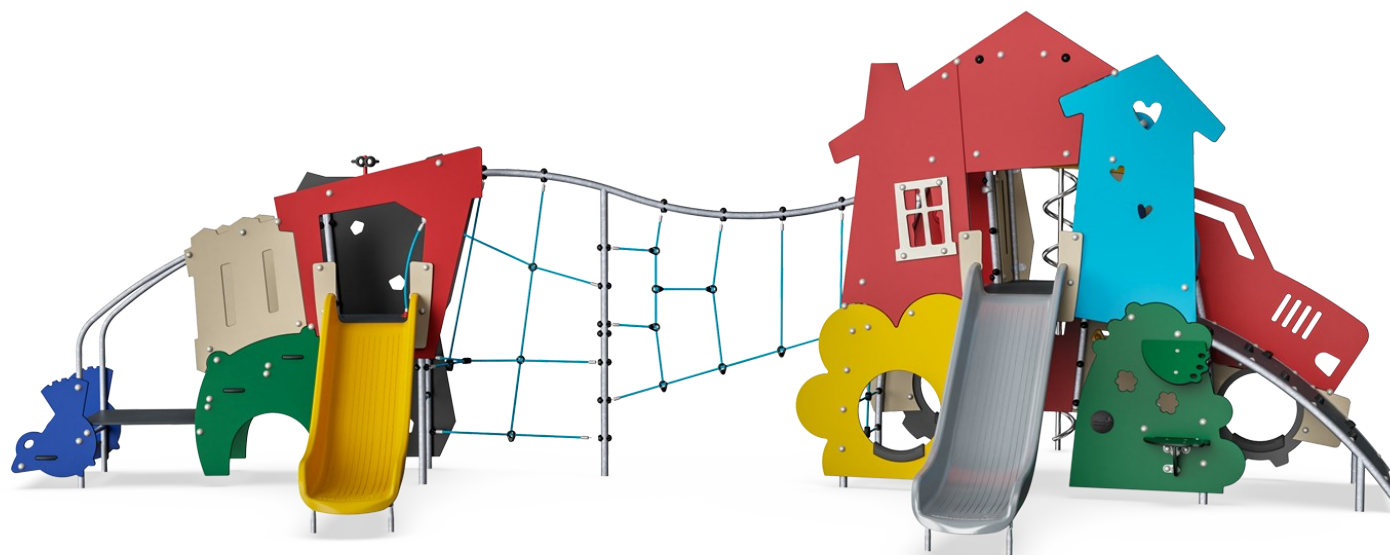

# Home & Rescue with Net Tower

MSC6411



Item no. MSC641100-3717P	
General Product Information	
Dimensions LxWxH	823x472x285 cm
Age group	2+
Play capacity (users)	30
Colour options	

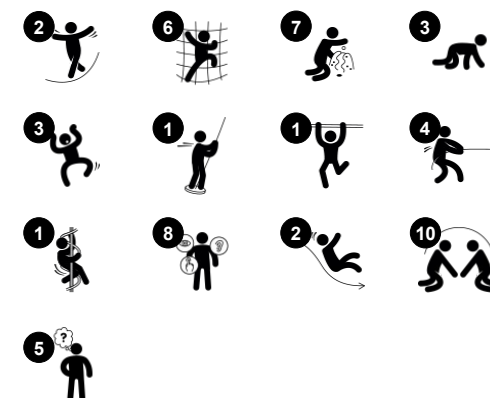

WOW! The roomy Home & Rescue themes hugely appeal to children's dramatic play stories. The ground level den invites a break time with friends. There is a Home side and a Rescue side, inspiring vigorous play stories. Thanks to the two-sided themed panels and the varied climbers: curved, round, straight and net climbers, there are challenges for a wide

user group. The climbing events, slides and glides train motor skills, such as cross-coordination and balance, important for navigating the world confidently. The meeting points are many, as the Home & Rescue can be played from all sides. The huge net adds volume and active meeting. From the upper level, children can look communicate through

the window with ground level. So the social play invitation is immense. Children meet, greet and play, making friends for life.

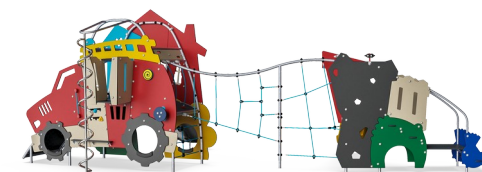

# Home & Rescue with Net Tower

MSC6411



## Binoculars

**Cognitive:** the binoculars set a tangible theme and thus spur dramatic play. Dramatic play is a great trainer of language and communication skills. **Creative:** the binoculars can be turned in all directions. Looking through them gives a new perspective on the world.

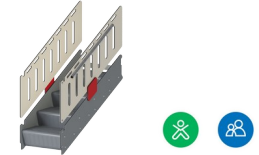
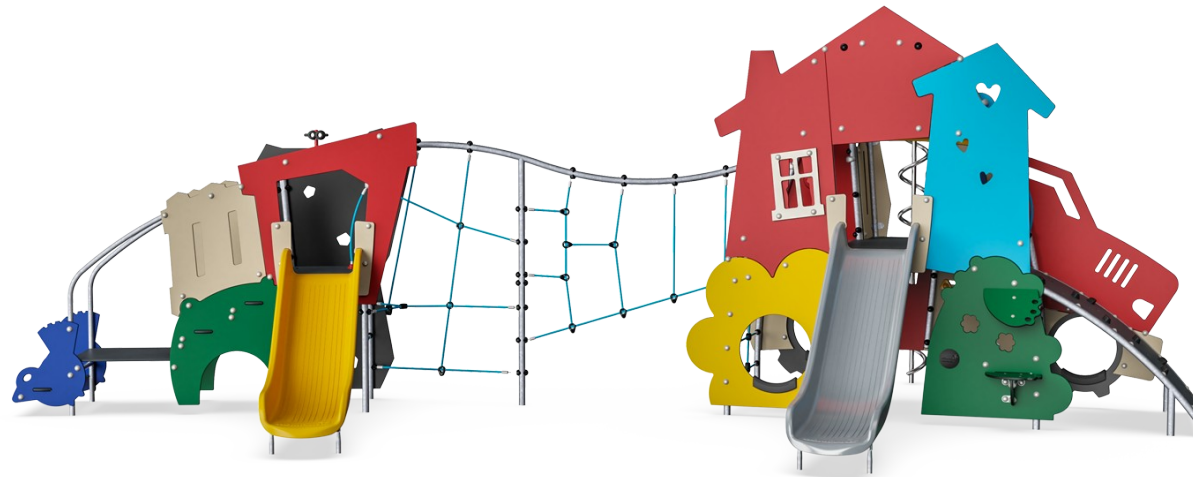

## Accessible stairway

**Physical:** climbing the accessible stairway is for all and supports cross coordination as well as arm and leg muscles. For young children, walking stairs and alternating feet is developed. **Social-Emotional:** room for active breaks and adult helpers. An inclusive space.



## Climbing net

**Physical:** children develop cross-body coordination and muscle strength. The asymmetry of the net challenges the children's climbing.



## Curly climber

**Physical:** coordination and proprioception are supported when placing arms and legs correctly for going down. Sense of balance when rotating. Arm muscles for holding tight. **Social-Emotional:** empathy stimulated by turn-taking. **Cognitive:** logical thinking when placing arms and legs right for rotating downwards.



## Den

**Physical:** crawling through the possible openings trains spatial awareness. **Social-Emotional:** the enclosed space invites social play for two or three children.



## Crawl-through hole

**Physical:** the hole allows for climbing and crawling through, developing cross coordination, proprioception and spatial awareness. **Social-Emotional:** cooperation and turn-taking when passing one another. **Cognitive:** understanding space, shape and measures when seeing if the body can fit through the hole.



## Slide

**Physical:** sliding develops spatial awareness and a sense of balance. Furthermore, the core muscles are trained when sitting upright going down. **Social-Emotional:** empathy stimulated by turn-taking. **Cognitive:** young children develop their understanding of space, speed and distances when sliding down quickly.

# Home & Rescue with Net Tower

MSC6411



Panels of 19mm EcoCore™. EcoCore™ is a highly durable, eco friendly material, which is not only recyclable after use, but also consists of material produced from +95% recycled post consumer material from food packing waste.

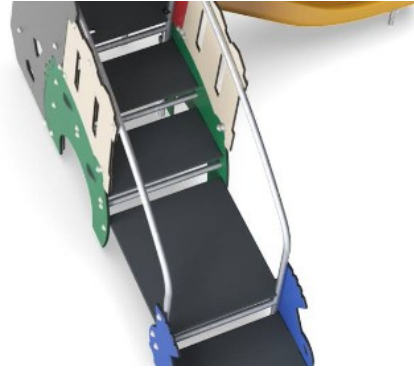

All floors are made of High-Pressure Laminate HPL with a thickness 17.8mm and non skid surface texture according to EN 438-6. KOMPAN HPL has high wearing strength to ensure long lifetime in all climates.

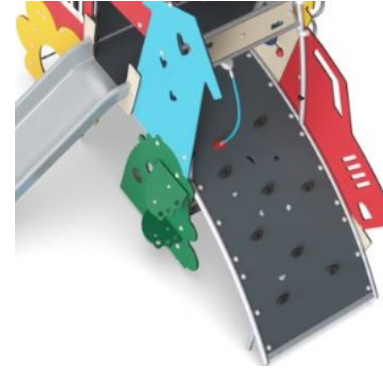

Curved climbing wall is made of Ekogrip® panel that consist of a 15mm thick PE base with 3 mm top-layer of soft rubber with a non-skid effect.

Item no. MSC641100-3717P	
Installation Information	
Max. fall height	226 cm
Safety surfacing area	58.0 m <sup>2</sup>
Total installation time	32.7
Excavation volume	1.54 m <sup>3</sup>
Concrete volume	0.00 m <sup>3</sup>
Footing depth (standard)	90 cm
Shipment weight	1,028 kg
Anchoring options	In-ground ✓ Surface ✓
Warranty Information	
EcoCore HDPE	Lifetime
Hot dip galvanised steel	Lifetime
HPL decks	15 years
Ropes & nets	10 years
Spare parts guaranteed	10 years



Molded PE slides made with 33% post-consumer materials in different colors in one-piece design with a wall thickness of minimum 5mm. The PE is tested for UV stability and has excellent impact strength and it is usable within a large temperature span.

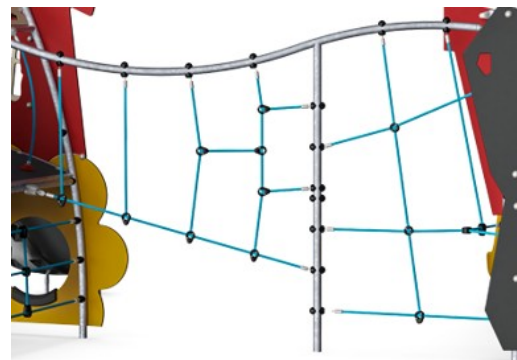

Ropes are made of UV-stabilized PP rope strands with inner steel cable reinforcement. Horizontal ropes are PUR coated to obtain good wear and tear resistance.

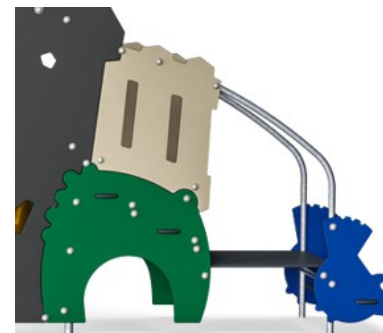

The steel surfaces are hot dip galvanised inside and outside with lead free zinc. The galvanisation has excellent corrosion resistance in outside environments and requires low maintenance.



# Sustainability Data

MSC6411

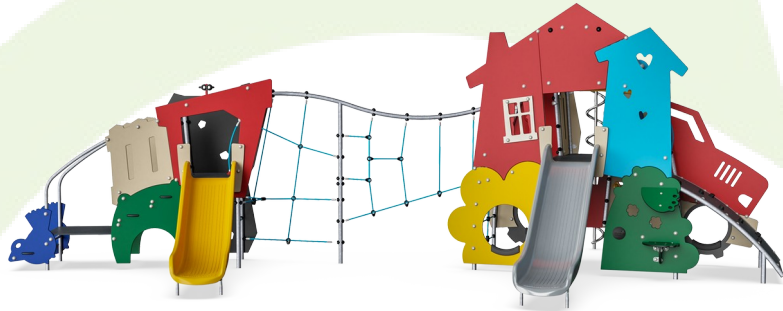

Cradle to Gate A1-A3	Total CO <sub>2</sub> emission	CO <sub>2</sub> e/kg	Recycled materials
	kg CO <sub>2</sub> e	kg CO <sub>2</sub> e/kg	%
<b>MSC641100-3717P</b>	1,922.24	2.26	53.78

The overall framework applied for these factors is the Environmental Product Declaration (EPD), which quantifies "environmental information on the life cycle of a product and enable comparisons between products fulfilling the same function" (ISO, 2006). This follows the structure and applies a Life-Cycle Assessment approach to the entire Product stage from raw material through manufacturing (A1-A3))

**Kompan A/S**  
C.F. Tietgens Boulevard 32C  
DK-5220 Odense SØ  
Denmark



## Verification of CO<sub>2</sub> calculation of: Themed play systems



Data version no. 2023-10-05

The CO<sub>2</sub> calculation and data are in compliance with the principles of a carbon footprint impact according to the GHG protocol (Greenhouse Gas Protocol), Scope 3, cradle to gate related to all individual components in the product category: "Themed play systems" represented by item no.: MSC641100-3717P.

(Scope 3 emissions include emission sources in the upstream and downstream value chain).

**Date: 30. October 2023 | Valid until: 30. October 2025**

Verified by:

Julie Marie Vejsgaard Larsen, LCA & EPD Consultant

Verification based on report: Validation of CO<sub>2</sub> calculation of 9 categories of Kompan product line, version 1.0, prepared by: Bureau Veritas HSE, Denmark: Julie M. V. Larsen.

**Publication date: 30. October 2023**

By Bureau Veritas HSE  
www.bureauveritas.dk  
+45 7731 1000



# Home & Rescue with Net Tower

MSC6411

\* Max fall height | \*\* Total height | \*\*\* Safety surfacing area

\* Max fall height | \*\* Total height

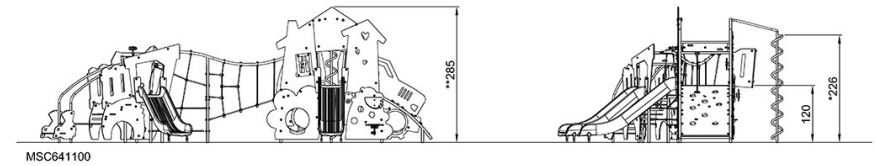
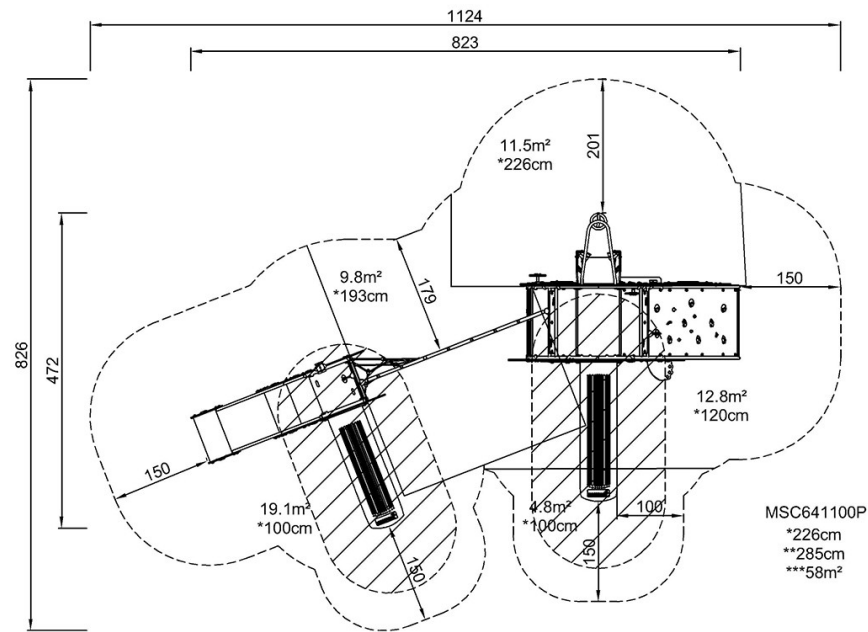

[Click to see TOP VIEW](#)

[Click to see SIDE VIEW](#)