

Dress-Up Wall with Mirror

NRO603

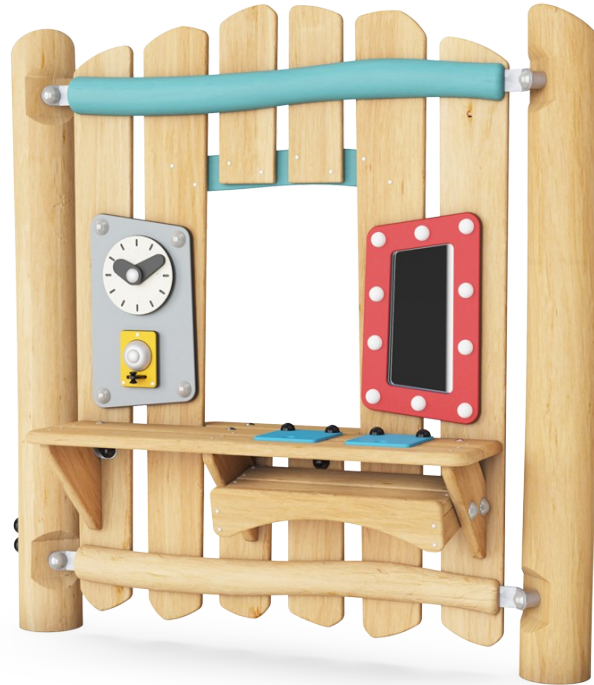

The Robinia Dress-Up wall with Mirror is a great play creator that invites numerous dramatic play scenarios: shop, make-up parlour, kitchen. It hugely attracts children in play for a long time, again and again. The table with flaps covering holes and the shelf under the table make for endless play and experimenting, shifting materials through holes.

This stimulates the child's understanding of object permanence: that things can disappear out of sight but still exist. This is fundamental for understanding that people exist even if you don't see them and thus is an important cognitive skill. The window, clock and bell invite hours of dramatic play. This is known to stimulate language development. The mirror

builds up the child's understanding of individuality and makes for hours of fun. The play panel as such encourage social interaction and cooperation in dramatic and explorative play.

Item no. NRO603-1021	
General Product Information	
Dimensions LxWxH	150x17x151 cm
Age group	1+
Play capacity (users)	6
Color options	

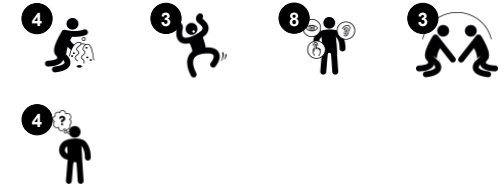

Dress-Up Wall with Mirror

NRO603



All Organic Robinia products by KOMPAN are made of Robinia wood from sustainable European sources. On request it can be supplied as FSC® Certified (FSC® C004450).



The paint used for coloured components is water based environmental friendly with excellent UV resistance. The paint is in compliance with EN 71 Part 3.



Play activities in very strong materials: HDPE-plate with HDPE-clock and hands in conveyer belt rubber, bell in pressed aluminium. Mirror in plexi-glass with a high impact resistant.

Item no. NRO603-1021

Installation Information

Max. fall height	0 cm
Safety surfacing area	12.7 m ²
Total installation time	5.5
Excavation volume	0.25 m ³
Concrete volume	0.00 m ³
Footing depth (standard)	100 cm
Shipment weight	152 kg
Anchoring options	In-ground ✓



All rubber activities/components are made of conveyer belt rubber that makes it extremely weather resistant and long lasting.

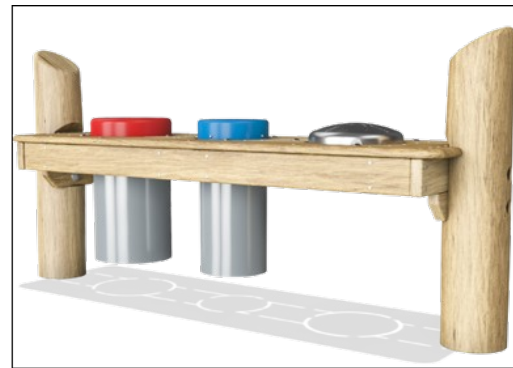

The percussion panel consist of 2 Conga Drums with PP tubes and top in coloured ABS. Babel drum in stainless steel 316L.

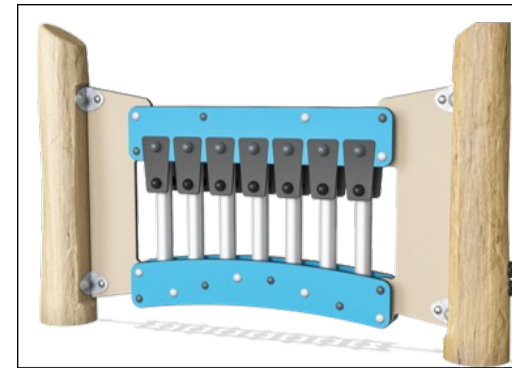

The Xylofon music panel consist of HDPE - material in 19mm EcoCore™. EcoCore™ is a highly durable, ecofriendly material. The pipes are made of die-cast aluminium specifically alloyed for outdoor environments.



Sustainability Data

NRO603

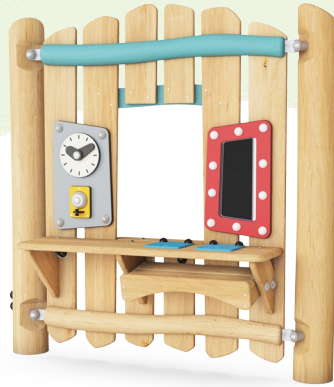

Cradle to Gate A1-A3	Total CO ₂ emission	CO ₂ e/kg	Recycled materials
	kg CO ₂ e	kg CO ₂ e/kg	%
NRO603-1021	36.50	0.30	5.20

The overall framework applied for these factors is the Environmental Product Declaration (EPD), which quantifies "environmental information on the life cycle of a product and enable comparisons between products fulfilling the same function" (ISO, 2006). This follows the structure and applies a Life-Cycle Assessment approach to the entire Product stage from raw material through manufacturing (A1-A3))

Kompan A/S
 C.F. Tietgens Boulevard 32C
 DK-5220 Odense SØ
 Denmark



Verification of CO₂ calculation of: Nature play



Data version no. 2023-10-05

The CO₂ calculation and data are in compliance with the principles of a carbon footprint impact according to the GHG protocol (Greenhouse Gas Protocol), Scope 3, cradle to gate related to all individual components in the product category: "Nature play" represented by item no.: NRO409-0621.

(Scope 3 emissions include emission sources in the upstream and downstream value chain).

Date: 30. October 2023 | Valid until: 30. October 2025

Verified by:

Julie Marie Vejsgaard Larsen, LCA & EPD Consultant

Verification based on report: Validation of CO₂ calculation of 9 categories of Kompan product line, version 1.0, prepared by: Bureau Veritas HSE, Denmark: Julie M. V. Larsen.

Publication date: 30. October 2023

By Bureau Veritas HSE
 www.bureauveritas.dk
 +45 7731 1000



Dress-Up Wall with Mirror

NRO603

* Max fall height | ** Total height | *** Safety surfacing area

* Max fall height | ** Total height

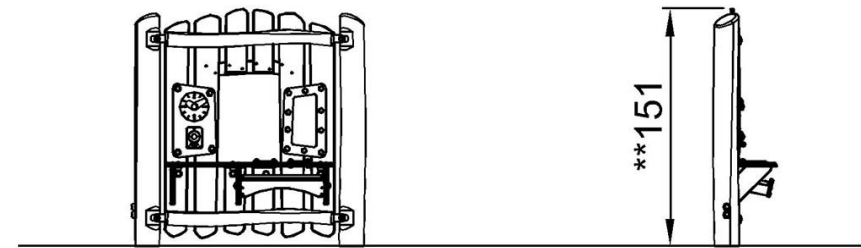
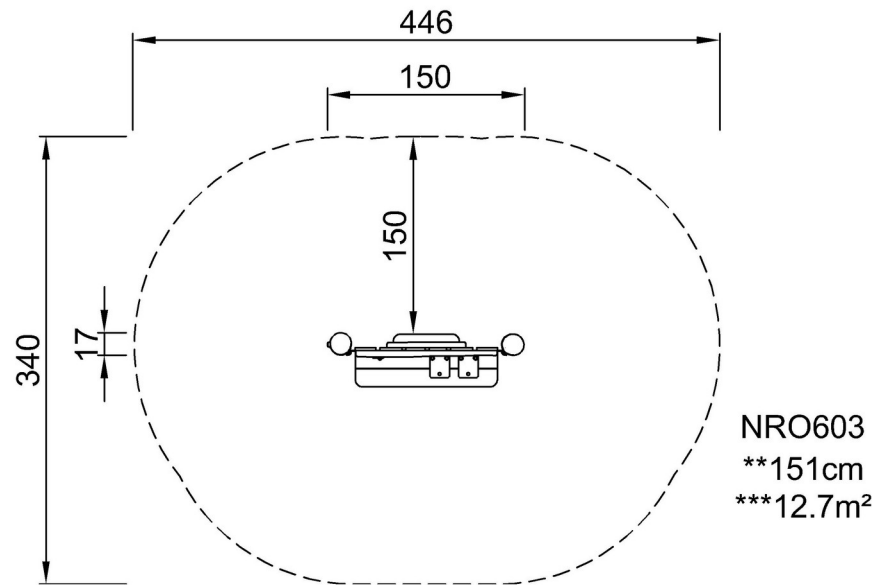

NRO603

[Click to see TOP VIEW](#)

[Click to see SIDE VIEW](#)