

# Tumbler

PCE200121

Item no. PCE200121-0602

## General Product Information

Dimensions LxWxH	560x465x324 cm
Age group	1+
Play capacity (users)	30
Color options	

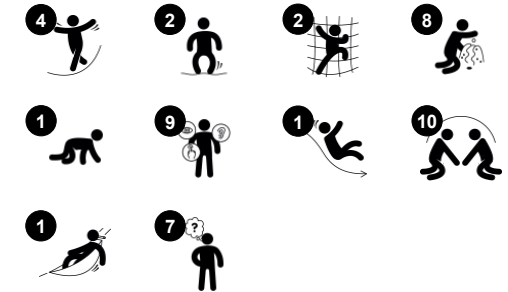

The Tumbler is a spacious, truly varied play structure which attracts young children immensely. It offers multiple potential layers of play activities to investigate. This attracts the toddlers back again and again. The bouncy activities with rubber membranes are fun, training the children's sense of balance and their ability to cooperate. The responses to

their movements additionally train cognitive skills. The many play panels can be accessed from both sides, stimulating social play and turn-taking. The transparent design and the ground level play corners and panels make the Tumbler playable from all sides. Many children can be active at the same time. The Tumbler is rich in play opportunities for toddlers, training

their cognitive, creative, social-emotional and physical development.



# Tumbler

PCE200121

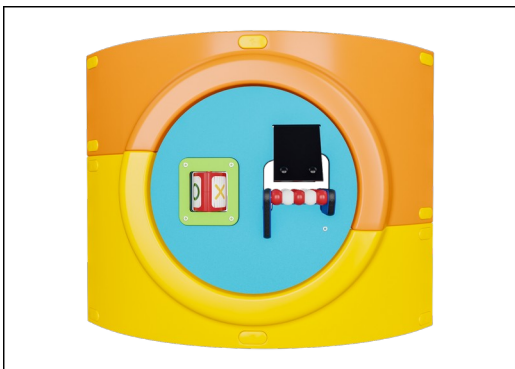

The Curved ELEMENTS panels are moulded of UV stabilised recyclable PE using 33% post-consumer recycled material. With multiple options for in-build play features that also ensures a strong panel solution. Straight panels are made of KOMPAN 19mm HDPE EcoCore™ which is a highly durable, ecofriendly and recyclable material made from +95% PCM.

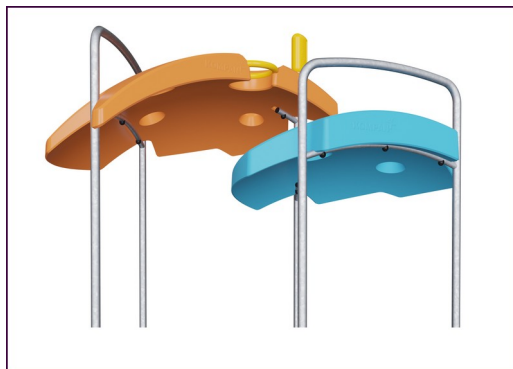

The ELEMENTS roofs are made of recyclable PE made from 33% post consumer recycled materials with a minimum wall thickness of 5 mm to ensure high durability in all climates around the world. The steel pipes are hot dip galvanised inside and outside for maximum durability.



ELEMENTS products are available in three different colour combinations: classic blue & green, blossom orange & yellow, nature lime and green.

Item no. PCE200121-0602

## Installation Information

Max. fall height	100 cm
Safety surfacing area	46.6 m <sup>2</sup>
Total installation time	27.3
Excavation volume	0.60 m <sup>3</sup>
Concrete volume	0.11 m <sup>3</sup>
Footing depth (standard)	80 cm
Shipment weight	839 kg
Anchoring options	Surface ✓ In-ground ✓



The main posts are made of high quality pregalvanized steel with powder coated top finish. Post tops are closed with caps of UV stabilized nylon (PA6). The grey colored molded decks are made of 75% post-consumer waste PP material with a non-skid pattern and texture surface. All decks are supported by unique designed low-carbon aluminum profiles with multiple attachment options.

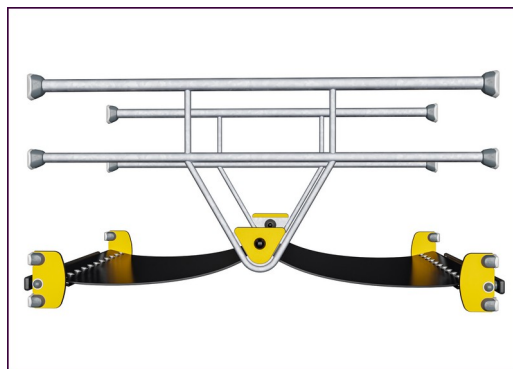

ELEMENTS rubber membranes are conveyer belt made of layers of rubber mixed of natural rubber and SBR rubber, and embedded with layers of armouring made of woven PE and PA. The thickness 8mm ensures high durability in any environment.

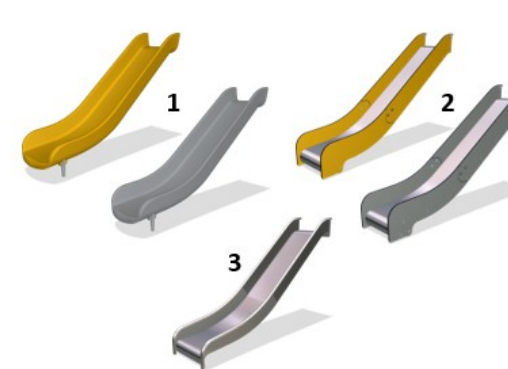

The slides are available in either molded PE made from 33% recycled post-consumer materials in different colors or in full AISI304 stainless steel with a thickness of 2mm.



# Sustainability Data

PCE200121



Cradle to Gate A1-A3	Total CO <sub>2</sub> emission	CO <sub>2</sub> e/kg	Recycled materials
	kg CO <sub>2</sub> e	kg CO <sub>2</sub> e/kg	%
<b>PCE200121-0602</b>	1,712.80	2.65	44.70

The overall framework applied for these factors is the Environmental Product Declaration (EPD), which quantifies "environmental information on the life cycle of a product and enable comparisons between products fulfilling the same function" (ISO, 2006). This follows the structure and applies a Life-Cycle Assessment approach to the entire Product stage from raw material through manufacturing (A1-A3))

**Kompan A/S**  
 C.F. Tietgens Boulevard 32C  
 DK-5220 Odense SØ  
 Denmark



## Verification of CO<sub>2</sub> calculation of: Play systems



Data version no. 2023-10-05

The CO<sub>2</sub> calculation and data are in compliance with the principles of a carbon footprint impact according to the GHG protocol (Greenhouse Gas Protocol), Scope 3, cradle to gate related to all individual components in the product category: "Play systems" represented by item no.: PCM200321-0950.

(Scope 3 emissions include emission sources in the upstream and downstream value chain).

**Date: 30. October 2023 | Valid until: 30. October 2025**

Verified by:

Julie Marie Vejsgaard Larsen, LCA & EPD Consultant

Verification based on report: Validation of CO<sub>2</sub> calculation of 9 categories of Kompan product line, version 1.0, prepared by: Bureau Veritas HSE, Denmark: Julie M. V. Larsen.

**Publication date: 30. October 2023**

By Bureau Veritas HSE  
 www.bureauveritas.dk  
 +45 7731 1000



# Tumbler

PCE200121

\* Max fall height | \*\* Total height | \*\*\* Safety surfacing area

\* Max fall height | \*\* Total height

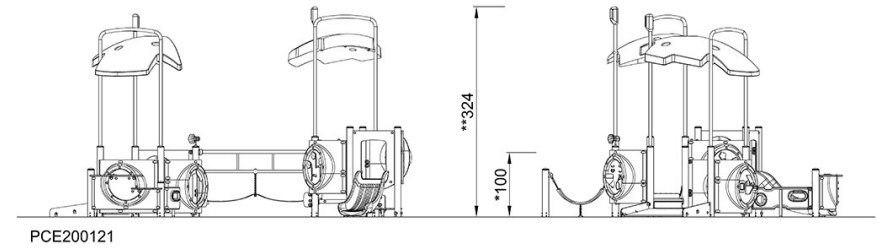
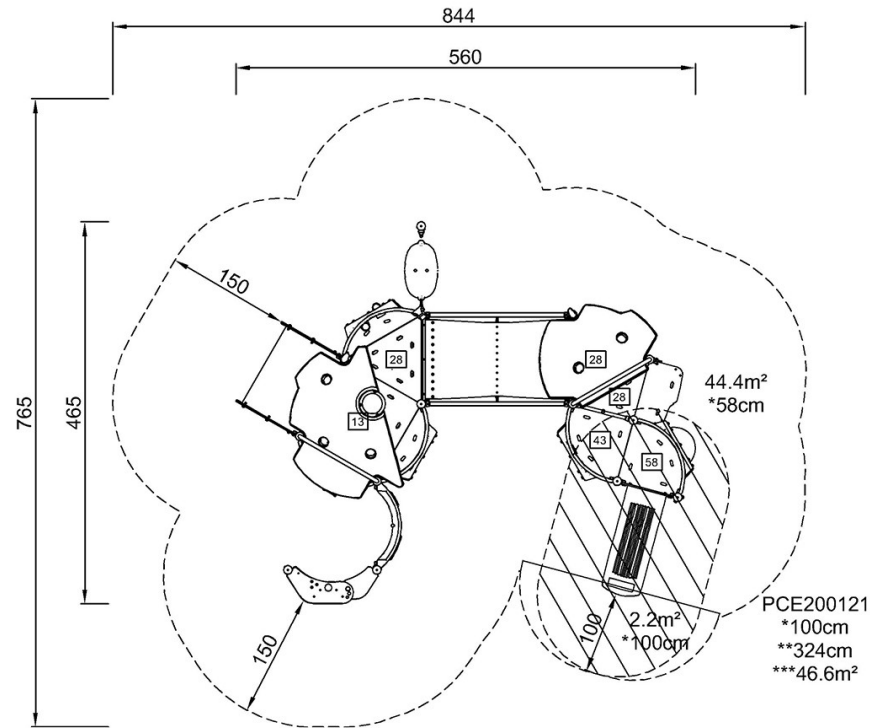

[Click to see TOP VIEW](#)

[Click to see SIDE VIEW](#)