

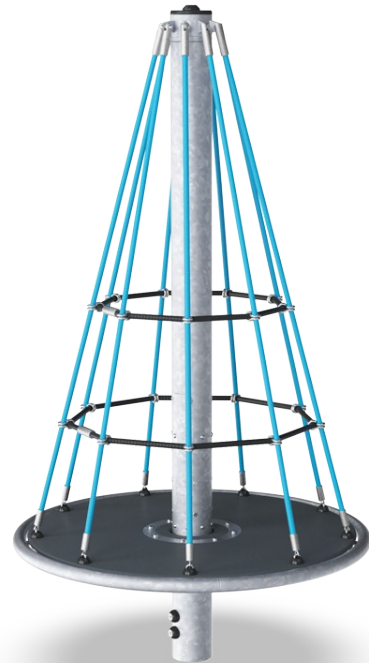

Mini Twister

COR20310



The Mini Twister's vertical rope attracts children to play, rotate and climb to the top, and the fun of rotating makes them return for more again and again. The Twister provides play for children of different ages encouraging social play across different age groups. When climbing to the top, down and around, pushing and pulling the twister and then jumping off,

children develop their motor skills, balance, muscle strength and bone density. The cooperation and negotiation of who does what to spin the twister net trains social-emotional skills such as turn-taking, tolerance and empathy. This is a playful way to train important life skills.

Item no. COR203101-1112	
General Product Information	
Dimensions LxWxH	125x125x225 cm
Age group	3+
Play capacity (users)	7
Colour options	

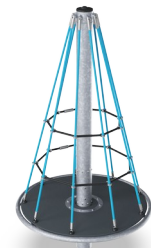

Mini Twister

COR20310



Climbing net

Physical: the net allow for climbing and crawling, supporting proprioception, cross-coordination and spatial awareness. Climbing here takes muscle strength, pushing and pulling arms to get upwards. **Social-Emotional:** the net allow more children being seated together, sharing.

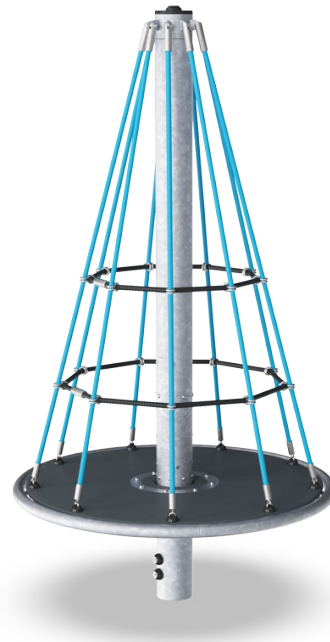

Rotation

Physical: pushing or pulling it into motion, children use their muscle strength and strengthen their cardio. The rotation develops the sense of balance and space when enjoying the ride. **Social-Emotional:** listening and negotiating how slow or fast to go, children develop their empathy and cooperation skills.



Big meshes

Physical: the big meshes allow for climbing and crawling, supporting proprioception, cross coordination and spatial awareness. Climbing here takes muscle strength, pushing and pulling arms to get upwards. **Social-Emotional:** allow more children being seated together, sharing.

Mini Twister

COR20310



Ropes of UV-stabilized PES rope strands with inner steel cable reinforcement. The polyester yarn is made from +95% post-consumer materials and is inductively melted onto each strand. The ropes are highly wear-and vandalism-resistant and can be replaced at site if needed.



Corocord 'S' clamps are used as universal connections in Corocord products. 8mm stainless steel rods with rounded edges are pressed around the ropes with a special hydraulic press, making them the ideal connector: safe, durable and vandalism-proof, all while allowing the typical movement of rope play structures.



Heavy duty engineered bearing system with single row deep groove ball bearings with rubber seals. The fully closed bearing construction is lifetime lubricated and maintenance free. The Bearing system has an integrated drag brake according to global safety standards.



All decks are supported by a unique steel construction with multiple deck supports and fixations. The HPL decks with a thickness of 17.8mm have a very high wearing strength and feature a unique KOMPAN non skid surface texture.



The steel posts are hot dip galvanised inside and outside with lead free zinc. The galvanisation has excellent corrosion resistance in outside environments and requires low maintenance.

Item no. COR203101-1112

Installation Information

Max. fall height	125 cm
Safety surfacing area	21.6 m ²
Total installation time	6.2
Excavation volume	1.10 m ³
Concrete volume	0.70 m ³
Footing depth (standard)	110 cm
Shipment weight	333 kg
Anchoring options	In-ground ✓

Warranty Information

Corocord rope	10 years
Hot dip galvanised steel	Lifetime
HPL decks	15 years
Movable parts	2 years
Spare parts guaranteed	10 years



Sustainability Data

COR20310

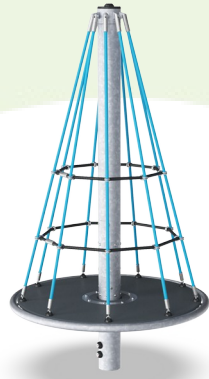

Cradle to Gate A1-A3	Total CO ₂ emission	CO ₂ e/kg	Recycled materials
	kg CO ₂ e	kg CO ₂ e/kg	%
COR203101-1112	539.68	2.69	43.73

The overall framework applied for these factors is the Environmental Product Declaration (EPD), which quantifies "environmental information on the life cycle of a product and enable comparisons between products fulfilling the same function" (ISO, 2006). This follows the structure and applies a Life-Cycle Assessment approach to the entire Product stage from raw material through manufacturing (A1-A3))

Kompan A/S
C.F. Tietgens Boulevard 32C
DK-5220 Odense SØ
Denmark



Verification of CO₂ calculation of: Corocord



Data version no. 2023-10-05

The CO₂ calculation and data are in compliance with the principles of a carbon footprint impact according to the GHG protocol (Greenhouse Gas Protocol), Scope 3, cradle to gate related to all individual components in the product category: "Corocord" represented by item no.: COR314011-1101.

(Scope 3 emissions include emission sources in the upstream and downstream value chain).

Date: 30. October 2023 | Valid until: 30. October 2025

Verified by:

Julie Marie Vejsgaard Larsen, LCA & EPD Consultant

Verification based on report: Validation of CO₂ calculation of 9 categories of Kompan product line, version 1.0, prepared by: Bureau Veritas HSE, Denmark: Julie M. V. Larsen.

Publication date: 30. October 2023

By Bureau Veritas HSE
www.bureauveritas.dk
+45 7731 1000



Mini Twister

COR20310

* Max fall height | ** Total height | *** Safety surfacing area

* Max fall height | ** Total height

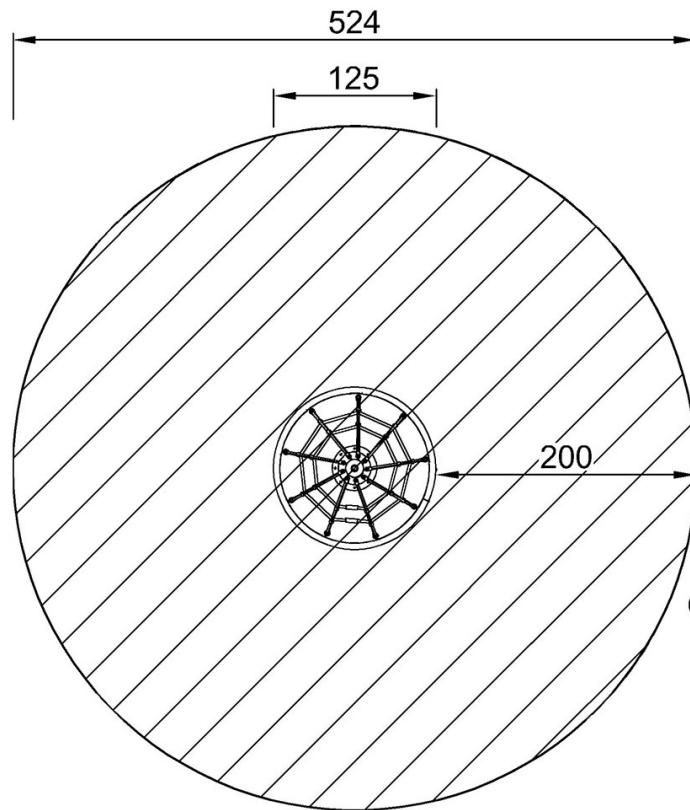

COR203101
*125cm
**225cm
***21.6m²

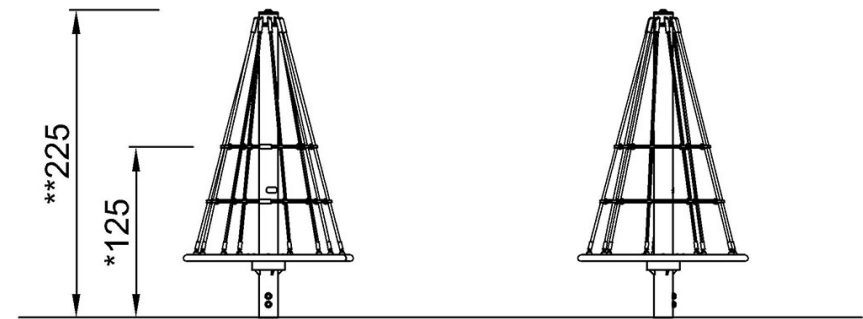

COR203101

[Click to see TOP VIEW](#)

[Click to see SIDE VIEW](#)