

Turbo Challenge

FPW212



The Turbo Challenge is the most dynamic and thrilling element of all obstacle course exercises. To do the exercise in the best way, a combination of skills, timing, rhythm and cross body coordination is needed. This Turbo Challenge is wide and high to ensure anyone can hang and move freely. To make sure that everyone can reach the dynamic wheels there

are 4 stepping pods at different heights. For an optimized and direct swing the 4 four dynamic wheels have been mounted under a 5-degree angle.

Item no. FPW21200-0900	
General Product Information	
Dimensions LxWxH	445x119x270 cm
Age group	8+
Play capacity (users)	3
Colour options	



Turbo Challenge

FPW212



Turbo challenge

Physical: upper body muscles are trained when hanging. Agility, proprioception and coordination are trained when spinning from one ring to the next. Spatial awareness and sense of balance are trained by the rotating motion. **Social-Emotional:** the sections of each of the spinners allow for more children hanging in arms or knees, cooperating. This trains empathy and turn-taking skills.



Turbo Challenge

FPW212



Post are made of Ø101.6 x 2mm, pre-galvanized carbon steel and powder coated, a great protection to all conditions.



The connectors are made of die-cast aluminium, specially alloyed for the outdoor environments and heavy usage. The screws attaching the connectors are stainless steel and protected by zinc washers.



Steps are made of extruded aluminium with a non-skid surface. Aluminium has high corrosion resistance and ensures durability of the product. Steps have been mounted at heights of 34,7cm and 54,7cm this creates an easy access to reach the overhead activity

Item no. FPW21200-0900

Installation Information

Max. fall height	233 cm
Safety surfacing area	33.1 m ²
Total installation time	5.2
Excavation volume	0.38 m ³
Concrete volume	0.20 m ³
Footing depth (standard)	90 cm
Shipment weight	300 kg
Anchoring options	In-ground ✓ Surface ✓

Warranty Information

Bearing construction	5 years
Hot dip galvanised steel	Lifetime
Post	10 years
Spare parts guaranteed	10 years
Wheels	10 years



Sustainability Data

FPW212

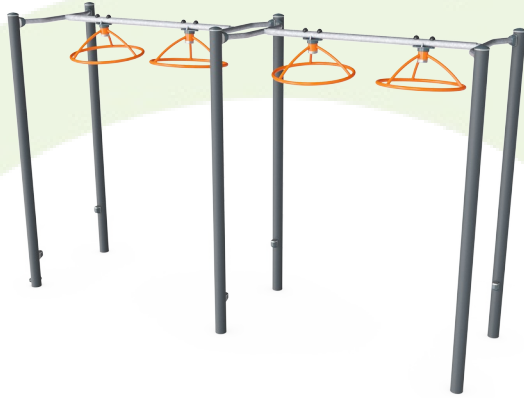

Cradle to Gate A1-A3	Total CO ₂ emission	CO ₂ e/kg	Recycled materials
	kg CO ₂ e	kg CO ₂ e/kg	%
FPW21200-0900	625.21	3.30	48.61

The overall framework applied for these factors is the Environmental Product Declaration (EPD), which quantifies "environmental information on the life cycle of a product and enable comparisons between products fulfilling the same function" (ISO, 2006). This follows the structure and applies a Life-Cycle Assessment approach to the entire Product stage from raw material through manufacturing (A1-A3))

Kompan A/S
 C.F. Tietgens Boulevard 32C
 DK-5220 Odense SØ
 Denmark



Verification of CO₂ calculation of: Fitness



Data version no. 2023-10-05

The CO₂ calculation and data are in compliance with the principles of a carbon footprint impact according to the GHG protocol (Greenhouse Gas Protocol), Scope 3, cradle to gate related to all individual components in the product category: "Fitness" represented by item no.: FAZ10100-0900.

(Scope 3 emissions include emission sources in the upstream and downstream value chain).

Date: 30. October 2023 | Valid until: 30. October 2025

Verified by:

Julie Marie Vejsgaard Larsen, LCA & EPD Consultant

Verification based on report: Validation of CO₂ calculation of 9 categories of Kompan product line, version 1.0, prepared by: Bureau Veritas HSE, Denmark: Julie M. V. Larsen.

Publication date: 30. October 2023

By Bureau Veritas HSE
 www.bureauveritas.dk
 +45 7731 1000



Turbo Challenge

FPW212

* Max fall height | ** Total height | *** Safety surfacing area

* Max fall height | ** Total height

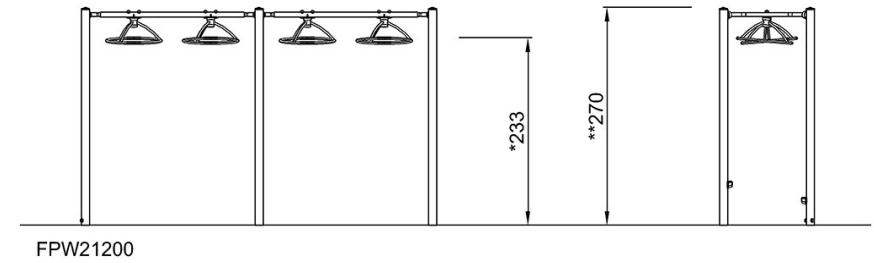
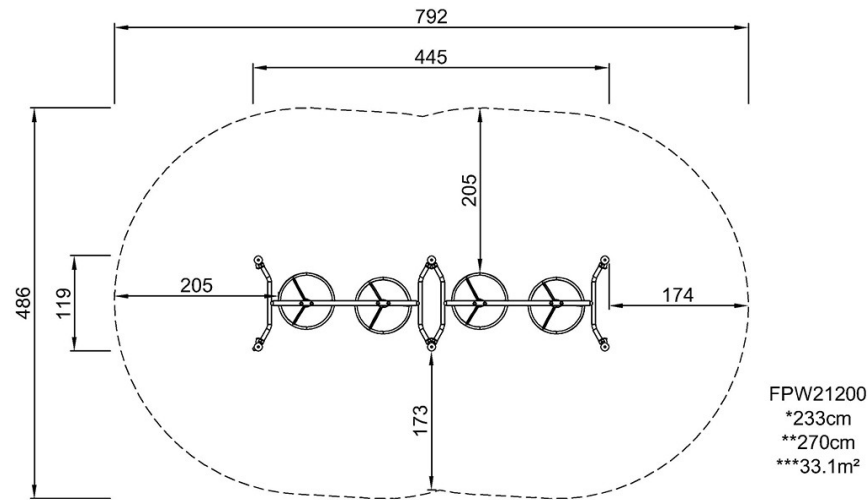

[Click to see TOP VIEW](#)

[Click to see SIDE VIEW](#)