

Sway Alley

PCM80921

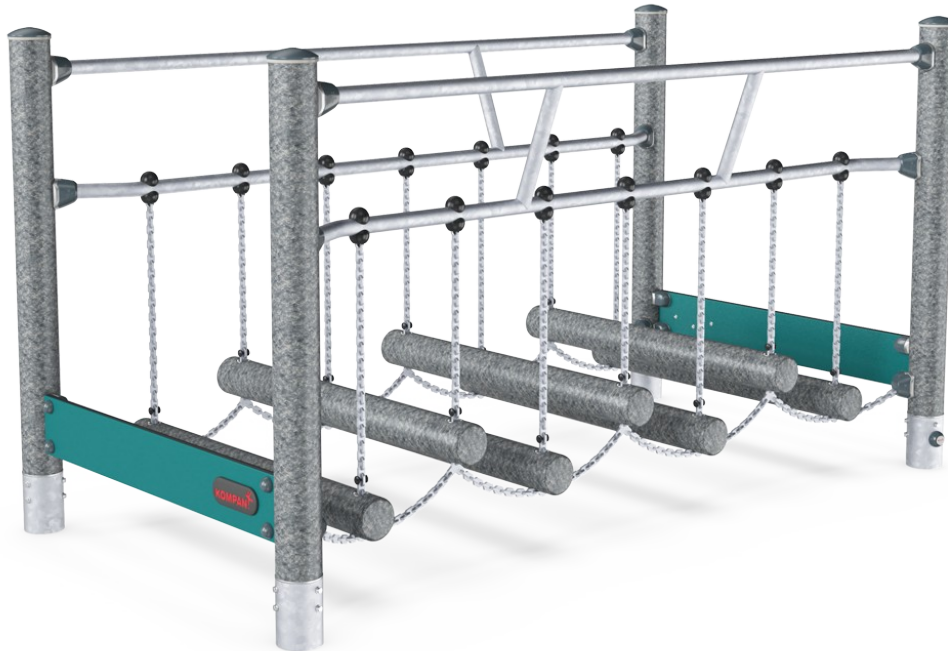

Item no. PCM80921-0950

General Product Information

Dimensions LxWxH	121x229x125 cm
Age group	6+
Play capacity (users)	2
Color options	



The Sway Alley hugely attracts children to try out their balancing skills. It will be a playground success, again and again, thanks to the responsive horizontal logs. For every step the child takes, it trains important physical skills: use of the sense of balance, tensioning muscles in the feet, legs, core and arms to adjust equilibrium. For less trained bridge-

walkers, the side beams add a welcomed support. Walking the Wobble bridge is a highly social experience also. Children feel the movements of all the other children on the bridge thanks to the interconnected horizontal and vertical carrier chains. This feature adds to the physical challenge of keeping the balance when passing the bridge. It additionally spurs

cooperation, negotiation, turn-taking and consideration. These are important socio-emotional life skills, when making friends.

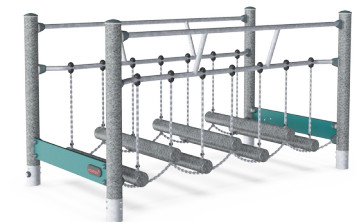

Sway Alley

PCM80921



Sway alley

Physical: passing the swaying bridge steps develops the sense of balance, which is fundamental in navigating the world securely.

Social-Emotional: passing others on the way supports consideration and turn-taking skills.



Sway Alley

PCM80921



Main posts with hot dip galvanized steel footing are available in different materials: Pressure impregnated pine wood posts. Pre-galvanized inside and outside with powder coated top finish steel posts. Lead free aluminum with color anodized top finish. Greenline TexMade posts of 95% post-consumer recycled PE and textile waste.



Panels of 19mm EcoCore™. EcoCore™ is a highly durable, eco friendly material, which is not only recyclable after use, but also consists of material produced from +95% recycled post consumer material from food packing waste.



The steel surfaces are hot dip galvanized inside and outside with lead free zinc. The galvanisation has excellent corrosion resistance in outside environments and requires low maintenance.

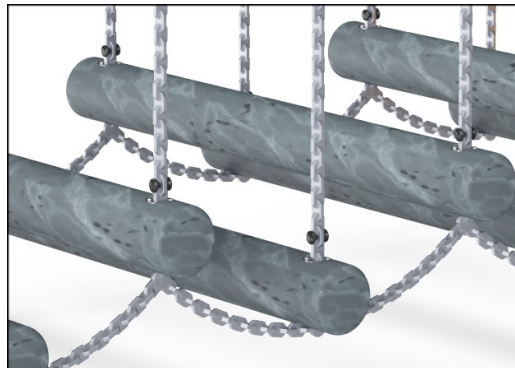

TexMade posts as stepping bars of +95% post-consumer recycled PE and textile waste.

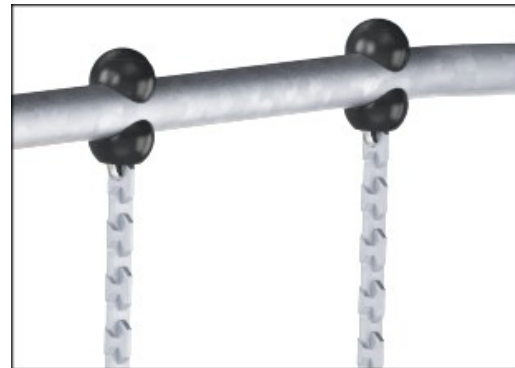

Chains are made of high-quality stainless-steel to ensure durability of the product.

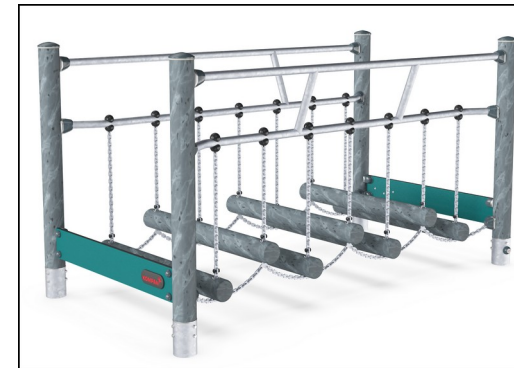

KOMPAN GreenLine versions are designed with ultimate environmentally friendly materials with lowest possible CO2e emission factor. TexMade post, EcoCore™ panels of 95% post-consumer recycled waste and molded PP decks.

Item no. PCM80921-0950

Installation Information

Max. fall height	38 cm
Safety surfacing area	19.8 m ²
Total installation time	7.6
Excavation volume	0.71 m ³
Concrete volume	0.38 m ³
Footing depth (standard)	90 cm
Shipment weight	220 kg
Anchoring options	Surface ✓ In-ground ✓

Warranty Information

Chains	10 years
EcoCore HDPE	Lifetime
Hot dip galvanized steel	Lifetime
Post	10 years
Spare parts guaranteed	10 years



Sustainability Data

PCM80921

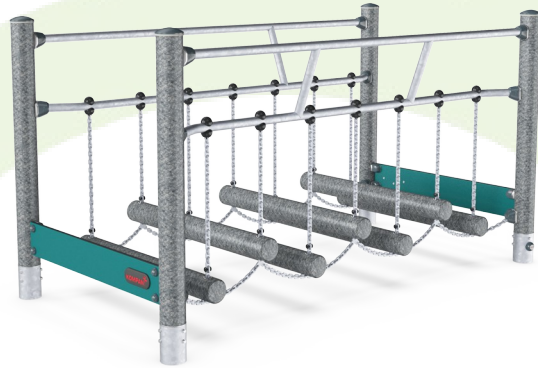

Cradle to Gate A1-A3	Total CO ₂ emission	CO ₂ e/kg	Recycled materials
	kg CO ₂ e	kg CO ₂ e/kg	%
PCM80921-0950	201.42	1.31	77.74
PCM80921-0901	229.20	1.64	72.16

The overall framework applied for these factors is the Environmental Product Declaration (EPD), which quantifies "environmental information on the life cycle of a product and enable comparisons between products fulfilling the same function" (ISO, 2006). This follows the structure and applies a Life-Cycle Assessment approach to the entire Product stage from raw material through manufacturing (A1-A3))

Kompan A/S
 C.F. Tietgens Boulevard 32C
 DK-5220 Odense SØ
 Denmark



Verification of CO₂ calculation of: Freestanding play equipment

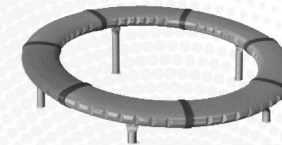

Data version no. 2023-10-05

The CO₂ calculation and data are in compliance with the principles of a carbon footprint impact according to the GHG protocol (Greenhouse Gas Protocol), Scope 3, cradle to gate related to all individual components in the product category: "Freestanding play equipment" represented by item no.: GXY916012-3417.

(Scope 3 emissions include emission sources in the upstream and downstream value chain).

Date: 30. October 2023 | Valid until: 30. October 2025

Verified by:

Julie Marie Vejsgaard Larsen, LCA & EPD Consultant

Verification based on report: Validation of CO₂ calculation of 9 categories of Kompan product line, version 1.0, prepared by: Bureau Veritas HSE, Denmark: Julie M. V. Larsen.

Publication date: 30. October 2023

By Bureau Veritas HSE
 www.bureauveritas.dk
 +45 7731 1000



Sway Alley

PCM80921

* Max fall height | ** Total height | *** Safety surfacing area

* Max fall height | ** Total height

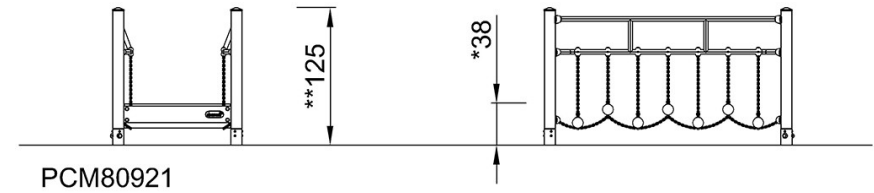
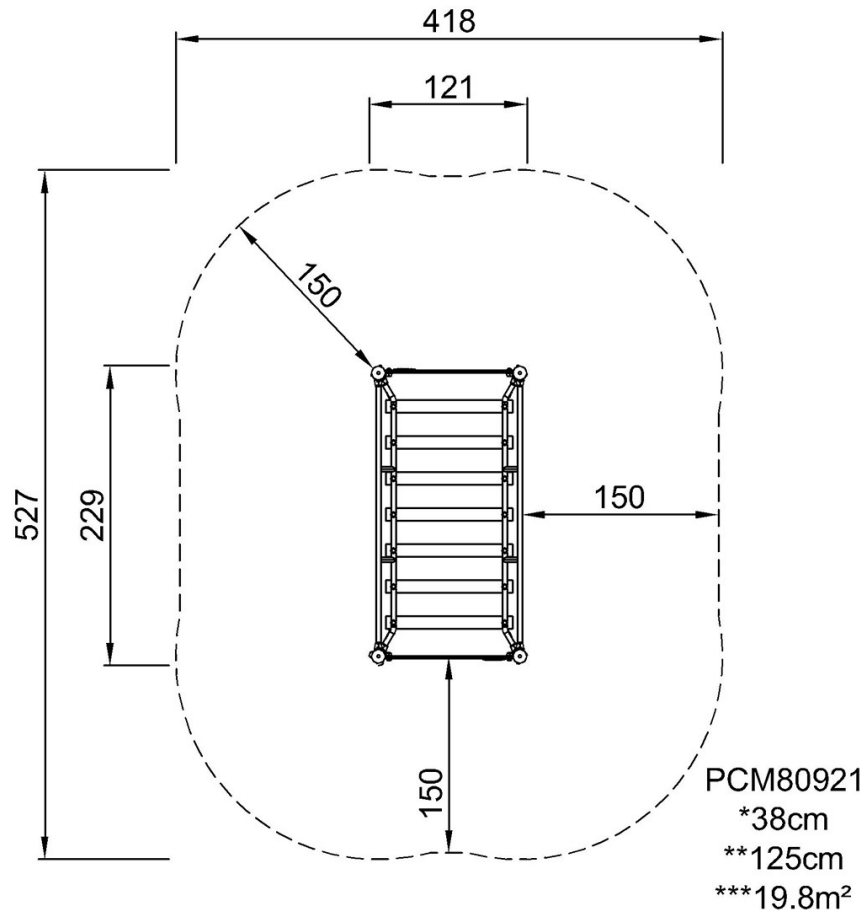

[Click to see TOP VIEW](#)

[Click to see SIDE VIEW](#)