

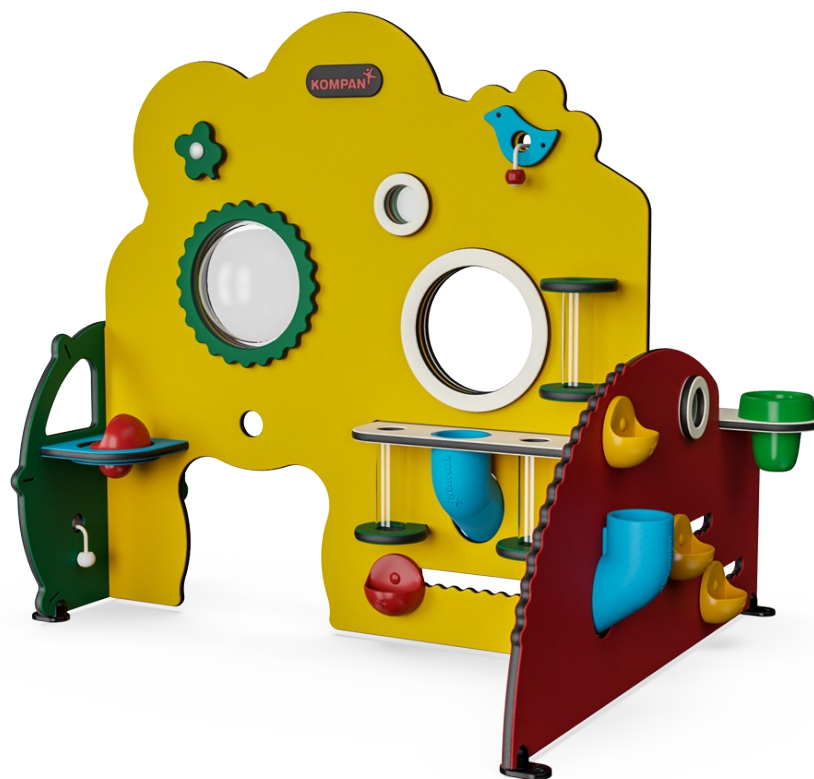

# Green House & Florist

MSV604



Item no. MSV60400-0201	
General Product Information	
Dimensions LxWxH	146x120x121 cm
Age group	6m+
Play capacity (users)	8
Colour options	

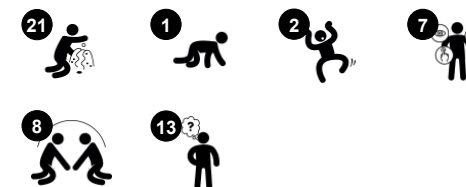

Wow! Children are immensely attracted to the activity of the Green House & Florist. In a small space, children play intensely, again and again. Loaded with play, the play unit benefits the children's physical, social-emotional, cognitive and creative development. Numerous play features encourage social play as they unite children with tangible, cross-panel play

activities: the tube, sand scoop and string with knob. The Green House & Florist has tangible themes: switch, bell, scoops making sounds when run in the toothed grooves, see-through flower vases. These scaffold logical thinking skills as children push, pull and investigate the numerous play items stimulate the child's logical thinking skills. The rich themes in-spire

dramatic play, which is phenomenal for language development: a main factor for learning, friendships and life success.



# Green House & Florist

MSV604



## Funnel

**Social-Emotional:** trains cooperation and turn-taking as children put materials into the funnel. **Cognitive:** the passing of materials through funnels supports the children's logical thinking and for younger children the understanding of object permanence: that materials don't vanish but run through at the other end.

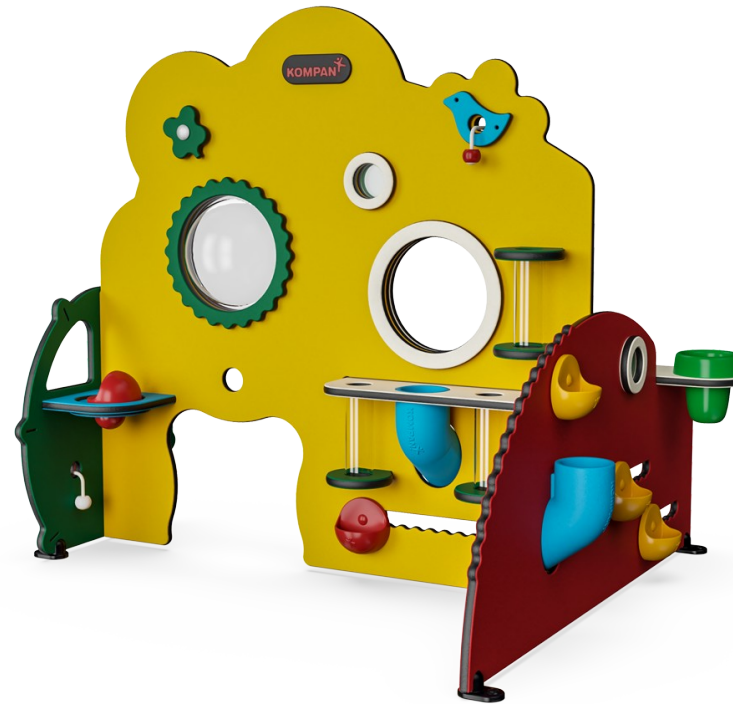

## See-through tubes

**Social-Emotional:** the paired tubes invite parallel and cooperative play. **Cognitive:** construction play and the understanding of object permanence are supported when shifting items through the see-through tubes.

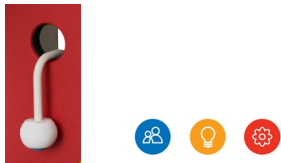

## String with knobs

**Social-Emotional:** turn-taking and cooperation are supported when pulling the string from side to side with friends or caregiver. **Cognitive:** an understanding of object permanence is supported when the knob disappears and reappears when pulled. **Creative:** leaving the knob in different positions can support symbolic and creative thinking.

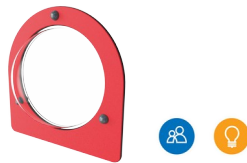

## Bubble Window

**Social-Emotional:** invites interaction between outside and inside. **Cognitive:** distorts the sound of the voice, developing logical thinking.

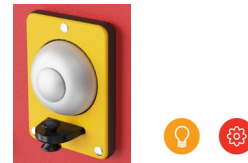

## Bell

**Cognitive:** understanding cause and effect when ringing bell. **Creative:** leaving a mark in creating a sound rhythm when ringing or knocking the bell.



## Pot

**Cognitive:** the pot can be removed, stimulating cause and effect understanding. Filling and emptying the pot stimulates logical thinking and the understanding of concepts such as empty and full. **Creative:** placing the pot in other areas of the play space in creative ways can support symbolic and creative thinking.



## Sand scoops

**Physical:** hand eye coordination and push-pull movements. **Social-Emotional:** invites cooperation due to the two-sidedness and provides for parallel play. **Cognitive:** logical thinking: cause and effect understanding when running scoops in grooves or shifting materials from scoop to scoop. **Creative:** shifting scoops, creating new scoop positions.

# Green House & Florist

MSV604



Panels of 19mm EcoCore™. EcoCore™ is a highly durable, eco friendly material, which is not only recyclable after use, but also consists of material produced from +95% recycled post consumer material from food packing waste.



Sand Pipe is made with 33% post-consumer materials in different colors in one-piece design with a wall thickness of minimum 5mm. Material in accordance with the European Standard EN 71-3 and tested for UV stability.



Pots are made of pressure moulded high quality nylon (PA6). PA6 has good wearing and impact strength.

Item no. MSV60400-0201

### Installation Information

Max. fall height	0 cm
Safety surfacing area	14.9 m <sup>2</sup>
Total installation time	5.1
Excavation volume	0.00 m <sup>3</sup>
Concrete volume	0.00 m <sup>3</sup>
Footing depth (standard)	0 cm
Shipment weight	52 kg
Anchoring options	Surface ✓

### Warranty Information

EcoCore HDPE	Lifetime
Membrane	2 years
Movable parts	2 years
PUR components	10 years
Spare parts guaranteed	10 years



On the side of the wall there is a transparent bubble made from UV-stabilised PC.



See-through tubes are made of PPMA. PPMA has outstanding durability and resistance to UV radiation.



# Sustainability Data

MSV604

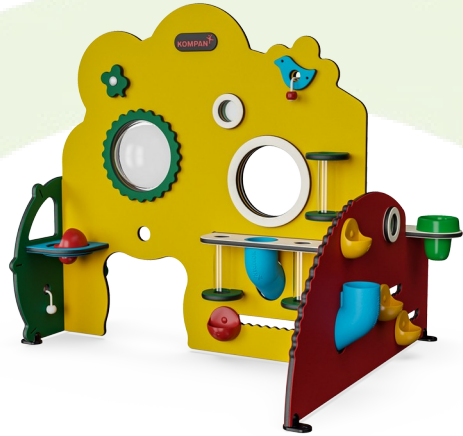

Cradle to Gate A1-A3	Total CO <sub>2</sub> emission	CO <sub>2</sub> e/kg	Recycled materials
	kg CO <sub>2</sub> e	kg CO <sub>2</sub> e/kg	%
<b>MSV60400-0201</b>	64.14	1.31	85.07

The overall framework applied for these factors is the Environmental Product Declaration (EPD), which quantifies "environmental information on the life cycle of a product and enable comparisons between products fulfilling the same function" (ISO, 2006). This follows the structure and applies a Life-Cycle Assessment approach to the entire Product stage from raw material through manufacturing (A1-A3))

**Kompan A/S**  
 C.F. Tietgens Boulevard 32C  
 DK-5220 Odense SØ  
 Denmark



## Verification of CO<sub>2</sub> calculation of: Themed play systems



Data version no. 2023-10-05

The CO<sub>2</sub> calculation and data are in compliance with the principles of a carbon footprint impact according to the GHG protocol (Greenhouse Gas Protocol), Scope 3, cradle to gate related to all individual components in the product category: "Themed play systems" represented by item no.: MSC641100-3717P.

(Scope 3 emissions include emission sources in the upstream and downstream value chain).

**Date: 30. October 2023 | Valid until: 30. October 2025**

Verified by:

Julie Marie Vejsgaard Larsen, LCA & EPD Consultant

Verification based on report: Validation of CO<sub>2</sub> calculation of 9 categories of Kompan product line, version 1.0, prepared by: Bureau Veritas HSE, Denmark: Julie M. V. Larsen.

**Publication date: 30. October 2023**

By Bureau Veritas HSE  
 www.bureauveritas.dk  
 +45 7731 1000



# Green House & Florist

MSV604

\* Max fall height | \*\* Total height | \*\*\* Safety surfacing area

\* Max fall height | \*\* Total height

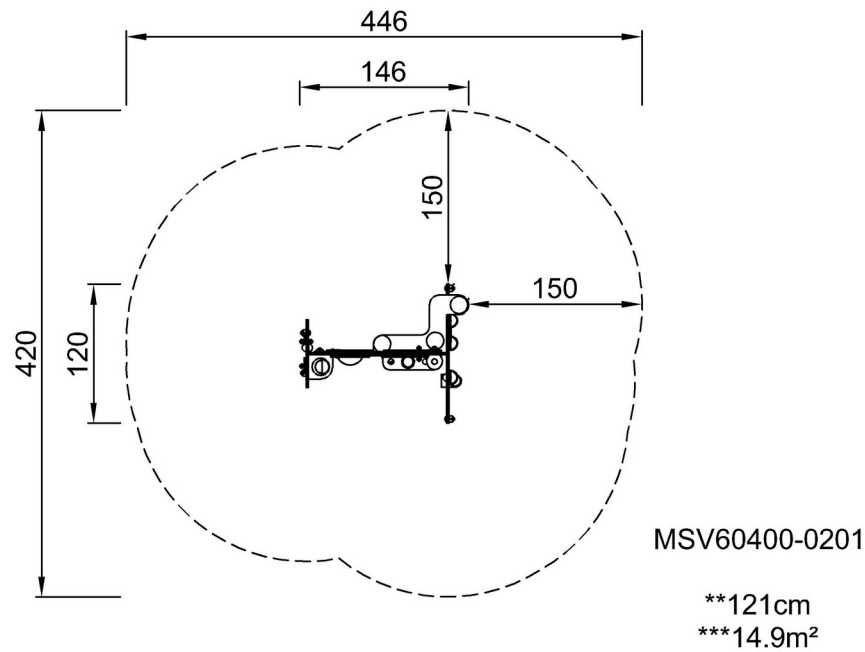

MSV60400-0201

[Click to see TOP VIEW](#)

[Click to see SIDE VIEW](#)