

Motivator with Shading

PCE105823

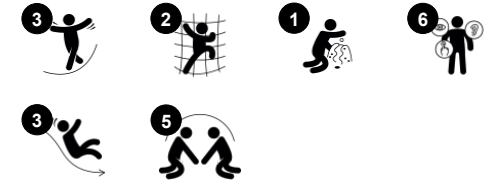

Item no. PCE105823-0903	
General Product Information	
Dimensions LxWxH	418x435x420 cm
Age group	2+
Play capacity (users)	12
Colour options	



The Motivator is a fantastic, slick play unit that will motivate social and physical play again and again. The varied activities support children's play and encourage richer play times. Children can climb and slide, along with friends, which supports social relationships and emotional compassion. After climbing up either of the steps, using cross-coordination and strength to

get to the platform, the varied slides offer rewarding ways to return to the ground, alone or with a friend. Sliding apart from training the sense of balance and the core muscles also make children continue to play. Children will find the Motivator great for meeting for play, with all the play variation. The Megaphone adds a social dimension when used to calling

friends to the Motivator for more play. The rich play variety in little space motivates play hugely.



Motivator with Shading

PCE105823



Pipe ladder

Physical: cross coordination and eye-hand coordination are supported when children climb the ladder. The climbing also supports leg and arm muscles. **Social-Emotional:** learning about turn taking and cooperation.



Megaphone

Social-Emotional: inspires communication and turn-taking skills. **Cognitive:** distortion of sound evokes curiosity and stimulates an understanding of cause and effect.



Double slide

Physical: sliding develops spatial awareness and a sense of balance. Furthermore, the core muscles are trained when sitting upright going down. **Social-Emotional:** invites socializing, supports parent-child and peer-to-peer play. **Cognitive:** young children train their understanding of space, speed and distances when sliding down quickly.

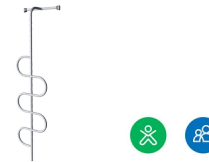

Climbing pole

Physical: cross coordination and muscle strength are trained. **Social-Emotional:** turn-taking and cooperation.

Motivator with Shading

PCE105823

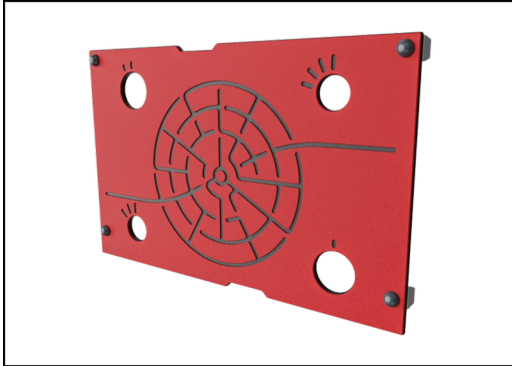

Panels of 19mm EcoCore™. EcoCore™ is a highly durable, eco friendly material, which is not only recyclable after use, but also consists of material produced from +95% recycled post consumer material from food packing waste.



The ELEMENTS roofs are made of recyclable PE made from 33% post consumer recycled materials with a minimum wall thickness of 5 mm to ensure high durability in all climates around the world. The steel pipes are hot dip galvanised inside and outside for maximum durability.



Sails of commercial 95 high density PE knitted specially for sun-shade structures. The sails are treated with UV stabilizers to ensure a long life-time. The sails are supported by a hot dip galvanised steel frame and tightened by stainless steel devices.

Item no. PCE105823-0903

Installation Information

Max. fall height	118 cm
Safety surfacing area	32.0 m ²
Total installation time	16.2
Excavation volume	0.41 m ³
Concrete volume	0.05 m ³
Footing depth (standard)	90 cm
Shipment weight	520 kg
Anchoring options	In-ground ✓ Surface ✓

Warranty Information

EcoCore HDPE	Lifetime
Post	10 years
PP Decks	10 years
Spare parts guaranteed	10 years
Sun shading sails	2 years



The main posts are made of high quality pregalvanized steel with powder coated top finish. Post tops are closed with caps of UV stabilized nylon (PA6). The grey colored molded decks are made of 75% post-consumer waste PP material with a non-skid pattern and texture surface. All decks are supported by unique designed low-carbon aluminum profiles with multiple attachment options.

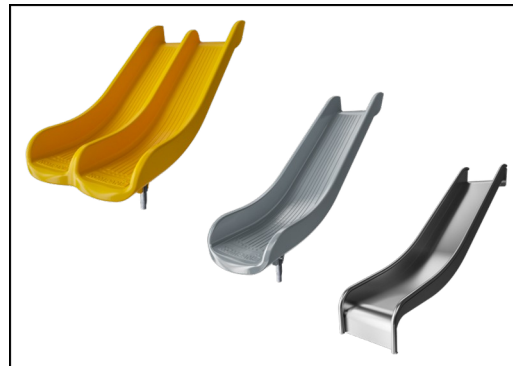

The slides are available in either molded PE made from 33% recycled post-consumer materials in different colors or in full AISI304 stainless steel with a thickness of 2mm.

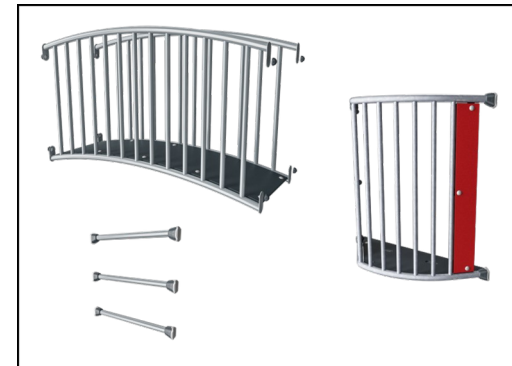

The steel surfaces are hot dip galvanised inside and outside with lead free zinc. The galvanisation has excellent corrosion resistance in outside environments and requires low maintenance.



Sustainability Data

PCE105823



Cradle to Gate A1-A3	Total CO ₂ emission	CO ₂ e/kg	Recycled materials
	kg CO ₂ e	kg CO ₂ e/kg	%
PCE105823-0903	828.09	2.11	55.58

The overall framework applied for these factors is the Environmental Product Declaration (EPD), which quantifies "environmental information on the life cycle of a product and enable comparisons between products fulfilling the same function" (ISO, 2006). This follows the structure and applies a Life-Cycle Assessment approach to the entire Product stage from raw material through manufacturing (A1-A3))

Kompan A/S
 C.F. Tietgens Boulevard 32C
 DK-5220 Odense SØ
 Denmark



Verification of CO₂ calculation of: Play systems



Data version no. 2023-10-05

The CO₂ calculation and data are in compliance with the principles of a carbon footprint impact according to the GHG protocol (Greenhouse Gas Protocol), Scope 3, cradle to gate related to all individual components in the product category: "Play systems" represented by item no.: PCM200321-0950.

(Scope 3 emissions include emission sources in the upstream and downstream value chain).

Date: 30. October 2023 | Valid until: 30. October 2025

Verified by:

Julie Marie Vejsgaard Larsen, LCA & EPD Consultant

Verification based on report: Validation of CO₂ calculation of 9 categories of Kompan product line, version 1.0, prepared by: Bureau Veritas HSE, Denmark: Julie M. V. Larsen.

Publication date: 30. October 2023

By Bureau Veritas HSE
 www.bureauveritas.dk
 +45 7731 1000



Motivator with Shading

PCE105823

* Max fall height | ** Total height | *** Safety surfacing area

* Max fall height | ** Total height

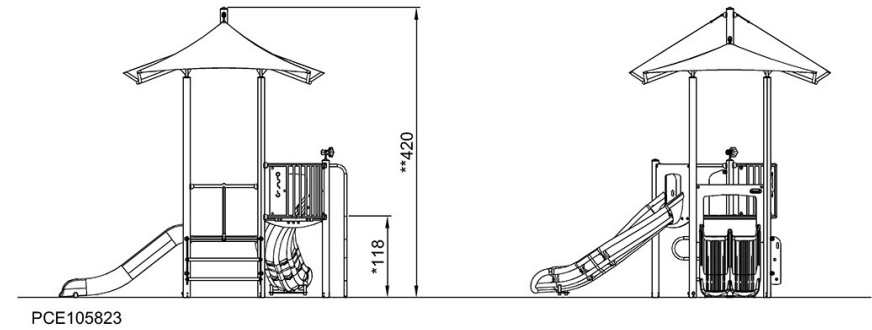
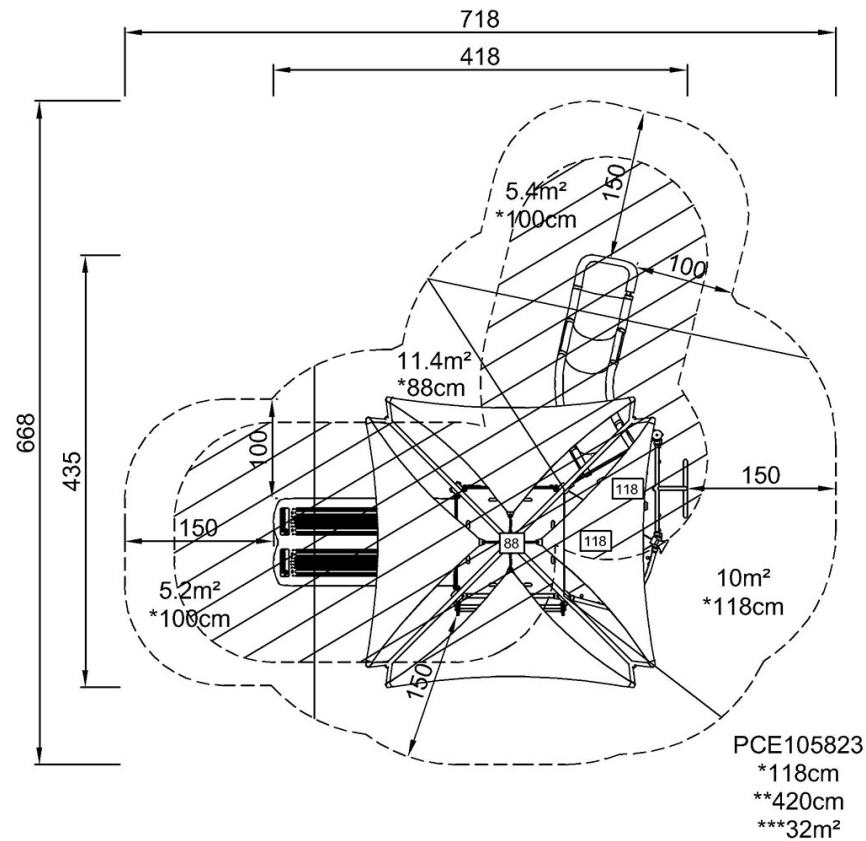

[Click to see TOP VIEW](#)

[Click to see SIDE VIEW](#)