

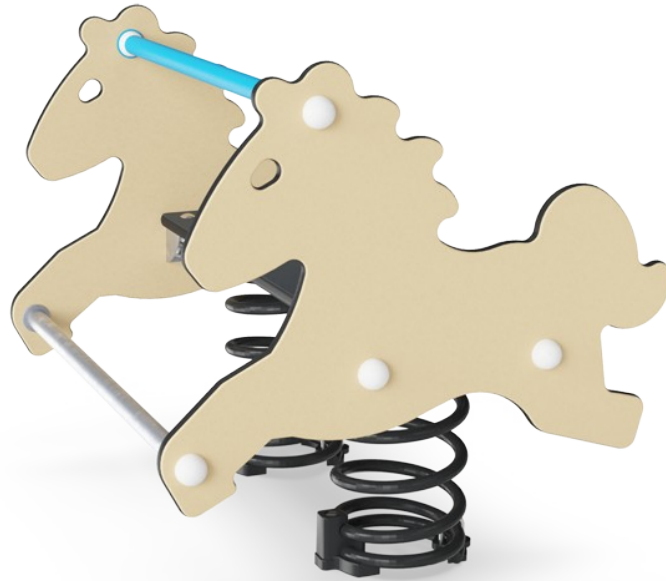

Horse, Double

PCM106



Item no. PCM106-0401

General Product Information

Dimensions LxWxH	2'6"x2'4"x2'4"
Age group	2 - 5
Play capacity (users)	2
Color options	



Rocking on the Double Horse is a wildly attractive playground activity that children will return to again and again. Children are able to control the play by moving their bodies to make the horse rock. They will feel delighted to have the horse respond to their movements. The two sides support the seated position, and the foot and handholds provide a stable point to place

feet and hands on to create the movement. There is plenty of room for two. This supports cooperation and positive social interactions. Rocking on the Double Horse is also good for physical and cognitive development. When children begin to learn the connections between their bodies and their movements, they begin to make cognitive connections to a

range of body movements and sensations. The horse theme will spur dramatic play, stimulating language development.

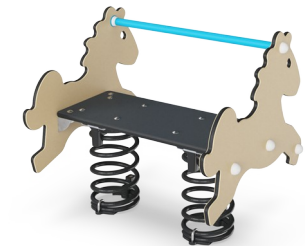

Horse, Double

PCM106



Handhold

Physical: the vertical handgrips ensure a firm grip at different heights, necessary for rocking intensely. This trains hand and arm muscles.

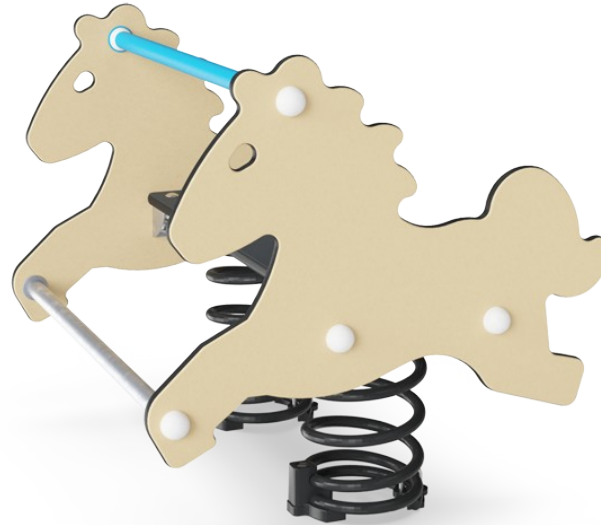

Theme

Cognitive: suggests a theme and supports dramatic play, which stimulates language and communication skills.



Foot support

Physical: the possibility of footrest supports intense rocking. Rocking stimulates the senses of balance and space that are fundamental in managing the world securely.



Rocking spring

Physical: response to movement increases spatial awareness and sense of balance. These are fundamental motor skills that help the child's ability to sit still on a chair which takes a good sense of balance. **Cognitive:** trains the understanding of cause and effect: when I move my body, the spring responds with movement.



Double seating option

Social-Emotional: the possibility of rocking together supports cooperation skills. Furthermore, the physical contact with others is great for the well-being of children, measurable in lower cortisol (stress hormone) levels.

Horse, Double

PCM106



Panels of 19mm EcoCore™. EcoCore™ is a highly durable, eco friendly material, which is not only recyclable after use, but also consists of a core produced from 100% recycled material.



KOMPAN Springs are made of high quality spring steel according to EN10270. The springs are cleaned by phosphating before they are painted with an epoxy primer and a polyester powder coating as top finish. The springs are fixed by unique anti pinch fittings for maximum safety and long lifetime.

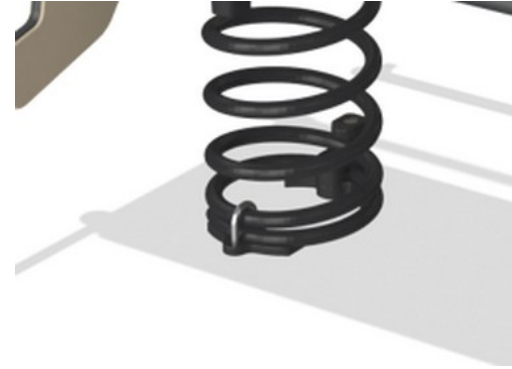

The springs are fixed by unique anti pinch fittings for maximum safety and long lifetime.

Item no. PCM106-0401	
Installation Information	
Max. fall height	1'4"
Safety surfacing area	191ft ²
Total installation time	2.8
Excavation volume	0.35yd ³
Concrete volume	0yd ³
Footing depth (standard)	1'5"
Shipment weight	120lbs
Anchoring options	In-ground ✓ Surface ✓
Warranty Information	
EcoCore HDPE	Lifetime
Spare Parts Availability	10 Years
Springs	5 Years



Handle is made of polypropylene PP with excellent impact strength and usable within a large temperature span.

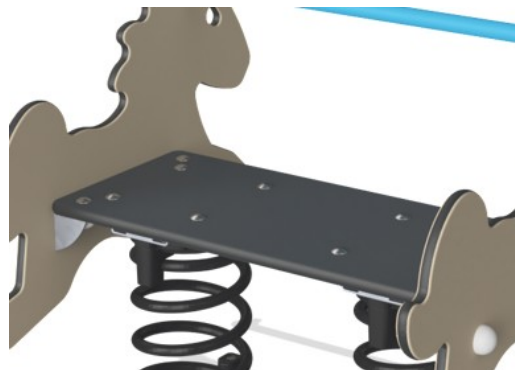

Seat is made of HPL with a thickness of 17.8mm with a very high wearing strength and a unique KOMPAN nonskid surface texture.

Elevated activities 0	Accessible elevated activities	Accessible ground level activities	Accessible ground level play types
Present	0	1	1
Required	0	1	1



Sustainability Data

PCM106

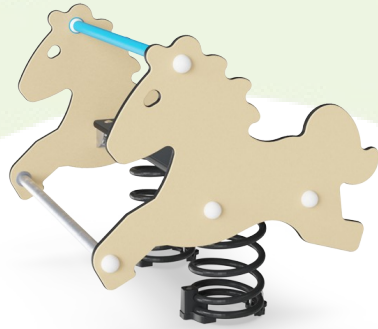

Cradle to Gate A1-A3	Total CO ₂ emission	CO ₂ e/kg	Recycled materials
	kg CO ₂ e	kg CO ₂ e/kg	%
PCM106-0401	123.30	2.20	44.18

The overall framework applied for these factors is the Environmental Product Declaration (EPD), which quantifies "environmental information on the life cycle of a product and enable comparisons between products fulfilling the same function" (ISO, 2006). This follows the structure and applies a Life-Cycle Assessment approach to the entire Product stage from raw material through manufacturing (A1-A3))

Kompan A/S
 C.F. Tietgens Boulevard 32C
 DK-5220 Odense SØ
 Denmark



Verification of CO₂ calculation of: Freestanding play equipment



Data version no. 2023-10-05

The CO₂ calculation and data are in compliance with the principles of a carbon footprint impact according to the GHG protocol (Greenhouse Gas Protocol), Scope 3, cradle to gate related to all individual components in the product category: "Freestanding play equipment" represented by item no.: GXY916012-3417.

(Scope 3 emissions include emission sources in the upstream and downstream value chain).

Date: 30. October 2023 | Valid until: 30. October 2025

Verified by:

Julie Marie Vejsgaard Larsen, LCA & EPD Consultant

Verification based on report: Validation of CO₂ calculation of 9 categories of Kompan product line, version 1.0, prepared by: Bureau Veritas HSE, Denmark: Julie M. V. Larsen.

Publication date: 30. October 2023

By Bureau Veritas HSE
 www.bureauveritas.dk
 +45 7731 1000



Horse, Double

PCM106

* Max fall height | ** Total height | *** Safety surfacing area

* Max fall height | ** Total height

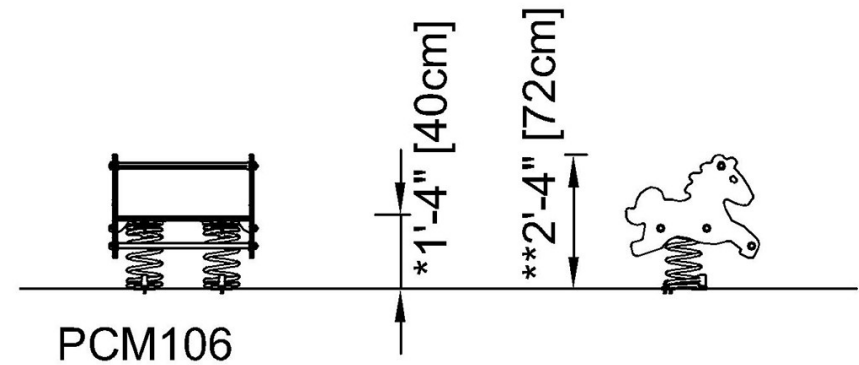
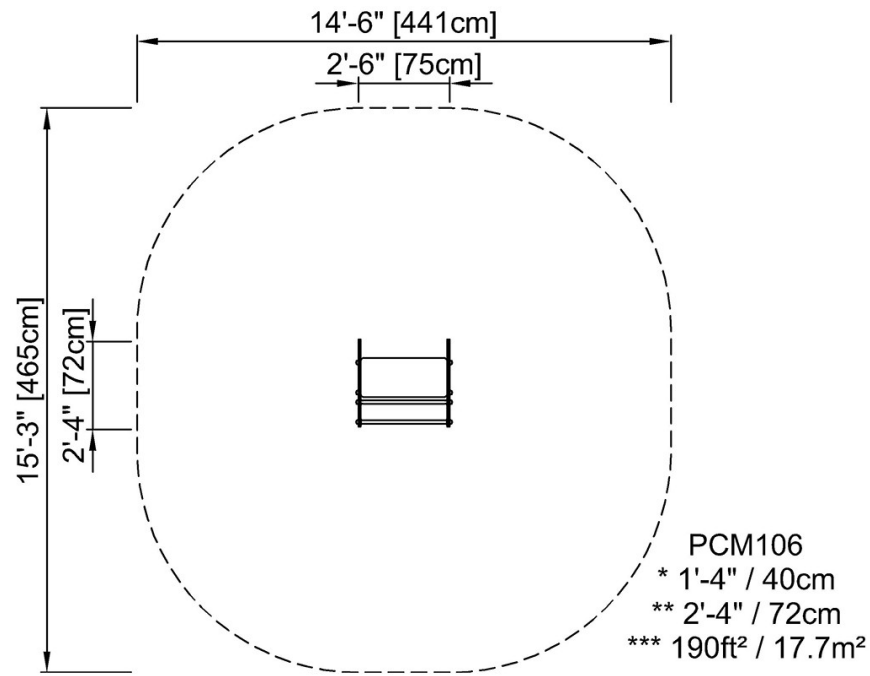

[Click to see TOP VIEW](#)

[Click to see SIDE VIEW](#)