

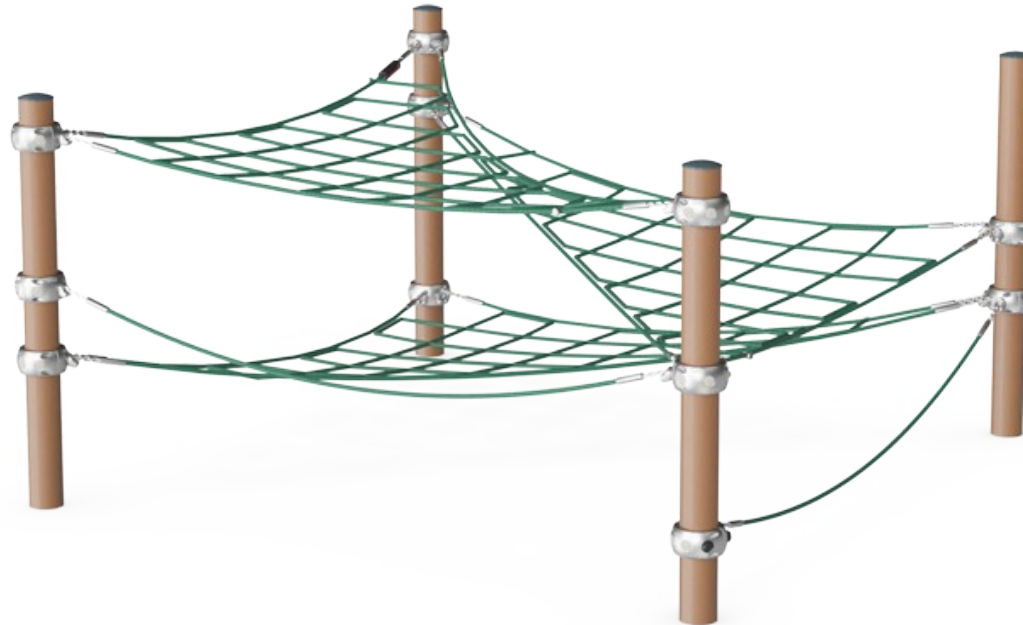

# Spix's Trail

CRP250701



Item no. CRP250701-0902

### General Product Information

Dimensions LxWxH	315x314x167 cm
Age group	6+
Play capacity (users)	12
Colour options	  

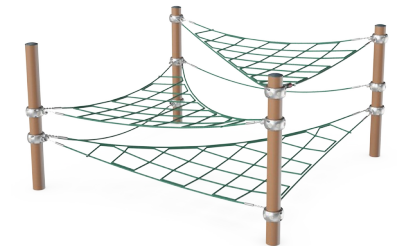
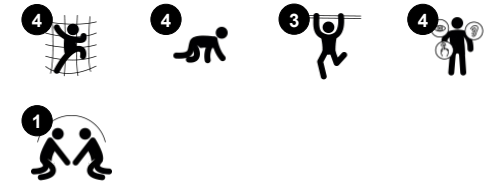

Children love climbing challenges, and this is what the Spix's Trail offers. It will attract children back to play again and again with its slick, versatile layers of climbing and chilling opportunities. The Spix's Trail will test children's agility, balance and coordination. These are fundamental motor skills that help children build body confidence, necessary for

overall well-being as well as for navigating the world, e.g. street traffic, securely. The Spix's Trail has room for many children to play together, which encourages children to socialize and make space for each other. The possibilities for movement and socialization are the perfect combination of activity and friendship-building. All in all, the Spix's Trails

invites children for a fun, playful and positive play experience.



Data is subject to change without prior notice.

# Spix's Trail

CRP250701

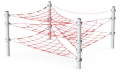

## Spix's Trail

**Physical:** children develop cross-body coordination and sense of balance when balancing on and climbing the nets. **Social-Emotional:** the big meshes allow for more children being seated or lying together.

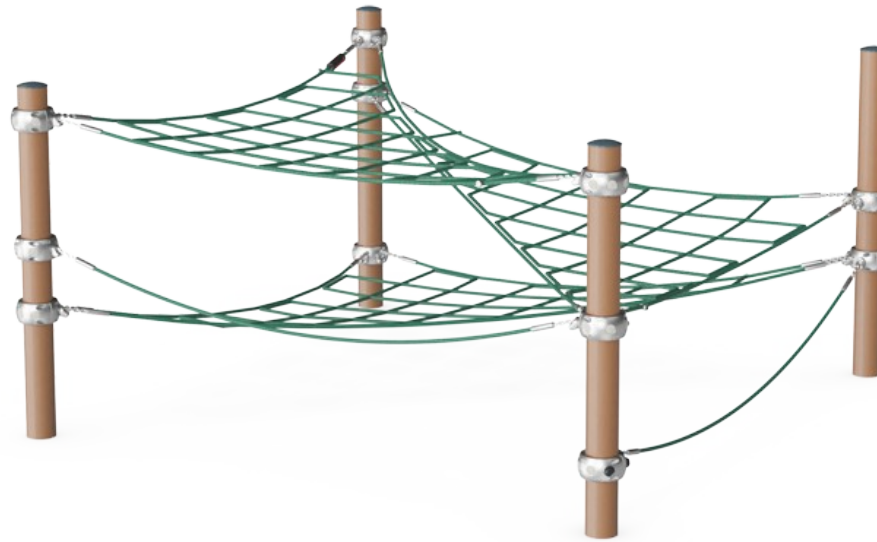

# Spix's Trail

CRP250701



Ropes of UV-stabilized PES rope strands with inner steel cable reinforcement. The polyester yarn is made from +95% post-consumer materials and is inductively melted onto each strand.



Corocord 'S' clamps are used as universal connections in Corocord products. 8mm stainless steel rods with rounded edges are pressed around the ropes with a special hydraulic press, making them the ideal connector: safe, durable and vandalism-proof, all while allowing the typical movement of rope play structures.



Colored steel components have a base of hot dip galvanization and a powder coated top finish. This provides an ultimate corrosion resistance in all climates around the world. Other steel surfaces are hot dip galvanized inside and outside with lead free zinc.



Corocord smart clamps are carefully designed in every detail to ensure superior flexibility in high quality aluminum material. The smart clamps are attached around the posts with four steel bolts. Not used attachment points are closed with PA caps.

Item no. CRP250701-0902	
Installation Information	
Max. fall height	150 cm
Safety surfacing area	35.0 m <sup>2</sup>
Total installation time	10.6
Excavation volume	7.06 m <sup>3</sup>
Concrete volume	3.92 m <sup>3</sup>
Footing depth (standard)	90 cm
Shipment weight	463 kg
Anchoring options	Surface ✓ In-ground ✓
Warranty Information	
Aluminium clamps	10 years
Hot dip galvanised steel	Lifetime
Painted toplayer	10 years
Ropes & nets	10 years
Spare parts guaranteed	10 years



# Sustainability Data

CRP250701

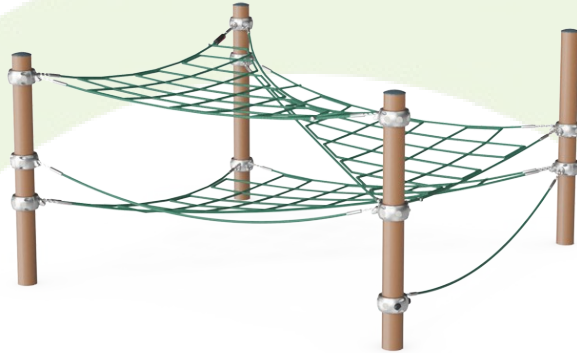

Cradle to Gate A1-A3	Total CO <sub>2</sub> emission	CO <sub>2</sub> e/kg	Recycled materials
	kg CO <sub>2</sub> e	kg CO <sub>2</sub> e/kg	%
<b>CRP250701-0902</b>	1,014.71	3.41	47.27

The overall framework applied for these factors is the Environmental Product Declaration (EPD), which quantifies "environmental information on the life cycle of a product and enable comparisons between products fulfilling the same function" (ISO, 2006). This follows the structure and applies a Life-Cycle Assessment approach to the entire Product stage from raw material through manufacturing (A1-A3))

**Kompan A/S**  
C.F. Tietgens Boulevard 32C  
DK-5220 Odense SØ  
Denmark



## Verification of CO<sub>2</sub> calculation of: Corocord



Data version no. 2023-10-05

The CO<sub>2</sub> calculation and data are in compliance with the principles of a carbon footprint impact according to the GHG protocol (Greenhouse Gas Protocol), Scope 3, cradle to gate related to all individual components in the product category: "Corocord" represented by item no.: COR314011-1101.

(Scope 3 emissions include emission sources in the upstream and downstream value chain).

**Date: 30. October 2023 | Valid until: 30. October 2025**

Verified by:

Julie Marie Vejsgaard Larsen, LCA & EPD Consultant

Verification based on report: Validation of CO<sub>2</sub> calculation of 9 categories of Kompan product line, version 1.0, prepared by: Bureau Veritas HSE, Denmark: Julie M. V. Larsen.

**Publication date: 30. October 2023**

By Bureau Veritas HSE  
www.bureauveritas.dk  
+45 7731 1000



# Spix's Trail

CRP250701

\* Max fall height | \*\* Total height | \*\*\* Safety surfacing area

\* Max fall height | \*\* Total height

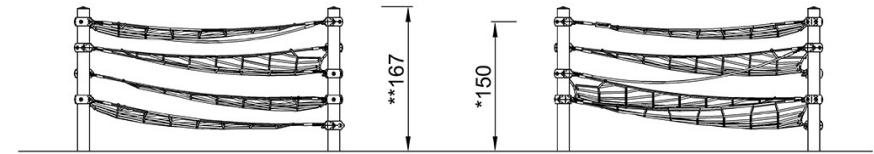
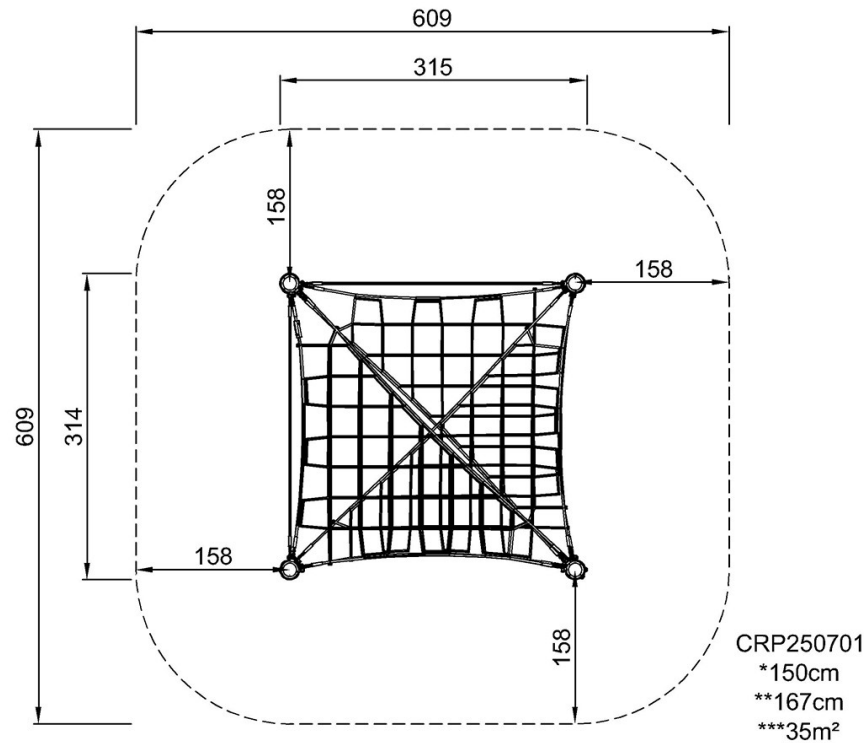

CRP250701

[Click to see TOP VIEW](#)

[Click to see SIDE VIEW](#)