

# Toddler Carriage

M537



Item no. M53701-3418P	
<b>General Product Information</b>	
Dimensions LxWxH	96x96x132 cm
Age group	1+
Play capacity (users)	3
Colour options	



The delightful Toddler Carriage is a great meeting point for toddlers. It functions perfectly in combination with the Toddler Train. The through and meeting options offer physical and social play. The traffic theme will spur children's imagination: where are we going on the train? The toddlers enjoy moving their bodies around the train. This trains the cross-

coordination, which is crucial to train for toddlers. The cross-coordination supports the functions in the brain that facilitate later reading skills. Thanks to the semi-open sides and the doorways and window holes, social interactions are supported from the inside to the outside. Care giver interaction is made easier, and the holes invite a nice round of peek-a-boo. In spite

of transparency, the Train still provides corners for toddlers to play den in.

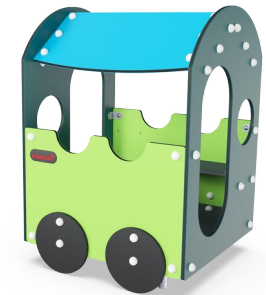

# Toddler Carriage

M537



## Theme

**Cognitive:** suggests a theme and supports dramatic play, which stimulates language and communication skills.

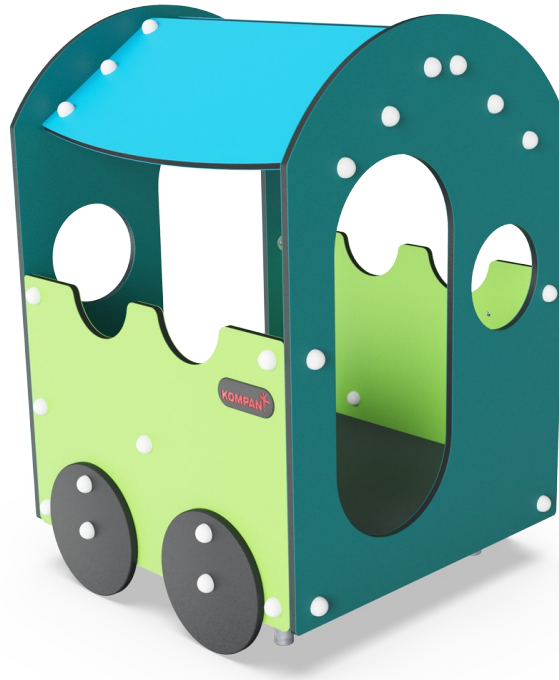

## Bench

**Social-Emotional:** gathering, cooperating or taking a break from play - all train social skills.

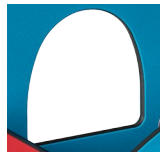

## Window

**Social-Emotional:** invites interaction between sides and cooperative play.

# Toddler Carriage

M537

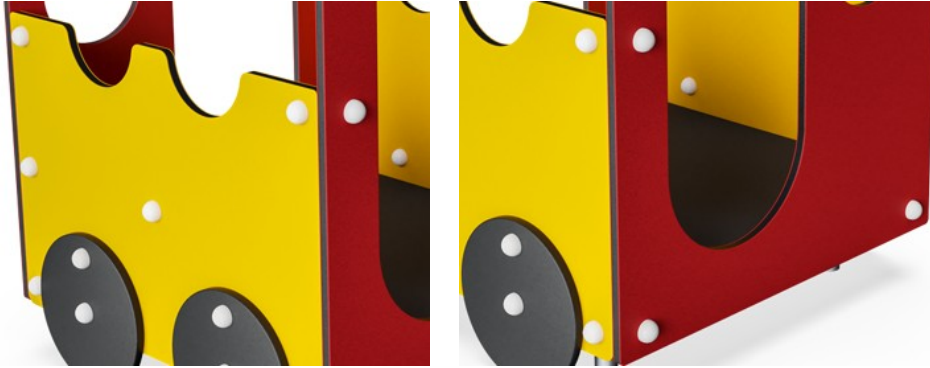

Panels of 19mm EcoCore™. EcoCore™ is a highly durable, eco friendly material, which is not only recyclable after use, but also consists of material produced from +95% recycled post consumer material from food packing waste.



Floor is made of HPL with a thickness 10 mm and non skid surface texture according to EN 438-6. KOMPAN HPL has high wearing strength to ensure long lifetime in all climates.



KOMPAN GreenLine versions are designed with ultimate environmentally friendly materials with lowest possible CO2e emission factor such as EcoCore™ panels of +95% post consumer recycled ocean waste.

Item no. M53701-3418P

### Installation Information

Max. fall height	48 cm
Safety surfacing area	13.4 m <sup>2</sup>
Total installation time	5.2
Excavation volume	0.09 m <sup>3</sup>
Concrete volume	0.00 m <sup>3</sup>
Footing depth (standard)	60 cm
Shipment weight	152 kg
Anchoring options	In-ground ✓ Surface ✓

### Warranty Information

EcoCore HDPE	Lifetime
HPL decks	15 years
Movable parts	2 years
Spare parts guaranteed	10 years



# Sustainability Data

M537



<b>Cradle to Gate A1-A3</b>	<b>Total CO<sub>2</sub> emission</b>	<b>CO<sub>2</sub>e/kg</b>	<b>Recycled materials</b>
	kg CO <sub>2</sub> e	kg CO <sub>2</sub> e/kg	%
<b>M53701-3418P</b>	154.40	1.47	66.45

The overall framework applied for these factors is the Environmental Product Declaration (EPD), which quantifies "environmental information on the life cycle of a product and enable comparisons between products fulfilling the same function" (ISO, 2006). This follows the structure and applies a Life-Cycle Assessment approach to the entire Product stage from raw material through manufacturing (A1-A3))

# Toddler Carriage

M537

\* Max fall height | \*\* Total height | \*\*\* Safety surfacing area

\* Max fall height | \*\* Total height

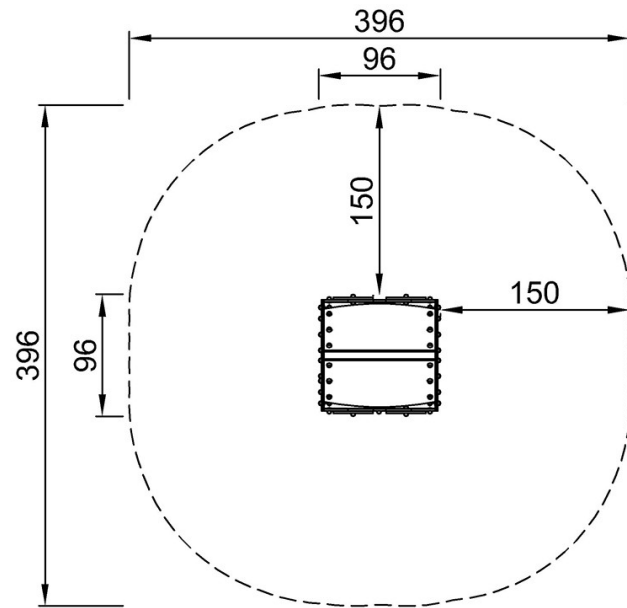

M53701  
\*48cm  
\*\*132cm  
\*\*\*13.4m<sup>2</sup>

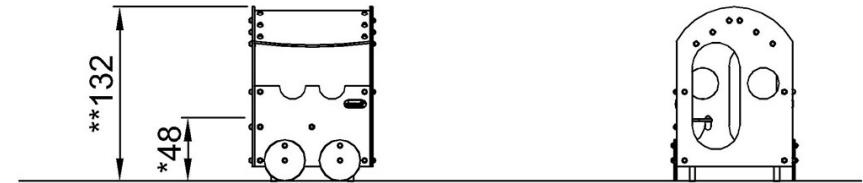

M53701

[Click to see TOP VIEW](#)

[Click to see SIDE VIEW](#)