

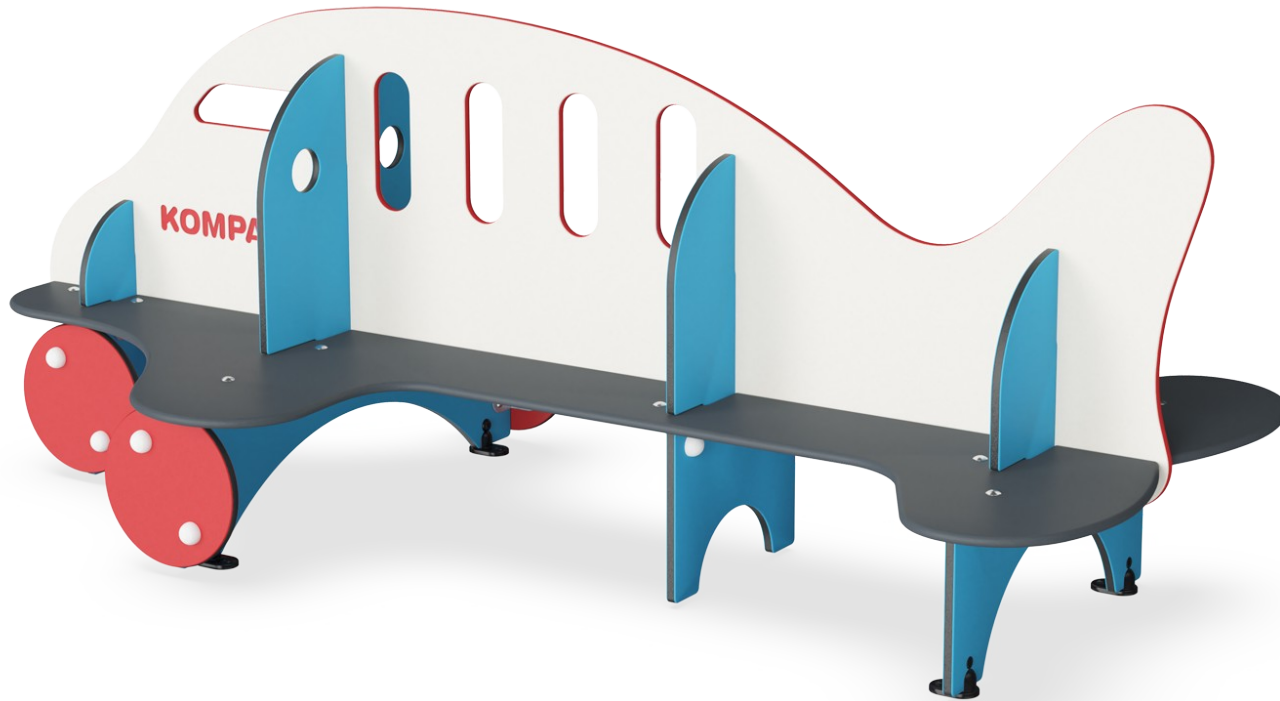

Jumbo Bench

M240



Item no. M24070-3218P

General Product Information

Dimensions LxWxH	242x128x95 cm
Age group	6m+
Play capacity (users)	6
Colour options	



The Jumbo Bench is much more than meets the eye. This playful structure supports social-emotional as well as physical skills in young children. The considerate design helps children to stay and play, which provides developmental benefits and great fun. In addition to being a place to sit alone or talk with friends, the Jumbo will encourage conversations

concerning the theme of flying. Sitting with friends supports social-emotional development and the life skills of interpersonal communication. The imaginative theme play supports cognitive development and thinking skills. The windows of the plane enhance this by providing children with opportunities to play peek-a-boo and other simple games. For

younger children, pulling themselves up to stand supports physical development.



Jumbo Bench

M240

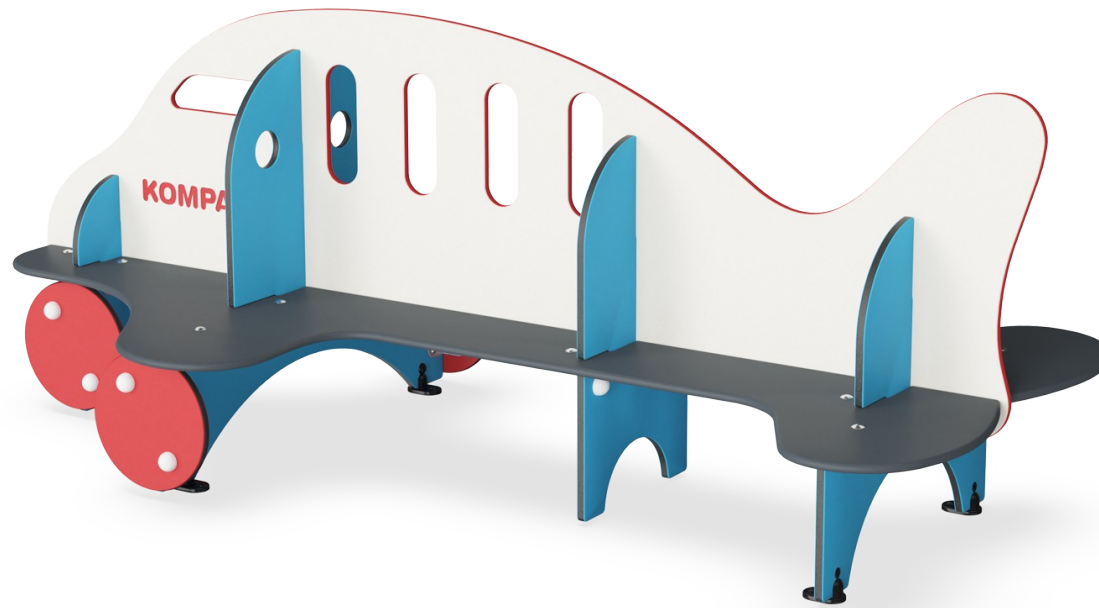

Theme

Cognitive: suggests a theme and supports dramatic play, which stimulates language and communication skills.



Bench

Social-Emotional: gathering, cooperating or taking a break from play - all train social skills.

Jumbo Bench

M240



Panels are made from 19 mm HDPE material. The HDPE panels are highly durable and 100% recyclable after use and have a black centre core which is a 100% recycled material.



The seating area is made of HPL with a thickness of 17.8 mm. KOMPAN HPL has high wearing strength to ensure longevity in all climates.

Item no. M24070-3218P

Installation Information

Max. fall height	35 cm
Safety surfacing area	19.0 m ²
Total installation time	4.4
Excavation volume	0.13 m ³
Concrete volume	0.00 m ³
Footing depth (standard)	32 cm
Shipment weight	166 kg
Anchoring options	In-ground ✓ Surface ✓

Warranty Information

EcoCore HDPE	Lifetime
HPL Seat	15 years
Spare Parts Guarantee	10 years



Sustainability Data

M240

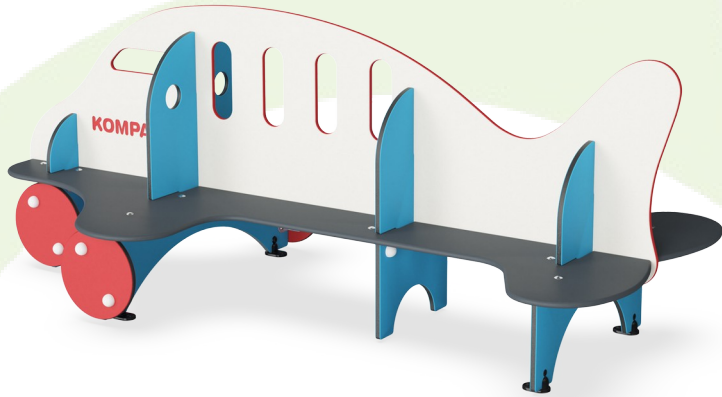

Cradle to Gate A1-A3	Total CO ₂ emission	CO ₂ e/kg	Recycled materials
	kg CO ₂ e	kg CO ₂ e/kg	%
M24070-3218P	166.29	1.73	46.50

The overall framework applied for these factors is the Environmental Product Declaration (EPD), which quantifies "environmental information on the life cycle of a product and enable comparisons between products fulfilling the same function" (ISO, 2006). This follows the structure and applies a Life-Cycle Assessment approach to the entire Product stage from raw material through manufacturing (A1-A3))

Kompan A/S
 C.F. Tietgens Boulevard 32C
 DK-5220 Odense SØ
 Denmark



Verification of CO₂ calculation of: Themed play systems

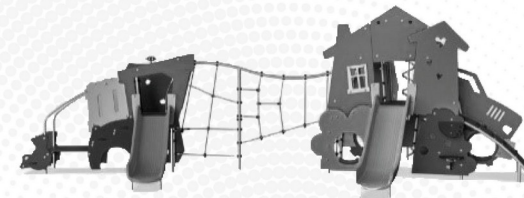

Data version no. 2023-10-05

The CO₂ calculation and data are in compliance with the principles of a carbon footprint impact according to the GHG protocol (Greenhouse Gas Protocol), Scope 3, cradle to gate related to all individual components in the product category: "Themed play systems" represented by item no.: MSC641100-3717P.

(Scope 3 emissions include emission sources in the upstream and downstream value chain).

Date: 30. October 2023 | Valid until: 30. October 2025

Verified by:

Julie Marie Vejsgaard Larsen, LCA & EPD Consultant

Verification based on report: Validation of CO₂ calculation of 9 categories of Kompan product line, version 1.0, prepared by: Bureau Veritas HSE, Denmark: Julie M. V. Larsen.

Publication date: 30. October 2023

By Bureau Veritas HSE
 www.bureauveritas.dk
 +45 7731 1000



Jumbo Bench

M240

* Max fall height | ** Total height | *** Safety surfacing area

* Max fall height | ** Total height

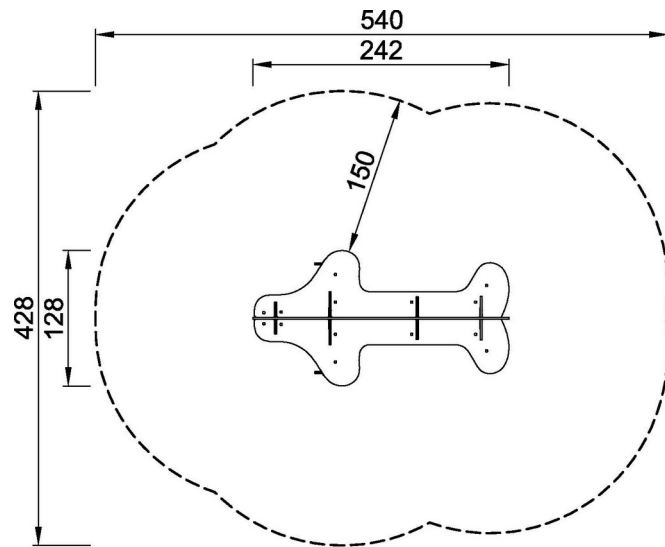

M24070P-xx18
*35cm
**95cm
***19m²

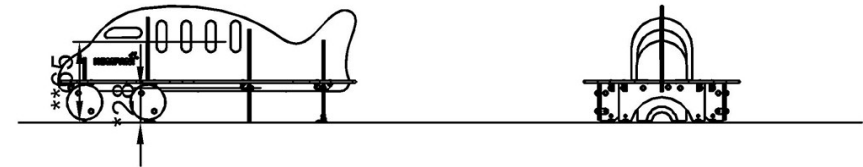

M24070P
1:100

[Click to see TOP VIEW](#)

[Click to see SIDE VIEW](#)