

# Waterfall with Sand Table

PCM505

**KOMPANI**  
Let's play

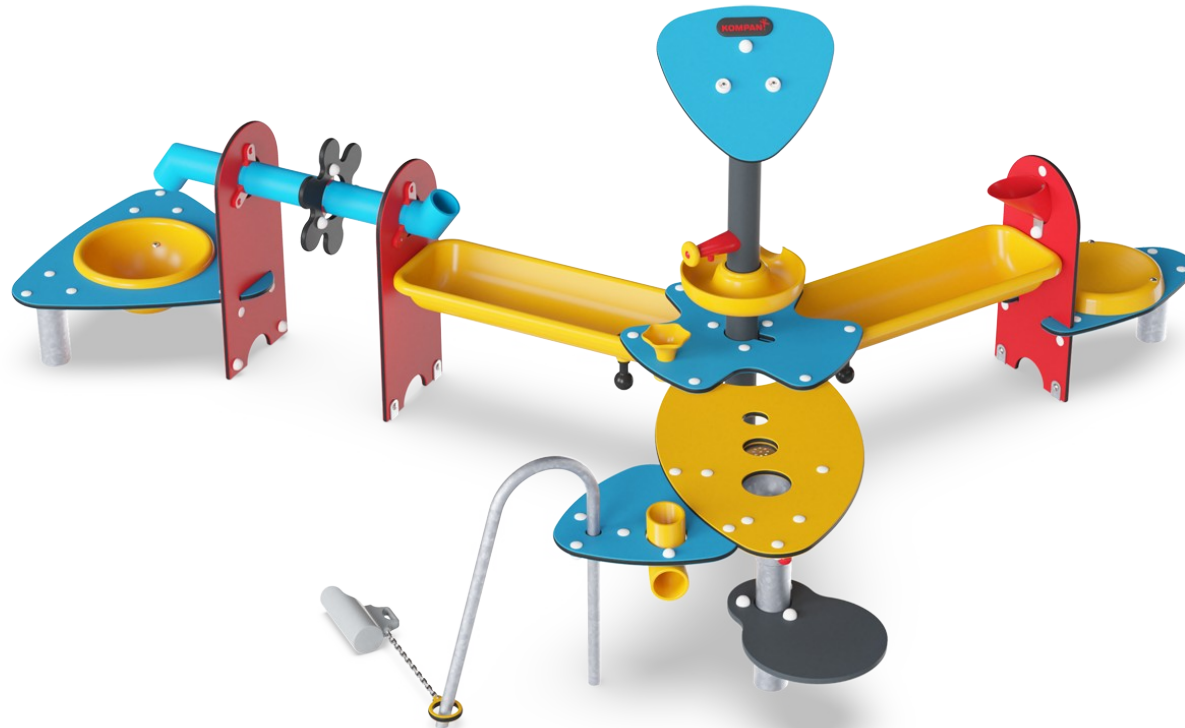

The star-shaped Waterfall with its vivid, warm colors attracts children again and again. The richness of tactile activities to be explored invites deep play and makes the child want to stay and play for a long time. The star shape makes social play possible as all children can see the other children playing, get inspired and communicate with one another. The yellow

basins can be emptied by pulling the black water stoppers. Children will do this, again and again, to watch the water running out under the basin. The red water tub with dispenser in the middle of the star opens when pressed and closes when not. This means that all users can open or close the water tap in some way. There is ample table and seating space, allowing for

creative play with sand and water. With the proper surfacing solution, the piece can be used and accessed from all sides by all users.

Item no. PCM505-0601

## General Product Information

Dimensions LxWxH	12'11"x10'0"x5'2"
Age group	2 - 5
Play capacity (users)	17
Color options	 



# Waterfall with Sand Table

PCM505

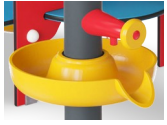

## Red water dispenser

**Social-Emotional:** supports cooperation and negotiation skills when figuring out where to funnel water. Opens when pushed with hand, elbow, foot, chin or shoulder. Placed to also be reachable from a seated position.

**Cognitive:** develops logical thinking in distributing the water to the basin intended, or elsewhere. **Creative:** mixing the water with various grained materials into new, shapeable material stimulates the urge to create in children.

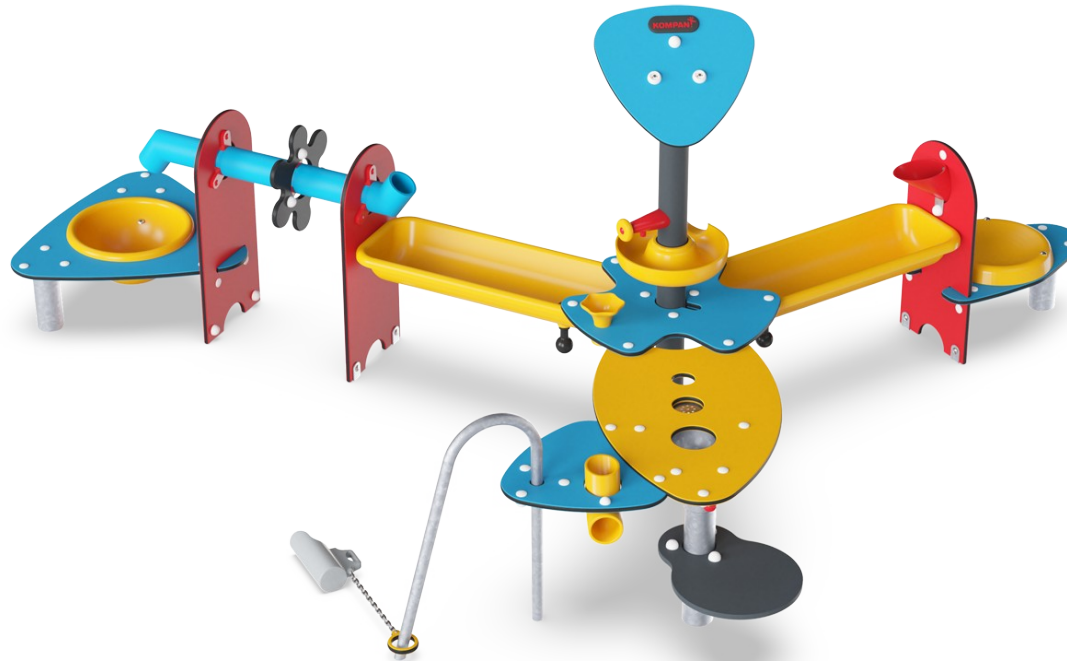

## Yellow basin with black rubber stop

**Cognitive:** logical thinking and understanding of cause and effect are trained when children stop or let go of water from the basin.

**Creative:** the water plug makes changing water levels possible, which adds to logical thinking skills.



## Water basin

**Social-Emotional:** meeting point for cooperation and sharing. **Cognitive:** the basin can be lifted and emptied, adding to play as well as to logical thinking skills.



## Funnel

**Social-Emotional:** trains cooperation and turn-taking as children put materials into the funnel. **Cognitive:** the passing of materials through funnels supports the children's logical thinking and for younger children the understanding of object permanence: that materials don't vanish but run through at the other end.



## Long water tube

**Social-Emotional:** children cooperate and communicate from both ends when running water through the tube. **Cognitive:** supports logical thinking and cause and effect understanding when children wait for the water to run through.



## Sand shovel

**Physical:** develops dexterity and upper body muscles. **Cognitive:** understanding of object permanence, emptying and filling scoop.



## Sieve

**Creative:** sand can be shifted through the sieve, for understanding of cause and effect and object permanence.

# Waterfall with Sand Table

PCM505

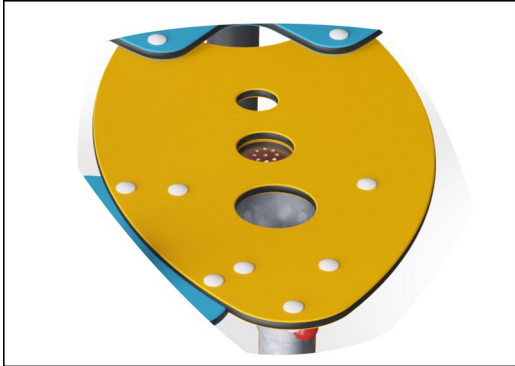

Panels of 19mm EcoCore™. EcoCore™ is a highly durable, eco friendly material, which is not only recyclable after use, but also consists of a core produced from 100% recycled material.

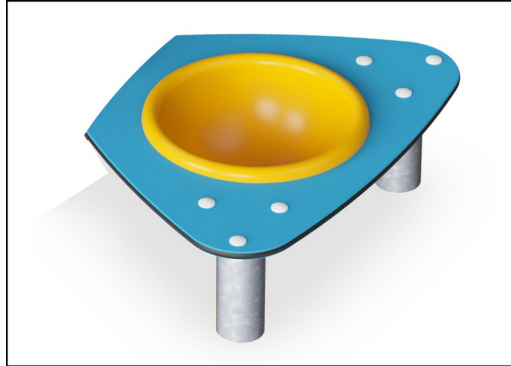

Yellow basin is made from UV-stabilized PC with a thickness of 3 mm. The basin can be lifted up for emptying. The basin is fixed to the structure by a steel chain to prevent removal.



The main posts are made of high quality pre-galvanized steel with powder coated top finish equipped with hot dip galvanized steel footings. Other metal parts are hot dip galvanized.



Long basin is made of pressure molded high quality nylon (PA6). PA6 has good wearing and impact strength.



Play activities like the Funnel Cone are made of glass fiber. Glass fiber has good wearing and impact strength.



The integrated water tap open for water when pushed and stops when letting go. The water is supplied trough a pipe located inside the post with hose or pipe connection at the bottom of the post. The supply can either a loose hose or a permanent in-ground plumbing.

Item no. PCM505-0601	
Installation Information	
Max. fall height	0'0"
Safety surfacing area	0ft²
Total installation time	8.5
Excavation volume	1.73yd³
Concrete volume	0yd³
Footing depth (standard)	2'1"
Shipment weight	571lbs
Anchoring options	In-ground ✓ Surface ✓
Warranty Information	
EcoCore HDPE	Lifetime
Hot dip galvanized steel	Lifetime
Solid plastic parts	10 Years
Spare Parts Availability	10 Years
Stainless steel components	Lifetime

Elevated activities 0	Accessible elevated activities	Accessible ground level activities	Accessible ground level play types
Present	0	1	1
Required	0	1	1



# Sustainability Data

PCM505

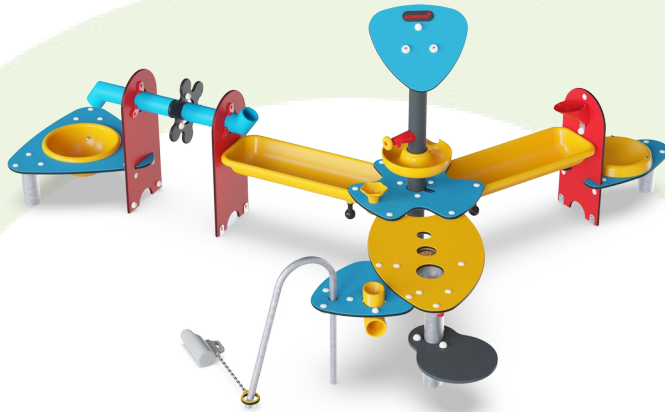

Cradle to Gate A1-A3	Total CO <sub>2</sub> emission	CO <sub>2</sub> e/kg	Recycled materials
	kg CO <sub>2</sub> e	kg CO <sub>2</sub> e/kg	%
<b>PCM505-0601</b>	336.85	2.20	53.85

The overall framework applied for these factors is the Environmental Product Declaration (EPD), which quantifies "environmental information on the life cycle of a product and enable comparisons between products fulfilling the same function" (ISO, 2006). This follows the structure and applies a Life-Cycle Assessment approach to the entire Product stage from raw material through manufacturing (A1-A3))

**Kompan A/S**  
C.F. Tietgens Boulevard 32C  
DK-5220 Odense SØ  
Denmark



## Verification of CO<sub>2</sub> calculation of: Themed play systems



Data version no. 2023-10-05

The CO<sub>2</sub> calculation and data are in compliance with the principles of a carbon footprint impact according to the GHG protocol (Greenhouse Gas Protocol), Scope 3, cradle to gate related to all individual components in the product category: "Themed play systems" represented by item no.: MSC641100-3717P.

(Scope 3 emissions include emission sources in the upstream and downstream value chain).

**Date: 30. October 2023 | Valid until: 30. October 2025**

Verified by:

Julie Marie Vejsgaard Larsen, LCA & EPD Consultant

Verification based on report: Validation of CO<sub>2</sub> calculation of 9 categories of Kompan product line, version 1.0, prepared by: Bureau Veritas HSE, Denmark: Julie M. V. Larsen.

**Publication date: 30. October 2023**

By Bureau Veritas HSE  
www.bureauveritas.dk  
+45 7731 1000



# Waterfall with Sand Table

PCM505

\* Max fall height | \*\* Total height | \*\*\* Safety surfacing area

\* Max fall height | \*\* Total height

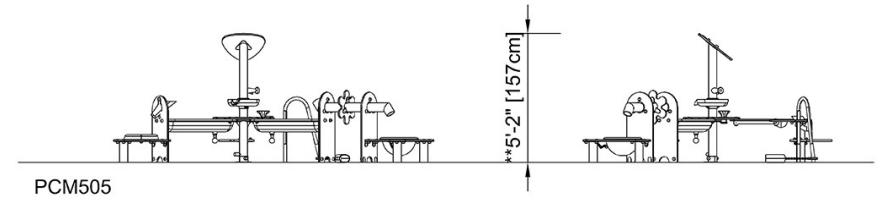
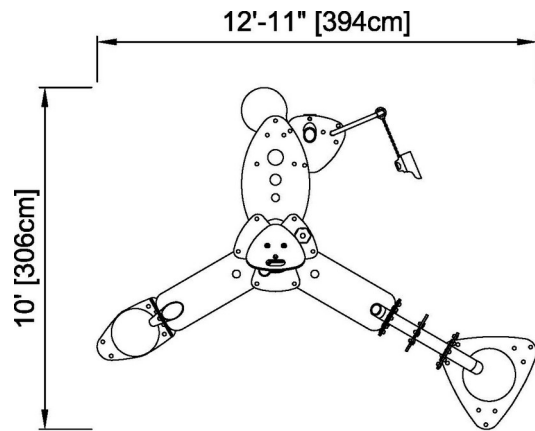

PCM505  
\*\* 5'-2" / 157cm

[Click to see TOP VIEW](#)

[Click to see SIDE VIEW](#)