



# Triple Tower

KPL3010



Item no. KPL301011-0902	
General Product Information	
Dimensions LxWxH	429x389x402 cm
Age group	4+
Play capacity (users)	19
Colour options	 

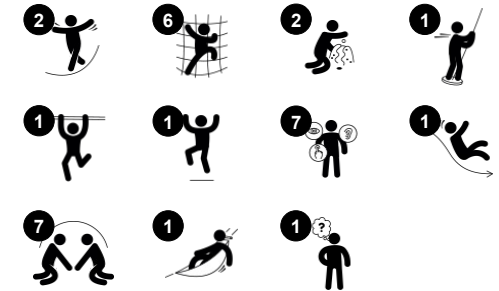

This wonderful combination of fun and challenging play activities creates an irresistible play unit. Children will try it out and come back for more play, again and again. The layers of challenging play add something new to try out in every corner. And the varied play panels on ground level create corners for quieter play breaks also. The tall tower with the

dare devil fireman's pole and the vertical climbing wall is great training of muscles and motor skills for the oldest. It can be accessed also from the inclined balancing beam from the lower tower, creating a truly challenging balance act. The senses of balance and space are trained immensely when playing on the balance beam. When climbing the tall net, the

proprioception and muscles are used intensely. The proprioception is fundamental in navigating the world securely and for judging distances, for instance in traffic.

# Triple Tower

KPL3010



## Climbing pole

**Physical:** cross coordination and muscle strength are trained. **Social-Emotional:** turn-taking and cooperation.

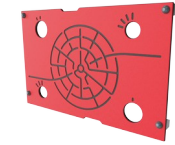

## Maze panel

**Social-Emotional:** communication and cooperation exploring the maze with friends. **Cognitive:** stimulates memory when memorizing maze routes.



## Plank bridge

**Physical:** balancing across the plank develops the vestibular system as well as cross coordination. **Social-Emotional:** passing other children takes co-operation and teaches children turn-taking skills.



## Fireman's pole

**Physical:** coordination is supported when going down, as well as arm and core muscles. Landing strengthens bone density, which is built for life in early childhood. **Social-Emotional:** turn-taking and risk-taking.



## Climbing net

**Physical:** children develop cross-body coordination and muscle strength when climbing. The big meshes allow for climbing and crawling through, supporting proprioception and spatial awareness. **Social-Emotional:** the big meshes allow for more children to sit together and talk.

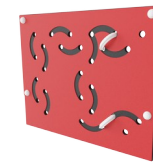

## Ring game

**Social-Emotional:** cooperating from both sides on running rings up and down trains turn-taking and cooperation skills. **Cognitive:** figuring out how to turn the ring to make it fit the holes and move up or down trains logical skills. **Creative:** leaving rings in new positions leaves a mark in the playground.

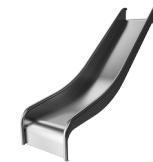

## Slide

**Physical:** sliding develops spatial awareness and a sense of balance. Furthermore, the core muscles are trained when sitting upright going down. **Social-Emotional:** empathy stimulated by turn-taking.

# Triple Tower

KPL3010



Panels of 19mm EcoCore™. EcoCore™ is a highly durable, eco friendly material, which is not only recyclable after use, but also consists of material produced from +95% recycled post consumer material from food packing waste.



The main tower posts are available in two types of material: European pine wood posts, pressure impregnated Class 3 with Tanalith E3475 according to EN335 (Equivalent to NTR Class AB). Aluminum post t=2mm with anodized surface treatment. Base material EN AW-6060 T66.

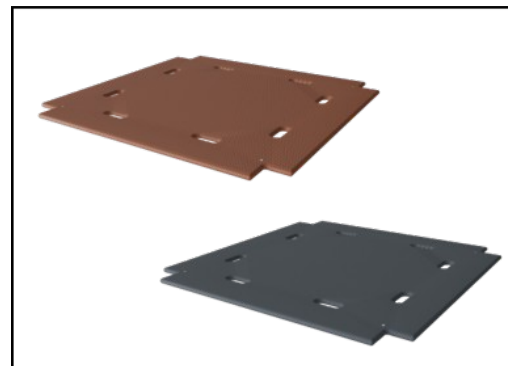

Floors and panel activities are available in two types of material: Waterproof plywood decks thickness 21.5mm from pine and alder wood with anti-slip film on both sides. High Pressure Laminate HPL thickness 17.8mm with slip resistant surface texture according to EN 438-6.

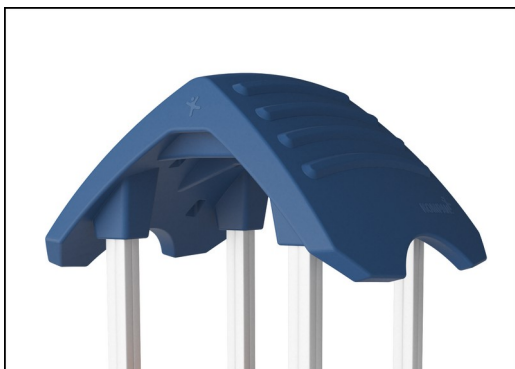

The large hollow components are made of 100% recyclable PE. The roof displayed is moulded in one piece with minimum 5,5mm wall thickness to ensure high durability in all climates around the world.

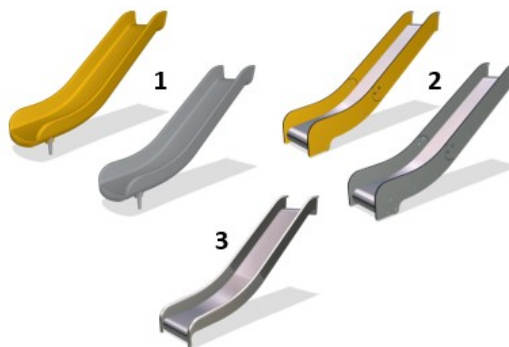

Slides are available in three different materials: moulded on piece PE slides made from 33% post-consumer materials, Combined EcoCore™ sides and stainless steel slide bed t=2mm. Full stainless steel AISI304 t=2mm.



Climbing nets are made of UV-stabilised PP rope with inner steel cable reinforcement. The rope is induction treated to obtain maximum fixation between steel and rope which provides excellent wear and tear resistance. All rope connectors are made of 100% recyclable PA material.

Item no. KPL301011-0902

### Installation Information

Max. fall height	178 cm
Safety surfacing area	45.5 m <sup>2</sup>
Total installation time	18.1
Excavation volume	1.68 m <sup>3</sup>
Concrete volume	0.76 m <sup>3</sup>
Footing depth (standard)	90 cm
Shipment weight	594 kg
Anchoring options	In-ground ✓ Surface ✓

### Warranty Information

Aluminum	15 years
EcoCore HDPE	Lifetime
Pinewood	10 years
Ropes & nets	10 years
Spare parts guaranteed	10 years



# Sustainability Data

KPL3010



Cradle to Gate A1-A3	Total CO <sub>2</sub> emission	CO <sub>2</sub> e/kg	Recycled materials
	kg CO <sub>2</sub> e	kg CO <sub>2</sub> e/kg	%
<b>KPL301011-0902</b>	657.31	1.47	33.67

The overall framework applied for these factors is the Environmental Product Declaration (EPD), which quantifies "environmental information on the life cycle of a product and enable comparisons between products fulfilling the same function" (ISO, 2006). This follows the structure and applies a Life-Cycle Assessment approach to the entire Product stage from raw material through manufacturing (A1-A3))

**Kompan A/S**  
 C.F. Tietgens Boulevard 32C  
 DK-5220 Odense SØ  
 Denmark



## Verification of CO<sub>2</sub> calculation of: Play systems



Data version no. 2023-10-05

The CO<sub>2</sub> calculation and data are in compliance with the principles of a carbon footprint impact according to the GHG protocol (Greenhouse Gas Protocol), Scope 3, cradle to gate related to all individual components in the product category: "Play systems" represented by item no.: PCM200321-0950.

(Scope 3 emissions include emission sources in the upstream and downstream value chain).

**Date: 30. October 2023 | Valid until: 30. October 2025**

Verified by:

Julie Marie Vejsgaard Larsen, LCA & EPD Consultant

Verification based on report: Validation of CO<sub>2</sub> calculation of 9 categories of Kompan product line, version 1.0, prepared by: Bureau Veritas HSE, Denmark: Julie M. V. Larsen.

**Publication date: 30. October 2023**

By Bureau Veritas HSE  
 www.bureauveritas.dk  
 +45 7731 1000



# Triple Tower

KPL3010

\* Max fall height | \*\* Total height | \*\*\* Safety surfacing area

\* Max fall height | \*\* Total height

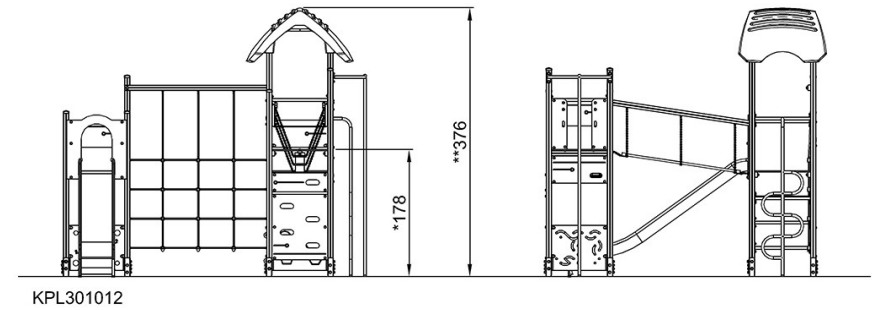
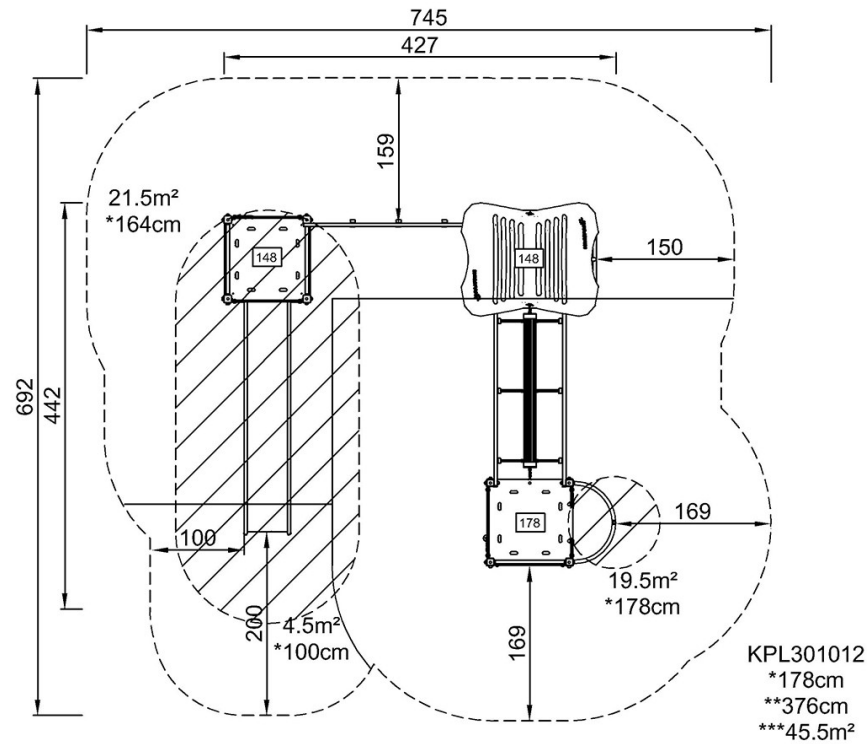

[Click to see TOP VIEW](#)

[Click to see SIDE VIEW](#)