

Slide, 1.8m high

PCM303



Item no. PCM303-0950

General Product Information

Dimensions LxWxH	65x426x256 cm
Age group	4+
Play capacity (users)	2
Colour options	

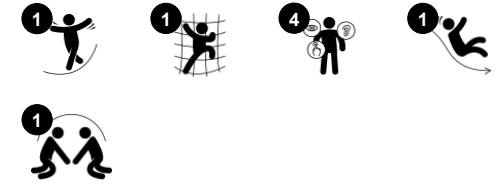

Sliding is a favorite playground activity that attracts children to being active and playful in a thrilling way. This sturdy slide will delight children and encourage them to be brave and enthusiastic on the playground, for hours of imaginative and active play. When children slide they train their core muscles, sitting upright while sliding down. This stimulates their

trunk stability, important for avoiding back and neck pains – a growing problem in children due to sedentary lifestyles. Sliding additionally trains the child's sense of balance and spatial understanding. These skills are important in navigating the world securely. They are the fundament of all motor skills and thus a fundament in physical confidence in the child.

The steps of the stair are ergonomically appropriate for little hands, adding a feeling of confidence to the climb.

Slide, 1.8m high

PCM303



Stair ladder

Physical: cross coordination is used, supporting the cooperation of the left and right halves of the brain, which is necessary for reading. For young children, spatial awareness is trained when walking stairs.

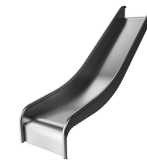

Slide

Physical: sliding develops spatial awareness and a sense of balance. Furthermore, the core muscles are trained when sitting upright going down. **Social-Emotional:** empathy stimulated by turn-taking.

Slide, 1.8m high

PCM303



Panels of 19mm EcoCore™. EcoCore™ is a highly durable, eco friendly material, which is not only recyclable after use, but also consists of material produced from +95% recycled post consumer material from food packing waste.



Steps are made of extruded aluminium with a non-skid surface. Aluminium has high corrosion resistance and ensures durability of the product.

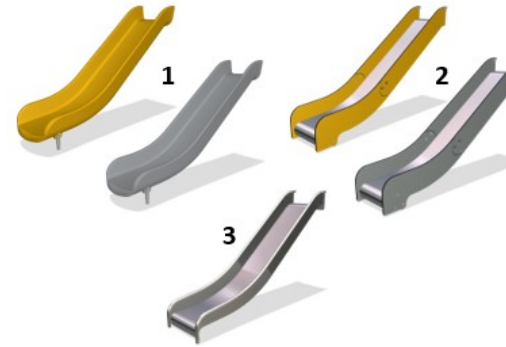

Slides are available in three different materials: moulded on piece PE slides made from 33% post-consumer materials, Combined EcoCore™ sides and stainless steel slide bed t=2mm. Full stainless steel AISI304 t=2mm.

Item no. PCM303-0950	
Installation Information	
Max. fall height	178 cm
Safety surfacing area	27.0 m ²
Total installation time	4.1
Excavation volume	0.43 m ³
Concrete volume	0.00 m ³
Footing depth (standard)	90 cm
Shipment weight	149 kg
Anchoring options	In-ground ✓ Surface ✓
Warranty Information	
EcoCore HDPE	Lifetime
PE slide	10 years
Spare parts guaranteed	10 years



GreenLine versions in teal color are designed with molded PE parts which consist of 33% recycled post-consumer ocean waste. Ocean waste is collected from the maritime industry, such as fishing nets, ropes and trawls.



Sustainability Data

PCM303



Cradle to Gate A1-A3	Total CO ₂ emission	CO ₂ e/kg	Recycled materials
	kg CO ₂ e	kg CO ₂ e/kg	%
PCM303-0950	191.66	1.74	53.76

The overall framework applied for these factors is the Environmental Product Declaration (EPD), which quantifies "environmental information on the life cycle of a product and enable comparisons between products fulfilling the same function" (ISO, 2006). This follows the structure and applies a Life-Cycle Assessment approach to the entire Product stage from raw material through manufacturing (A1-A3))

Kompan A/S
 C.F. Tietgens Boulevard 32C
 DK-5220 Odense SØ
 Denmark



Verification of CO₂ calculation of: Freestanding play equipment



Data version no. 2023-10-05

The CO₂ calculation and data are in compliance with the principles of a carbon footprint impact according to the GHG protocol (Greenhouse Gas Protocol), Scope 3, cradle to gate related to all individual components in the product category: "Freestanding play equipment" represented by item no.: GXY916012-3417.

(Scope 3 emissions include emission sources in the upstream and downstream value chain).

Date: 30. October 2023 | Valid until: 30. October 2025

Verified by:

Julie Marie Vejsgaard Larsen, LCA & EPD Consultant

Verification based on report: Validation of CO₂ calculation of 9 categories of Kompan product line, version 1.0, prepared by: Bureau Veritas HSE, Denmark: Julie M. V. Larsen.

Publication date: 30. October 2023

By Bureau Veritas HSE
 www.bureauveritas.dk
 +45 7731 1000



Slide, 1.8m high

PCM303

* Max fall height | ** Total height | *** Safety surfacing area

* Max fall height | ** Total height

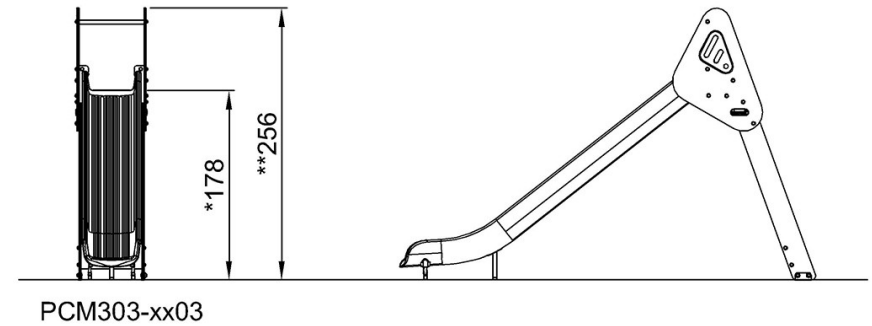
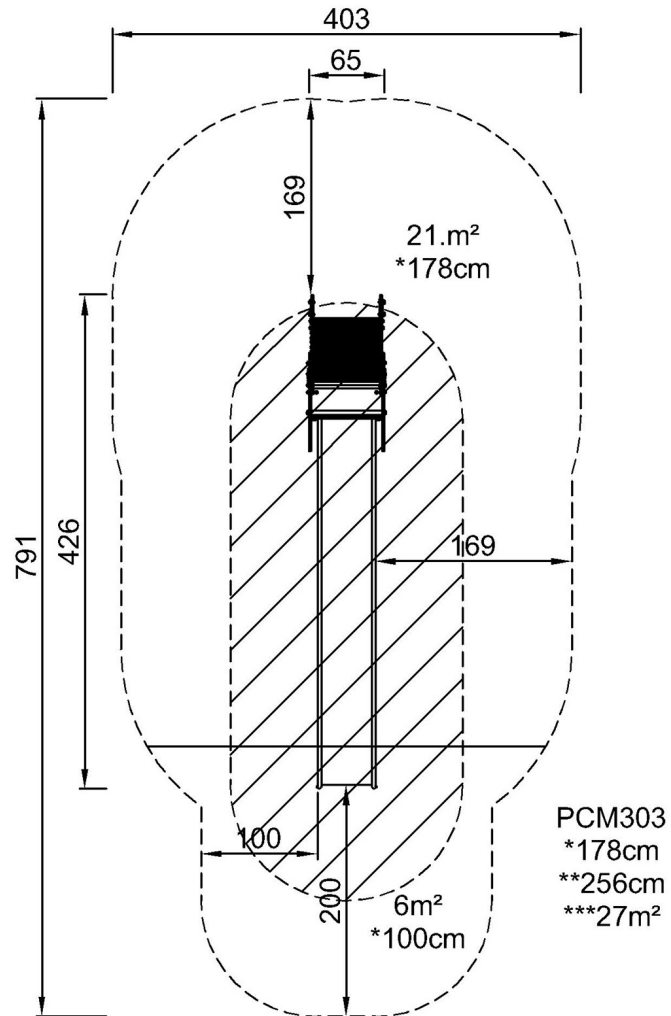

[Click to see TOP VIEW](#)

[Click to see SIDE VIEW](#)