



# Arch Ladder, 2.0m high

COR20210



Item no. COR202101-0301	
<b>General Product Information</b>	
Dimensions LxWxH	439x105x200 cm
Age group	5+
Play capacity (users)	20
Color options	 

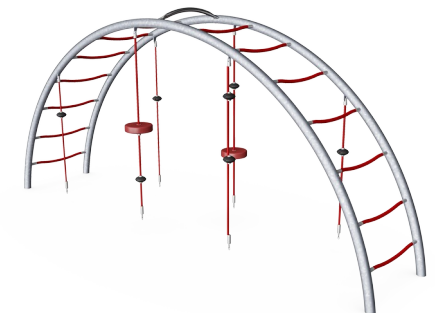
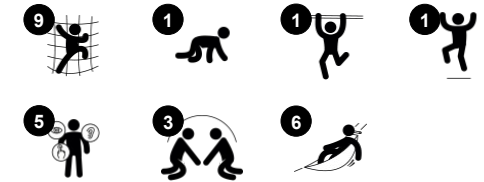

The Large Arc Ladder is an appealing climbing and meeting structure for the youngest players. The versatile climbing opportunities; up, down, through and across will attract children to return to play, again and again. The swaying ropes with seats and UFO's invite vertical climbing as well as a swaying rest with friends, seated or standing which stimulates social

interaction. The arc ladder makes a nice climb to the top, where children can get a great view from above. Apart from having great fun exploring play possibilities, children develop their cross-coordination and muscle strength when climbing and when passing others when climbing through trains turn-taking skills and consideration. These varied climbing

possibilities make it possible for both timid and courageous children to experience successful play and participate which is important for positive self perception.

# Arch Ladder, 2.0m high

COR20210



Corocord 16mm ropes of UV-stabilized PES rope strands with inner steel cable reinforcement. The polyester yarn is made from +95% post-consumer materials and is inductively melted onto each strand. The ropes are highly wear-and vandalism-resistant and can be replaced at site if needed.



The steel structure are hot dip galvanised inside and outside with lead free zinc. The galvanisation has excellent corrosion resistance in outside environments and requires low maintenance.



Fully coloured EPDM rubber discs with smooth surface. The moulded EPDM surrounds a hot dip galvanised steel core that ensures both the stability of the discs and durable fixation to the rope.

Item no. COR202101-0301

### Installation Information

Max. fall height	200 cm
Safety surfacing area	28.0 m <sup>2</sup>
Total installation time	5.9
Excavation volume	2.38 m <sup>3</sup>
Concrete volume	1.70 m <sup>3</sup>
Footing depth (standard)	90 cm
Shipment weight	200 kg
Anchoring options	In-ground ✓ Surface ✓



# Sustainability Data

COR20210

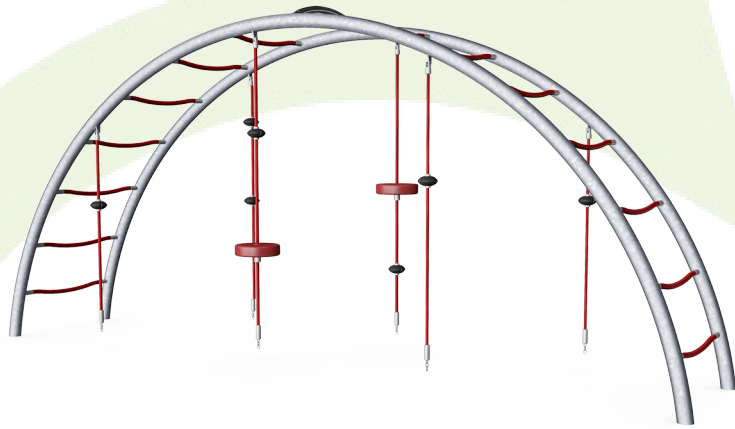

Cradle to Gate A1-A3	Total CO <sub>2</sub> emission	CO <sub>2</sub> e/kg	Recycled materials
	kg CO <sub>2</sub> e	kg CO <sub>2</sub> e/kg	%
<b>COR202101-0301</b>	510.30	3.05	45.20

The overall framework applied for these factors is the Environmental Product Declaration (EPD), which quantifies "environmental information on the life cycle of a product and enable comparisons between products fulfilling the same function" (ISO, 2006). This follows the structure and applies a Life-Cycle Assessment approach to the entire Product stage from raw material through manufacturing (A1-A3))

**Kompan A/S**  
 C.F. Tietgens Boulevard 32C  
 DK-5220 Odense SØ  
 Denmark



## Verification of CO<sub>2</sub> calculation of: Corocord



Data version no. 2023-10-05

The CO<sub>2</sub> calculation and data are in compliance with the principles of a carbon footprint impact according to the GHG protocol (Greenhouse Gas Protocol), Scope 3, cradle to gate related to all individual components in the product category: "Corocord" represented by item no.: COR314011-1101.

(Scope 3 emissions include emission sources in the upstream and downstream value chain).

**Date: 30. October 2023 | Valid until: 30. October 2025**

Verified by:

Julie Marie Vejsgaard Larsen, LCA & EPD Consultant

Verification based on report: Validation of CO<sub>2</sub> calculation of 9 categories of Kompan product line, version 1.0, prepared by: Bureau Veritas HSE, Denmark: Julie M. V. Larsen.

**Publication date: 30. October 2023**

By Bureau Veritas HSE  
 www.bureauveritas.dk  
 +45 7731 1000



# Arch Ladder, 2.0m high

COR20210

\* Max fall height | \*\* Total height | \*\*\* Safety surfacing area

\* Max fall height | \*\* Total height

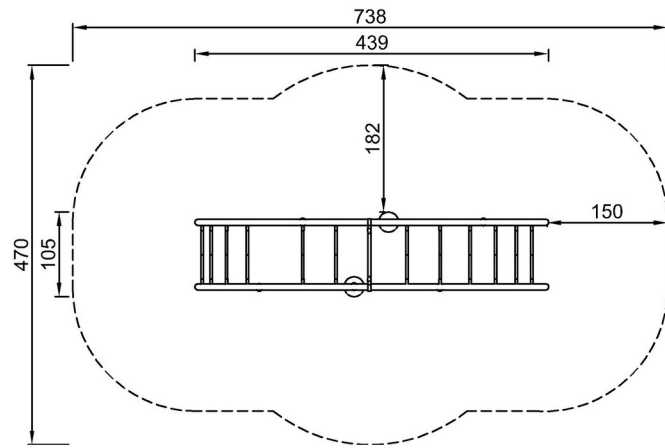

COR202101-xx01  
\*200cm  
\*\*200cm  
\*\*\*28.0m<sup>2</sup>

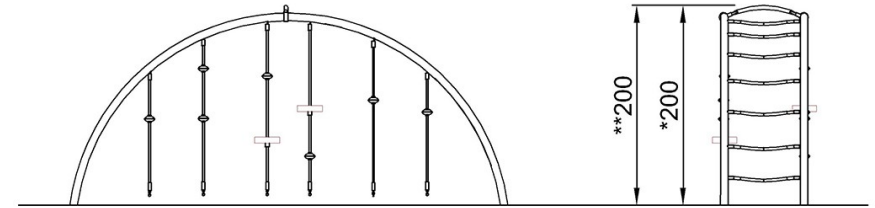

COR202101

[Click to see TOP VIEW](#)

[Click to see SIDE VIEW](#)