

# Jumping Bridge

COR68060

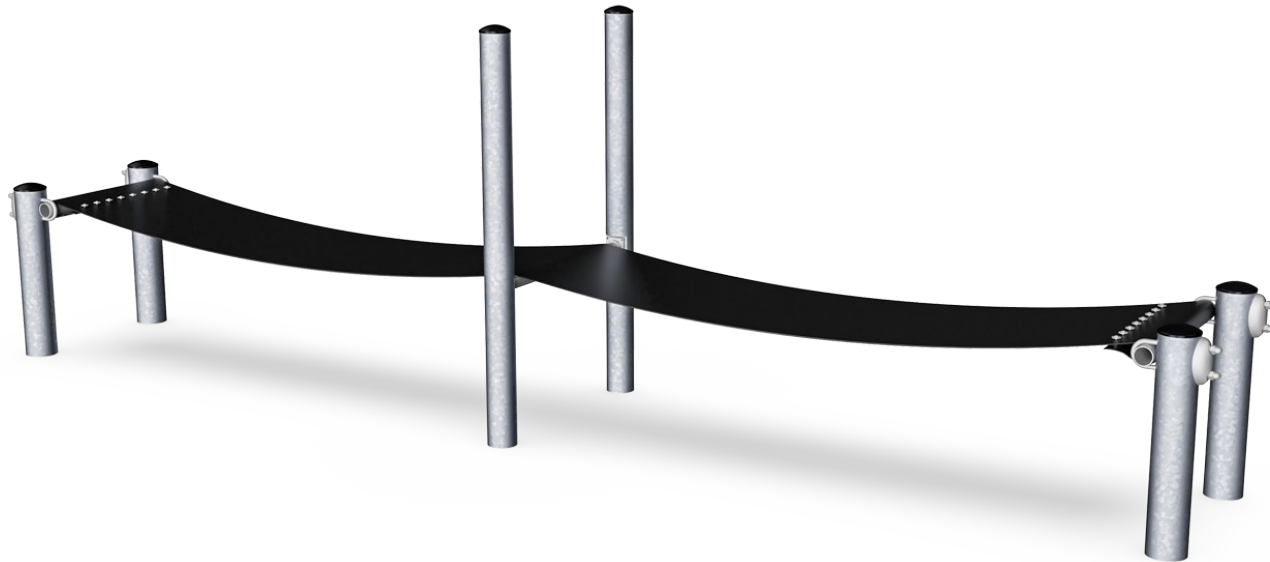

Item no. COR680601-1106	
<b>General Product Information</b>	
Dimensions LxWxH	650x120x195 cm
Age group	5+
Play capacity (users)	12
Colour options	●

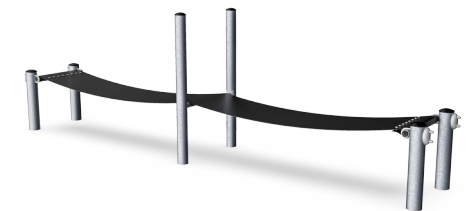
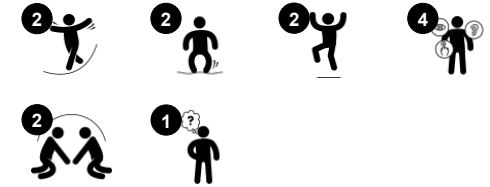

The Jumping Bridge is a responsive social or individual play event that will attract all children time and time again. Bouncing with others is a true challenge: when children find the rhythm of jumping in cooperation, they can catapult each other up in the air, which holds great attraction and evokes many laughs. As well as being lots of fun, the Jumping Bridge helps to develop

important motor skills, such as balance and coordination. Bone density is built in childhood and weight bearing activities such as jumping are perfect in supporting that development. Through playing on the jumping bridge children's cooperation, negotiation and communication skills are challenged.



# Jumping Bridge

COR68060



## Jumping bridge

**Physical:** the wobbly belt bridge trains balance and coordination. When children jump on both modules, they get pushed up in the air training spatial awareness. Jumping builds bone density. **Social-Emotional:** cooperation in timing of movements gets trained intensely to make the Belt Bridge work optimally.

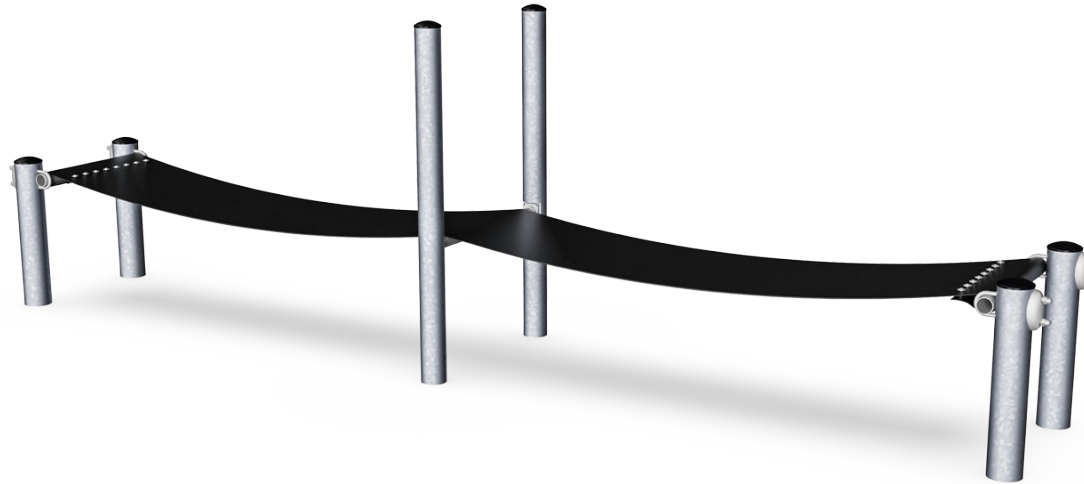

# Jumping Bridge

COR68060



Membrane consisting of friction-proof rubberized material of conveyor belt quality with excellent UV resistance. Tested and compliant with REACH requirements for PAH. Embedded are two layers of galvanised steel wire armoring, making the membrane extremely hardwearing and vandalism resistant. Core and outer layers result in a total thickness of 10mm.



The steel structure are hot dip galvanised inside and outside with lead free zinc. The galvanisation has excellent corrosion resistance in outside environments and requires low maintenance.

Item no. COR680601-1106

### Installation Information

Max. fall height	85 cm
Safety surfacing area	36.4 m <sup>2</sup>
Total installation time	6.0
Excavation volume	4.69 m <sup>3</sup>
Concrete volume	2.98 m <sup>3</sup>
Footing depth (standard)	110 cm
Shipment weight	463 kg
Anchoring options	In-ground ✓

### Warranty Information

Hot dip galvanised steel	Lifetime
Membrane	2 years
Spare parts guaranteed	10 years



# Sustainability Data

COR68060

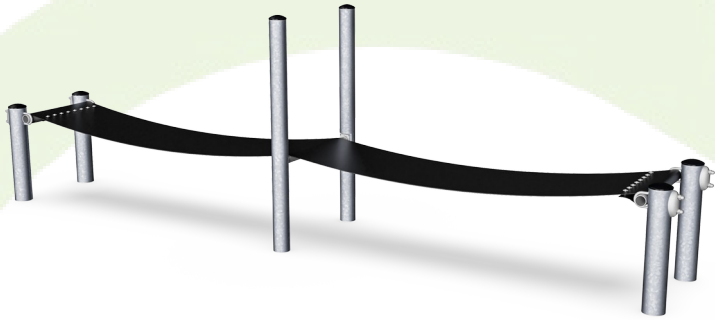

Cradle to Gate A1-A3	Total CO <sub>2</sub> emission	CO <sub>2</sub> e/kg	Recycled materials
	kg CO <sub>2</sub> e	kg CO <sub>2</sub> e/kg	%
<b>COR680601-1106</b>	995.00	3.02	35.05

The overall framework applied for these factors is the Environmental Product Declaration (EPD), which quantifies "environmental information on the life cycle of a product and enable comparisons between products fulfilling the same function" (ISO, 2006). This follows the structure and applies a Life-Cycle Assessment approach to the entire Product stage from raw material through manufacturing (A1-A3))

**Kompan A/S**  
 C.F. Tietgens Boulevard 32C  
 DK-5220 Odense SØ  
 Denmark



## Verification of CO<sub>2</sub> calculation of: Corocord



Data version no. 2023-10-05

The CO<sub>2</sub> calculation and data are in compliance with the principles of a carbon footprint impact according to the GHG protocol (Greenhouse Gas Protocol), Scope 3, cradle to gate related to all individual components in the product category: "Corocord" represented by item no.: COR314011-1101.

(Scope 3 emissions include emission sources in the upstream and downstream value chain).

**Date: 30. October 2023 | Valid until: 30. October 2025**

**Verified by:**

Julie Marie Vejsgaard Larsen, LCA & EPD Consultant

Verification based on report: Validation of CO<sub>2</sub> calculation of 9 categories of Kompan product line, version 1.0, prepared by: Bureau Veritas HSE, Denmark: Julie M. V. Larsen.

**Publication date: 30. October 2023**

**By Bureau Veritas HSE**  
 www.bureauveritas.dk  
 +45 7731 1000



# Jumping Bridge

COR68060

\* Max fall height | \*\* Total height | \*\*\* Safety surfacing area

\* Max fall height | \*\* Total height

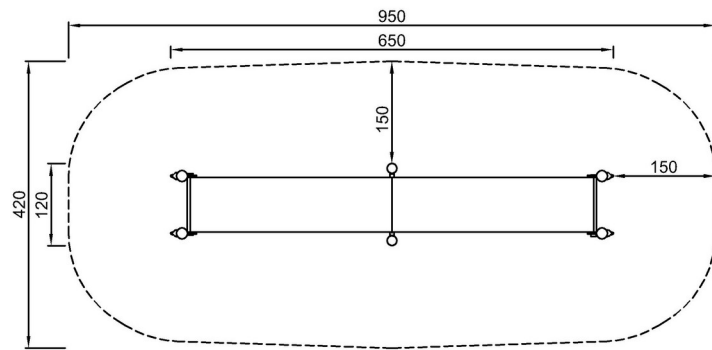

COR680601-xx06  
\*85cm  
\*\*195cm  
\*\*\*36.4m<sup>2</sup>

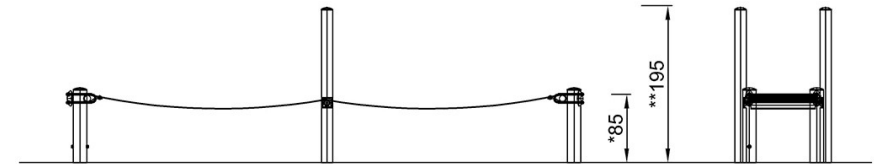

COR680601

[Click to see TOP VIEW](#)

[Click to see SIDE VIEW](#)