

Multi Net

FSW207

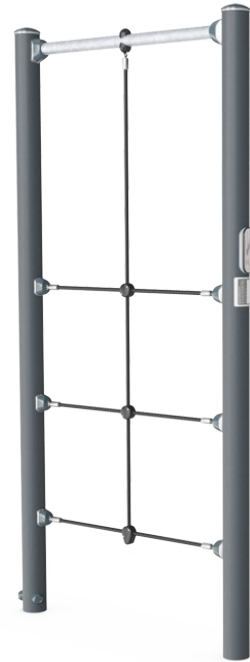

Item no. FSW20700-0000	
General Product Information	
Dimensions LxWxH	119x12x240 cm
Age group	13+
Play capacity (users)	1
Colour options	



See KOMPAN Fit app for more



A climbing structure with an overhead pull up bar that offers support for varying the difficulty levels of own bodyweight exercises. The Multi Net is perfect as a training tool preparing for climbing movements in obstacle and survival runs. The Multi Net has a clear instruction sign showing the basic exercise and a QR code. By clicking on the QR code users can connect to

the KOMPAN fitness App, where they will find multiple exercises and workouts at every level. The Multi Net is standard available in Orange, RAL2010 and Grey, RAL7012. All other RAL colours are available on request. It will always be possible to match the surroundings or colour theme!

Multi Net

FSW207



Post are made of Ø101.6 x 2mm, pre-galvanized carbon steel and powder coated, a great protection to all conditions.



The connectors are made of die-cast aluminium, specially alloyed for the outdoor environments and heavy usage. The screws attaching the connectors are stainless steel and protected by zinc washers.



The ropes are made of UV-stabilised PES with inner steel cable reinforcement. The rope is induction treated in order to create a strong connection between steel and rope which leads to good wear resistance.

Item no. FSW20700-0000

Installation Information

Max. fall height	133 cm
Safety surfacing area	18.5 m ²
Total installation time	3.8
Excavation volume	0.00 m ³
Concrete volume	0.00 m ³
Footing depth (standard)	0 cm
Shipment weight	87 kg
Anchoring options	In-ground ✓ Surface ✓

Warranty Information

Connectors	10 years
Hot dip galvanised steel	Lifetime
Post	10 years
Ropes & nets	10 years
Spare parts guaranteed	10 years



All KOMPAN fitness products are compliant with the ASTM F3101 & EN16630 Outdoor Fitness Standards. Load tests are performed as a static test by adding dynamic factors as well as safety factors to the specified load of 78kg per user. A product intended for 1 user is loaded with 420kg.



The information sign is made of a PA6 (Polyamide) and shows the most relevant exercise and a QR code. When scanned the QR code will link to an animated illustration of the exercise and offers the possibility of downloading the KOMPAN sport & fitness App, which will provide a large amount of exercises and workouts.



KOMPAN fitness products are standard available in Orange, Anthracite Grey, Medium Grey, Dark Grey, Night Sky Blue, Light Blue, Yellow, Red, Black, Moss Green, Lime Green, Medium Green, Sand and Nut Brown. All other RAL colours are available on request. It will always be possible to match the surroundings or colour theme!



Sustainability Data

FSW207



Cradle to Gate A1-A3	Total CO ₂ emission	CO ₂ e/kg	Recycled materials
	kg CO ₂ e	kg CO ₂ e/kg	%
FSW20700-0000	202.40	3.48	46.80

The overall framework applied for these factors is the Environmental Product Declaration (EPD), which quantifies "environmental information on the life cycle of a product and enable comparisons between products fulfilling the same function" (ISO, 2006). This follows the structure and applies a Life-Cycle Assessment approach to the entire Product stage from raw material through manufacturing (A1-A3))

Kompan A/S
C.F. Tietgens Boulevard 32C
DK-5220 Odense SØ
Denmark



Verification of CO₂ calculation of: Fitness



Data version no. 2023-10-05

The CO₂ calculation and data are in compliance with the principles of a carbon footprint impact according to the GHG protocol (Greenhouse Gas Protocol), Scope 3, cradle to gate related to all individual components in the product category: "Fitness" represented by item no.: FAZ10100-0900.

(Scope 3 emissions include emission sources in the upstream and downstream value chain).

Date: 30. October 2023 | Valid until: 30. October 2025

Verified by:

Julie Marie Vejsgaard Larsen, LCA & EPD Consultant

Verification based on report: Validation of CO₂ calculation of 9 categories of Kompan product line, version 1.0, prepared by: Bureau Veritas HSE, Denmark: Julie M. V. Larsen.

Publication date: 30. October 2023

By Bureau Veritas HSE
www.bureauveritas.dk
+45 7731 1000



Multi Net

FSW207

* Max fall height | ** Total height | *** Safety surfacing area

* Max fall height | ** Total height

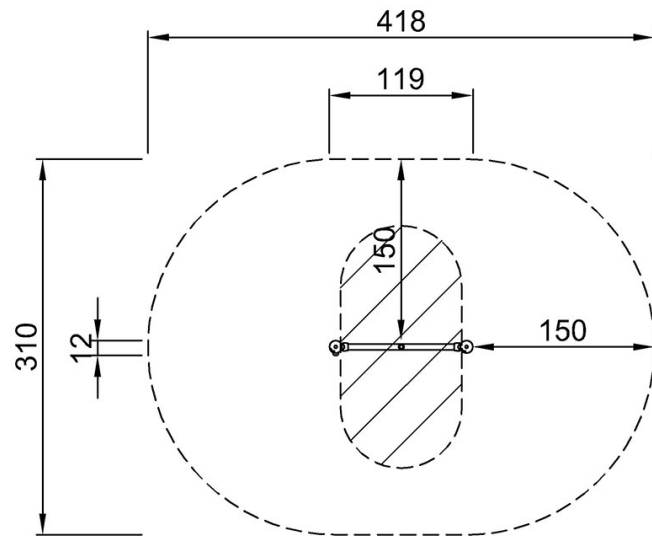

FSW20700
*133cm
**240cm
***18.5m²

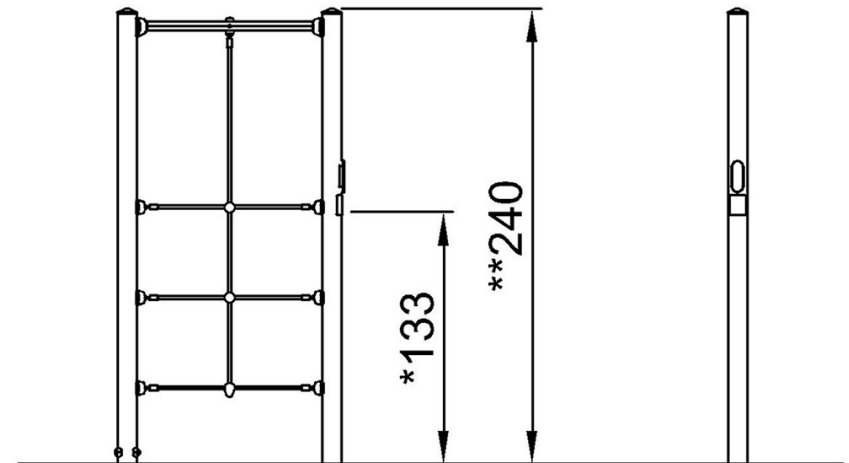

FSW20700

[Click to see TOP VIEW](#)

[Click to see SIDE VIEW](#)