

Pull Up Station

FSW208



Item no. FSW20801-0901	
General Product Information	
Dimensions LxWxH	274x12x240 cm
Age group	13+
Play capacity (users)	2
Colour options	



See KOMPAN Fit app for more



The vertical ladder can be used as a wall, to influence difficulty levels of various exercises such as hand stand push ups, Bulgarian split squats and push ups. Additionally the vertical ladder is perfect for stretching and offers a step up for reaching the pull up bar. The Pull Up Bar is made from solid steel and has a diameter of Ø32 mm. An ideal size for both men and

women to have a good grip.

Pull Up Station

FSW208



Post are made of Ø101.6 x 2mm, pre-galvanized carbon steel and powder coated, a great protection to all conditions.



The connectors are made of die-cast aluminium, specially alloyed for the outdoor environments and heavy usage. The screws attaching the connectors are stainless steel and protected by zinc washers.

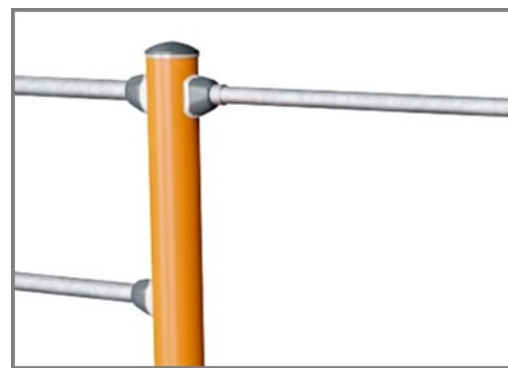

All bars intended for pull ups are made of solid, ø32mm x 138 m, hot dip galvanized, S235JR steel bars. This diameter gives the right grip for everyone.

Item no. FSW20801-0901

Installation Information

Max. fall height	133 cm
Safety surfacing area	21.2 m ²
Total installation time	3.2
Excavation volume	0.38 m ³
Concrete volume	0.21 m ³
Footing depth (standard)	90 cm
Shipment weight	112 kg
Anchoring options	In-ground ✓ Surface ✓

Warranty Information

Connectors	10 years
Hot dip galvanised steel	Lifetime
Post	10 years
Spare parts guaranteed	10 years

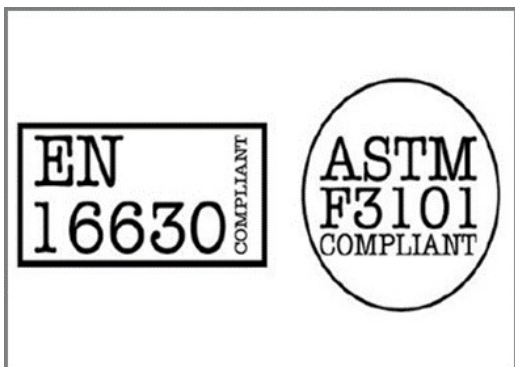

All KOMPAN fitness products are compliant with the ASTM F3101 & EN16630 Outdoor Fitness Standards. Load tests are performed as a static test by adding dynamic factors as well as safety factors to the specified load of 78kg per user. A product intended for 1 user is loaded with 420kg.



The information sign is made of a PA6 (Polyamide) and shows the most relevant exercise and a QR code. When scanned the QR code will link to an animated illustration of the exercise and offers the possibility of downloading the KOMPAN sport & fitness App, which will provide a large amount of exercises and workouts.



The pull up bar is mounted at a height of 233cm with a clean work out space underneath, next to a vertical ladder with 6 horizontal bars. The spaces in between the bars is 38cm.



Sustainability Data

FSW208



Cradle to Gate A1-A3	Total CO ₂ emission	CO ₂ e/kg	Recycled materials
	kg CO ₂ e	kg CO ₂ e/kg	%
FSW20801-0901	242.10	3.48	48.24

The overall framework applied for these factors is the Environmental Product Declaration (EPD), which quantifies "environmental information on the life cycle of a product and enable comparisons between products fulfilling the same function" (ISO, 2006). This follows the structure and applies a Life-Cycle Assessment approach to the entire Product stage from raw material through manufacturing (A1-A3))

Kompan A/S
 C.F. Tietgens Boulevard 32C
 DK-5220 Odense SØ
 Denmark



Verification of CO₂ calculation of: Fitness



Data version no. 2023-10-05

The CO₂ calculation and data are in compliance with the principles of a carbon footprint impact according to the GHG protocol (Greenhouse Gas Protocol), Scope 3, cradle to gate related to all individual components in the product category: "Fitness" represented by item no.: FAZ10100-0900.

(Scope 3 emissions include emission sources in the upstream and downstream value chain).

Date: 30. October 2023 | Valid until: 30. October 2025

Verified by:

Julie Marie Vejsgaard Larsen, LCA & EPD Consultant

Verification based on report: Validation of CO₂ calculation of 9 categories of Kompan product line, version 1.0, prepared by: Bureau Veritas HSE, Denmark: Julie M. V. Larsen.

Publication date: 30. October 2023

By Bureau Veritas HSE
 www.bureauveritas.dk
 +45 7731 1000



Pull Up Station

FSW208

* Max fall height | ** Total height | *** Safety surfacing area

* Max fall height | ** Total height

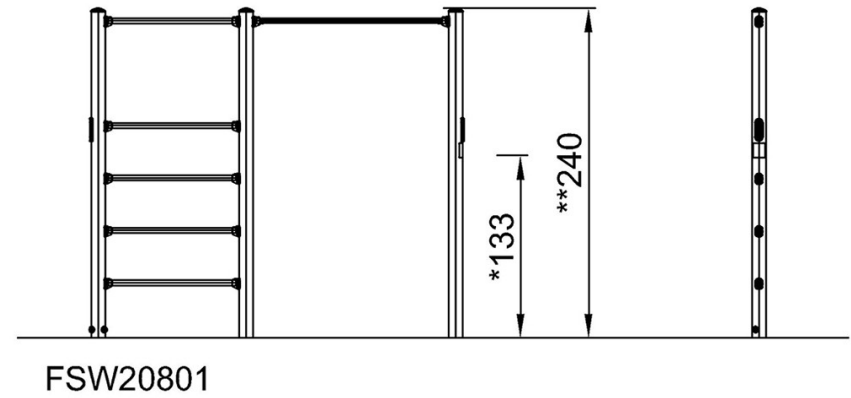
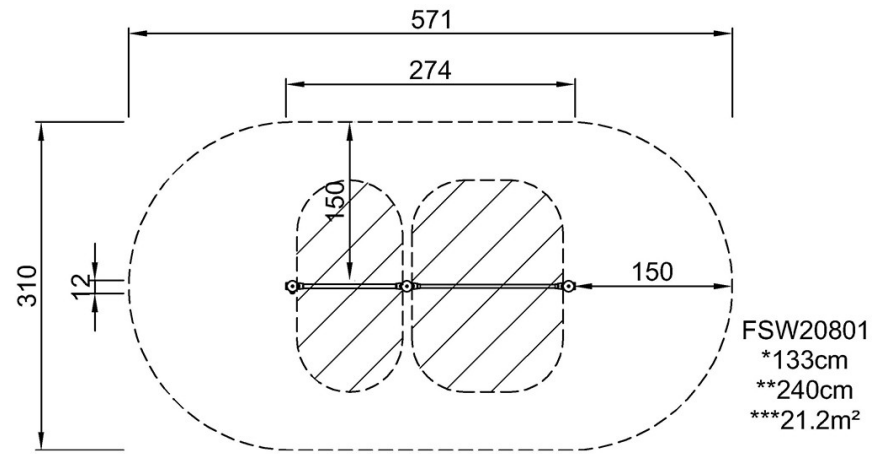

[Click to see TOP VIEW](#)

[Click to see SIDE VIEW](#)