

Embankment Slide, 2.0m high, 1.0m wide

KSL30502

Item no. KSL30502-0401

General Product Information

Dimensions LxWxH	352x104x97 cm
Age group	3+
Play capacity (users)	2
Color options	●

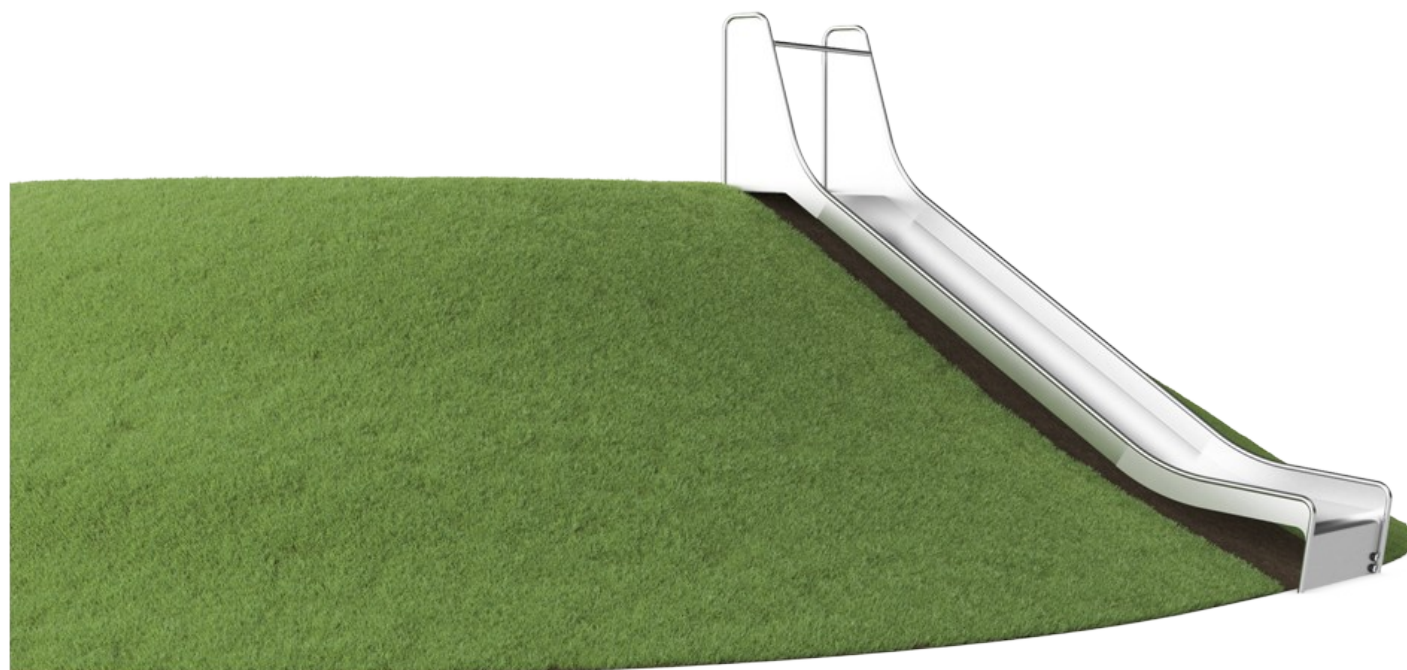

The Embankment Slide is extremely attractive. It makes children loop up hill and slide down again and again. The Embankment Slide will be a main attraction in a playground. Apart from the immense thrill of sliding, the Embankment Slide also supports children in developing important motor skills such as the sense of balance and space. These are important in

managing the world confidently and securely. The repeated loop of sliding and running back up for one more go is great training of cardio and muscle strength. Gaining the courage to go down the tall slide adds a sweet sensation of achievement. This is a social-emotional benefit, which is further enhanced by the cooperation and turn-taking skills that children

going down the slide together.



Embankment Slide, 2.0m high, 1.0m wide

KSL30502



Wide slide

Physical: sliding develops spatial awareness and a sense of balance. Furthermore, the core muscles are trained when sitting upright going down. **Social-Emotional:** invites socializing, supports parent-child and peer-to-peer play. **Cognitive:** young children develop their understanding of space, speed and distances when sliding down quickly.

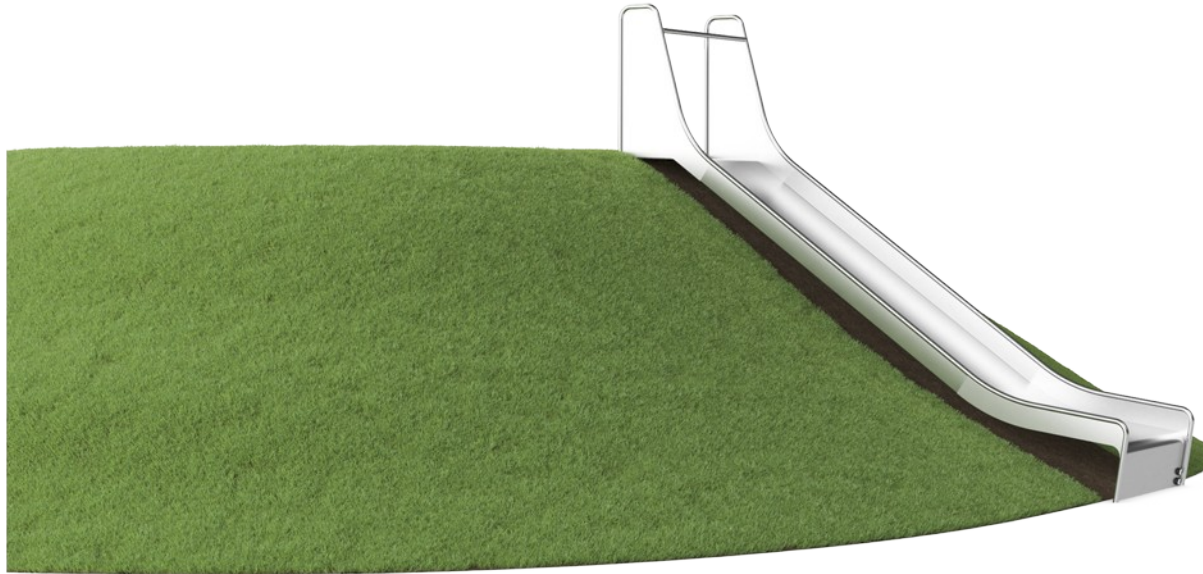

Embankment Slide, 2.0m high, 1.0m wide

KSL30502

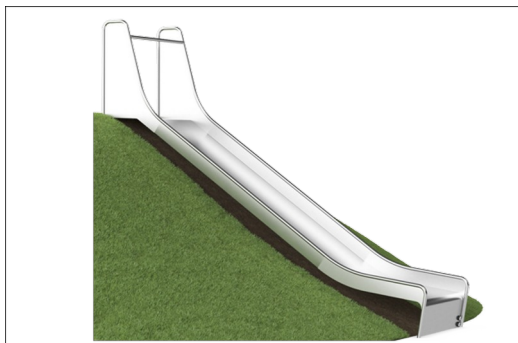

The stainless steel components are made of high quality stainless steel in compliance with global playground standards. The steel is glass blasted after manufacturing to ensure a smooth gliding surface.

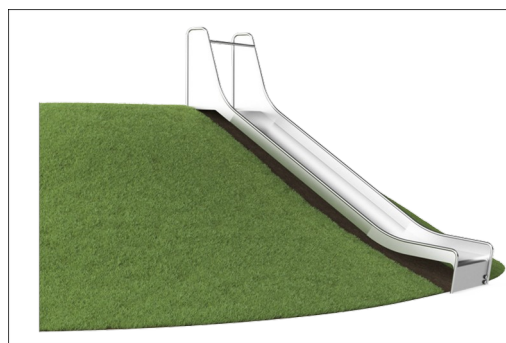

At 35°, the slide is set to the optimum angle to ensure both gliding fun and safety.

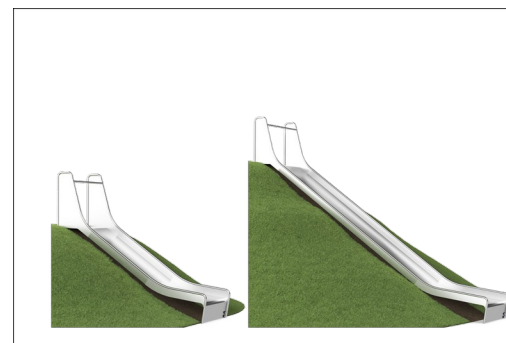

Catering to different terrains, the embankment slides are available in 9 lengths from 1 - 3m.

Item no. KSL30502-0401

Installation Information

Max. fall height	100 cm
Safety surfacing area	20.4 m ²
Total installation time	6.6
Excavation volume	0.83 m ³
Concrete volume	0.53 m ³
Footing depth (standard)	110 cm
Shipment weight	416 kg
Anchoring options	In-ground ✓

Warranty Information

Spare parts guaranteed	10 years
Stainless steel slide	10 years

EN
1176
compliant

Sustainability Data

KSL30502

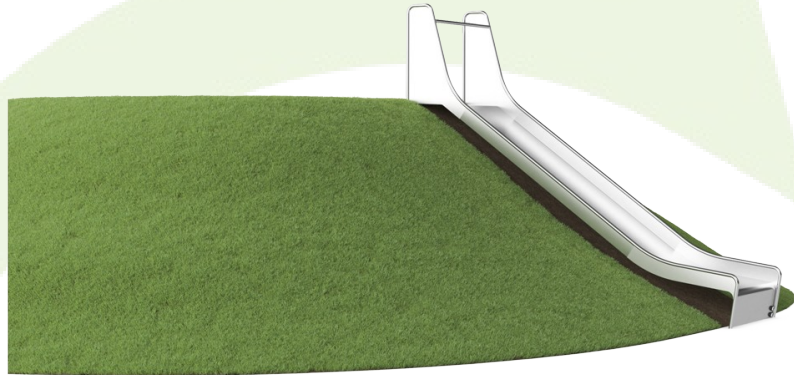

Cradle to Gate A1-A3	Total CO ₂ emission	CO ₂ e/kg	Recycled materials
	kg CO ₂ e	kg CO ₂ e/kg	%
KSL30502-0401	842.04	4.20	49.97

The overall framework applied for these factors is the Environmental Product Declaration (EPD), which quantifies "environmental information on the life cycle of a product and enable comparisons between products fulfilling the same function" (ISO, 2006). This follows the structure and applies a Life-Cycle Assessment approach to the entire Product stage from raw material through manufacturing (A1-A3))

Kompan A/S
 C.F. Tietgens Boulevard 32C
 DK-5220 Odense SØ
 Denmark



Verification of CO₂ calculation of: Freestanding play equipment



Data version no. 2023-10-05

The CO₂ calculation and data are in compliance with the principles of a carbon footprint impact according to the GHG protocol (Greenhouse Gas Protocol), Scope 3, cradle to gate related to all individual components in the product category: "Freestanding play equipment" represented by item no.: GXY916012-3417.

(Scope 3 emissions include emission sources in the upstream and downstream value chain).

Date: 30. October 2023 | Valid until: 30. October 2025

Verified by:

Julie Marie Vejsgaard Larsen, LCA & EPD Consultant

Verification based on report: Validation of CO₂ calculation of 9 categories of Kompan product line, version 1.0, prepared by: Bureau Veritas HSE, Denmark: Julie M. V. Larsen.

Publication date: 30. October 2023

By Bureau Veritas HSE
 www.bureauveritas.dk
 +45 7731 1000



Embankment Slide, 2.0m high, 1.0m wide

KSL30502

* Max fall height | ** Total height | *** Safety surfacing area

* Max fall height | ** Total height

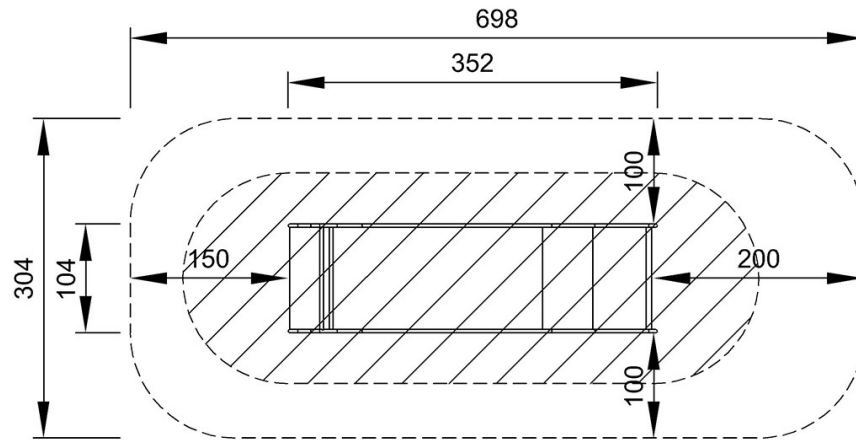

KSL30502
*100cm
**97cm
***20.4m²

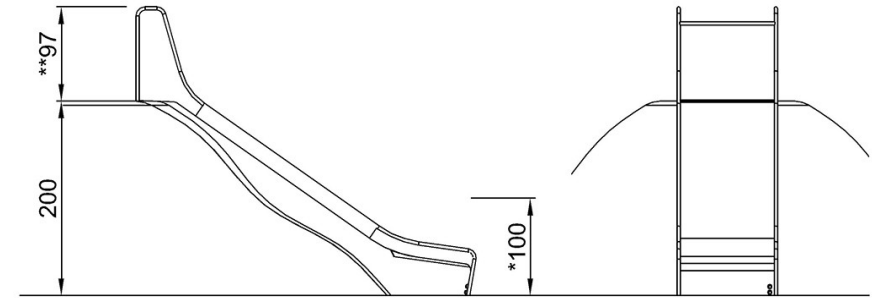

KSL30502

[Click to see TOP VIEW](#)

[Click to see SIDE VIEW](#)