

Dragite with House Membrane

COR10491

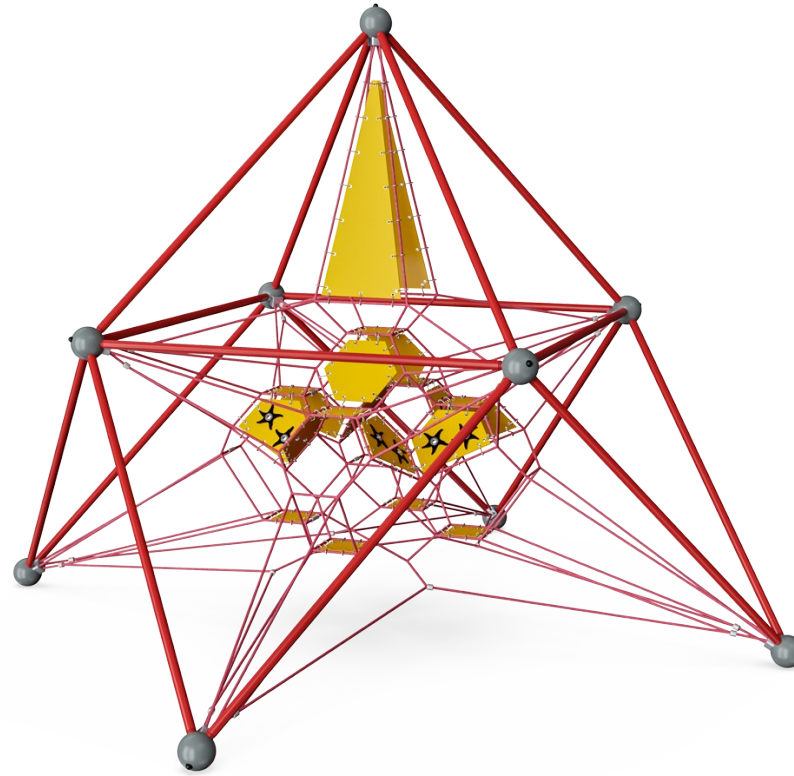

Item no. COR104911-0401	
General Product Information	
Dimensions LxWxH	437x437x436 cm
Age group	3+
Play capacity (users)	28
Color options	

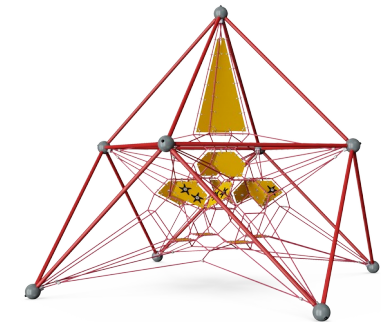
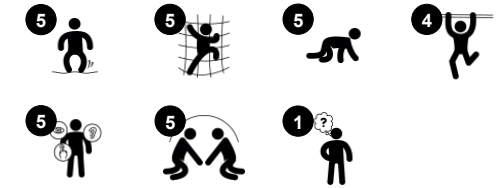

The vibrant colours and responsive, bouncy ropes, nets and membranes of the Dragite attracts children hugely. The varied climbing and meeting options make them want to come back again and again. The lower, yellow membrane squares provide a destination to climb to, bouncy seats that additionally support climbing onwards. This provides motion

support in climbing for younger or less confident climbers, and variation for all. Additionally, the membranes function as meeting and retraction spots in the climbing landscape. The bigger membranes share this function. The main attraction is the bouncy climb up, down and across the Dragite. Concentration is needed when holding tight, as

the ropes are inter-connected and reflect the movements of all climbers, throughout the net. This trains the muscles, cross-body coordination and spatial awareness, important for security in motion.

Dragite with House Membrane

COR10491



Corocord 'S' clamps are used as universal connections in Corocord products. 8mm stainless steel rods with rounded edges are pressed around the ropes with a special hydraulic press, making them the ideal connector: safe, durable and vandalism-proof, all while allowing the typical movement of rope climbing structures.



The aluminium swages of the net are double conical with rounded ends and are as small as safety allows. The overall net design aims at keeping metal parts within the net to an absolute minimum, both in size and number, in order to provide the best possible rope climbing experience.

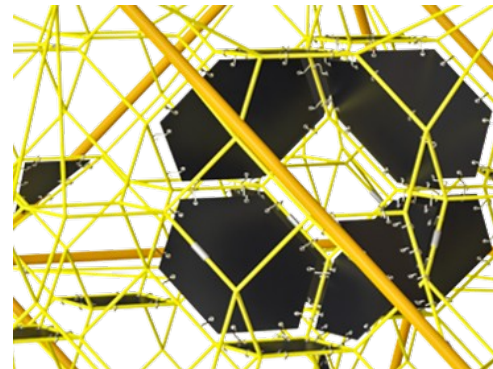

Corocord membranes consist of friction-proof rubberized material of conveyor belt quality with excellent UV resistance. Tested and compliant with REACH requirements for PAH. Embedded is a four-layered armouring made of woven polyester. The armouring and the two surface layers result in a total thickness of 7.5 mm.

Item no. COR104911-0401

Installation Information

Max. fall height	230 cm
Safety surfacing area	57.4 m ²
Total installation time	16.5
Excavation volume	1.76 m ³
Concrete volume	0.98 m ³
Footing depth (standard)	110 cm
Shipment weight	616 kg
Anchoring options	In-ground ✓



The metal parts are made of high quality steel, hot dip galvanised inside and outside with leadfree zinc. On the outside, there is an additional layer of powder coating. This ensures both excellent corrosion resistance and colourful design expression.

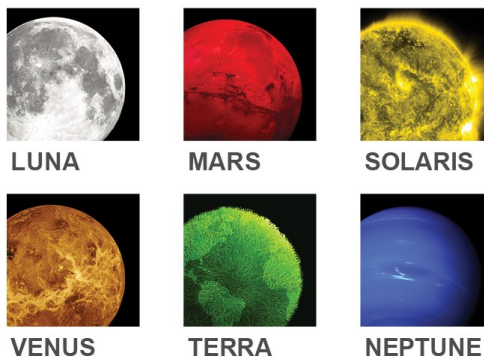

The COROCORD Frame Nets are available in 6 galactic colour themes. The themes draw on bright colours that appeal to children of all ages. Can be changed in the configurator.



Sustainability Data

COR10491

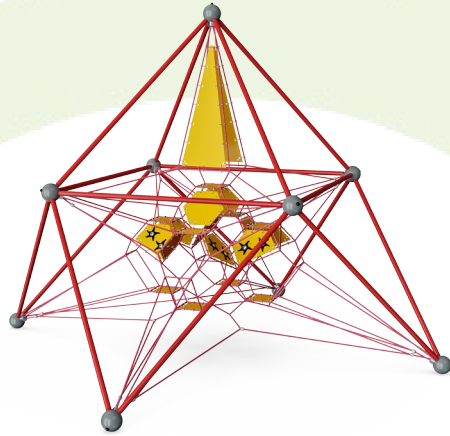

Cradle to Gate A1-A3	Total CO ₂ emission	CO ₂ e/kg	Recycled materials
	kg CO ₂ e	kg CO ₂ e/kg	%
COR104911-0401	1,549.10	3.59	42.20

The overall framework applied for these factors is the Environmental Product Declaration (EPD), which quantifies "environmental information on the life cycle of a product and enable comparisons between products fulfilling the same function" (ISO, 2006). This follows the structure and applies a Life-Cycle Assessment approach to the entire Product stage from raw material through manufacturing (A1-A3))

Kompan A/S
C.F. Tietgens Boulevard 32C
DK-5220 Odense SØ
Denmark



Verification of CO₂ calculation of: Corocord



Data version no. 2023-10-05

The CO₂ calculation and data are in compliance with the principles of a carbon footprint impact according to the GHG protocol (Greenhouse Gas Protocol), Scope 3, cradle to gate related to all individual components in the product category: "Corocord" represented by item no.: COR314011-1101.

(Scope 3 emissions include emission sources in the upstream and downstream value chain).

Date: 30. October 2023 | Valid until: 30. October 2025

Verified by:

Julie Marie Vejsgaard Larsen, LCA & EPD Consultant

Verification based on report: Validation of CO₂ calculation of 9 categories of Kompan product line, version 1.0, prepared by: Bureau Veritas HSE, Denmark: Julie M. V. Larsen.

Publication date: 30. October 2023

By Bureau Veritas HSE
www.bureauveritas.dk
+45 7731 1000



Dragite with House Membrane

COR10491

* Max fall height | ** Total height | *** Safety surfacing area

* Max fall height | ** Total height

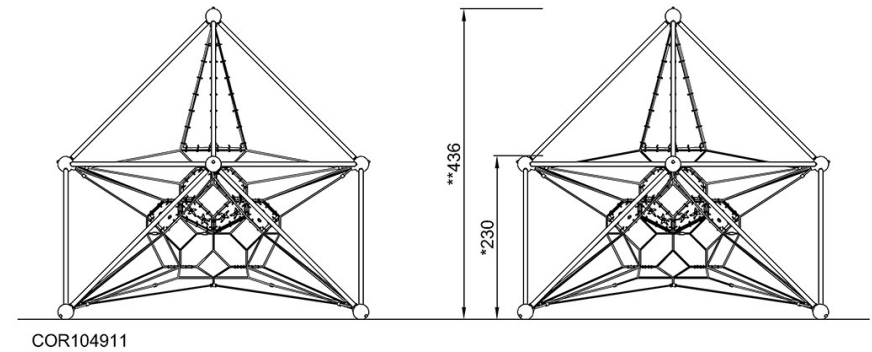
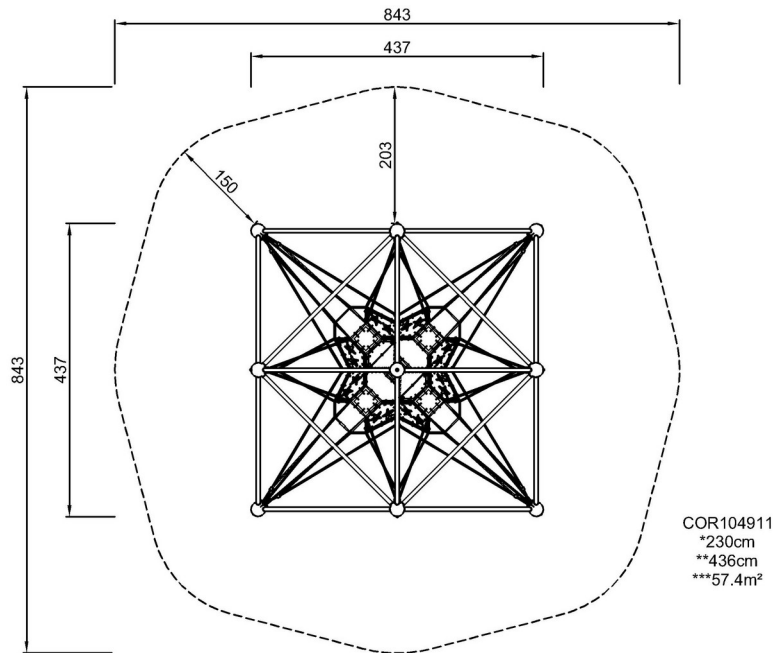

[Click to see TOP VIEW](#)

[Click to see SIDE VIEW](#)