

# Double Tower with Banister Bars

KPL2015



The Double Tower With Banister Bars offers highly attractive play variation to make children play for a long time. The access points have varied difficulty and thrill levels, as well as the egresses: The fireman's pole is for more seasoned players, training risk-taking and proprioception. For children who want to play it safer, the slide section allows for high-paced,

cardio and balance packed looping. The bridge invites thrilling balance training with friends, encouraging cooperation and consideration of others. It also trains the senses of balance and space, important for managing the world securely. On ground level a play panel creates a gathering corner to meet with friends. The balance of more thrilling and more well-known

play activities makes this a versatile challenge for most children. They will meet, turn-take and cooperate in play, building up important socio-emotional skills and friendships.

产品编号 KPL201511-0902	
产品信息概览	
长宽高尺寸	387x441x372 cm
适用年龄段	6+
容纳人数	14
颜色选择	

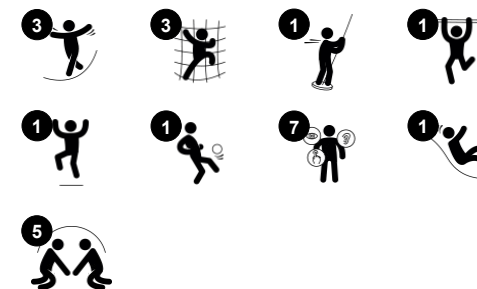

# Double Tower with Banister Bars

KPL2015



## Net bridge, inclined

**身体素质：**walking the open net up or downwards develops balance, spatial awareness and cross coordination. **社交情感：**与儿童互动、社交，培养合作意识与同理心。



## Climbing pole

**身体素质：**训练交叉协调和肌肉力量。 **社交情感：**培养轮流和合作意识。

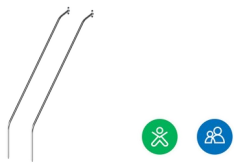

## Banister bars

**身体素质：**跳下来时，身体的协调性、手臂和核心肌肉都会得到发展。落地运动可增强骨密度，为童年生活做好准备。 **社交情感：**训练轮流意识和风险意识。



## Climbing wall

**身体素质：**培养儿童攀爬时的交叉协调能力、手眼协调能力和肌肉力量。 **社交情感：**双面攀爬活动需要合作意识。



## 滑梯

**身体素质：**玩滑梯可以培养空间感和平衡感。此外，在直立向下坐时，核心肌肉也能得到锻炼。 **社交情感：**轮流玩耍时可激发同理心。



## Maze panel

**社交情感：**与朋友一起探索迷宫时可以进行交流与合作。 **认知能力：**在回忆迷宫路线时提高记忆能力

# Double Tower with Banister Bars

KPL2015



19 毫米 EcoCore™ 面板。EcoCore™ 是一种高度耐用、环保的材料，不仅在使用后可回收利用，而且还包含由 100 % 食品包装可循环材料制成的芯。



主塔的支柱或松木或铝都配备了热浸镀锌钢底座。钢底座将柱子从地面抬高 20mm，以避免与堆焊材料接触。

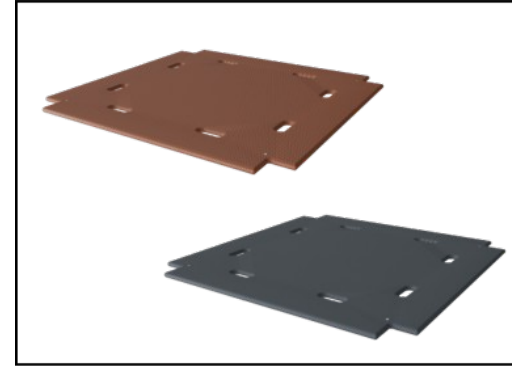

地板和面板有两种类型的材料：厚度为 21.5mm 的防水胶合板，由松木和赤杨木制成，两侧均带有防滑膜。高压层压板 HPL 厚度 17.8mm，根据 EN 438-6 具有防滑表面纹理。

产品编号 KPL201511-0902

## 安装信息

最大跌落高度	209 cm
安全面积	42.2 m <sup>2</sup>
安装总时长	12.5
开挖量	1.43 m <sup>3</sup>
混凝土使用量	0.50 m <sup>3</sup>
标准入地深度	90 cm
运输重量	414 kg
固定选项	入地 ✓ 地表 ✓

## 质保信息

铝	15 年
EcoCore HDPE	终身质保
松木	10 年
绳网	10 年
承保零部件	10 年

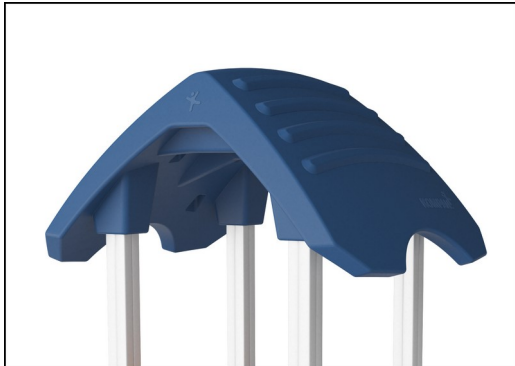

大型空心部件由 100 % 可回收的 PE 制成。所展示的屋顶是一体成型的，最小壁厚为 5.5mm，以确保在全球所有气候条件下的高耐久性。

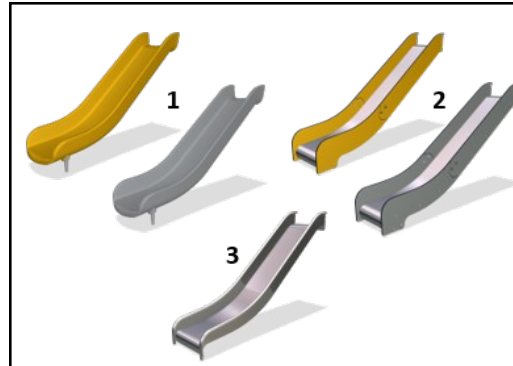

滑梯有三种不同的材料：模制在 PE 滑轨上，EcoCore™ 组合侧面和 t = 2mm 的不锈钢滑轨。全不锈钢 AISI304 t = 2mm。



攀爬网由防紫外线的聚丙烯绳和内部的钢缆构成强化。对钢丝绳进行了感应处理，使其在钢和钢丝绳之间得到最大程度的固定，从而具有很好的耐磨性和抗撕裂性。所有的绳接头都是由 100% 可回收的 PA 材料制成。



# Sustainability Data

KPL2015



## 从原材料到成品

CO<sub>2</sub> 排放总量

kg CO<sub>2</sub>e

CO<sub>2</sub> 排放量 / 千克

kg CO<sub>2</sub>e/kg

回收的原料

%

KPL201511-0902

523.75

1.61

34.18

这些因素采用的总体框架为环保产品声明 (EPD), 该声明可量化“产品生命周期的环保信息, 并对相同功能的产品进行对比” (ISO, 2006)。在遵循该框架的同时, 对从原材料到制造的整个产品阶段 (A1-A3) 应用生命周期评估法。

## Kompan A/S

C.F. Tietgens Boulevard 32C  
DK-5220 Odense SØ  
Denmark

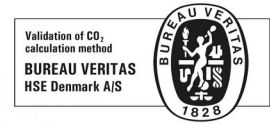

## Verification of CO<sub>2</sub> calculation of: Play systems



Data version no. 2023-10-05

The CO<sub>2</sub> calculation and data are in compliance with the principles of a carbon footprint impact according to the GHG protocol (Greenhouse Gas Protocol), Scope 3, cradle to gate related to all individual components in the product category: "Play systems" represented by item no.: PCM200321-0950.

(Scope 3 emissions include emission sources in the upstream and downstream value chain).

**Date: 30. October 2023 | Valid until: 30. October 2025**

Verified by:

Julie Marie Vejsgaard Larsen, LCA & EPD Consultant

Verification based on report: Validation of CO<sub>2</sub> calculation of 9 categories of Kompan product line, version 1.0, prepared by: Bureau Veritas HSE, Denmark: Julie M. V. Larsen.

**Publication date: 30. October 2023**

By Bureau Veritas HSE  
www.bureauveritas.dk  
+45 7731 1000



# Double Tower with Banister Bars

KPL2015

最大跌落高度 | 总高度 | 安全区域

最大跌落高度 | 总高度

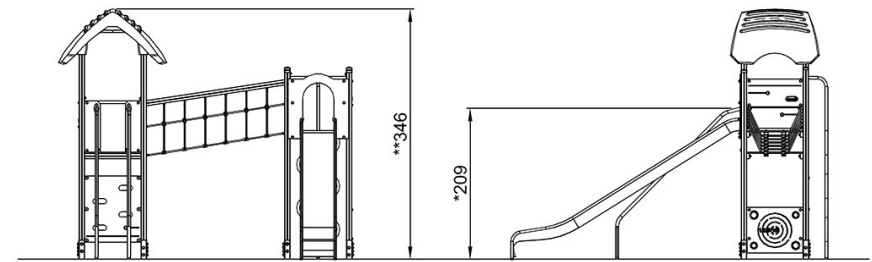
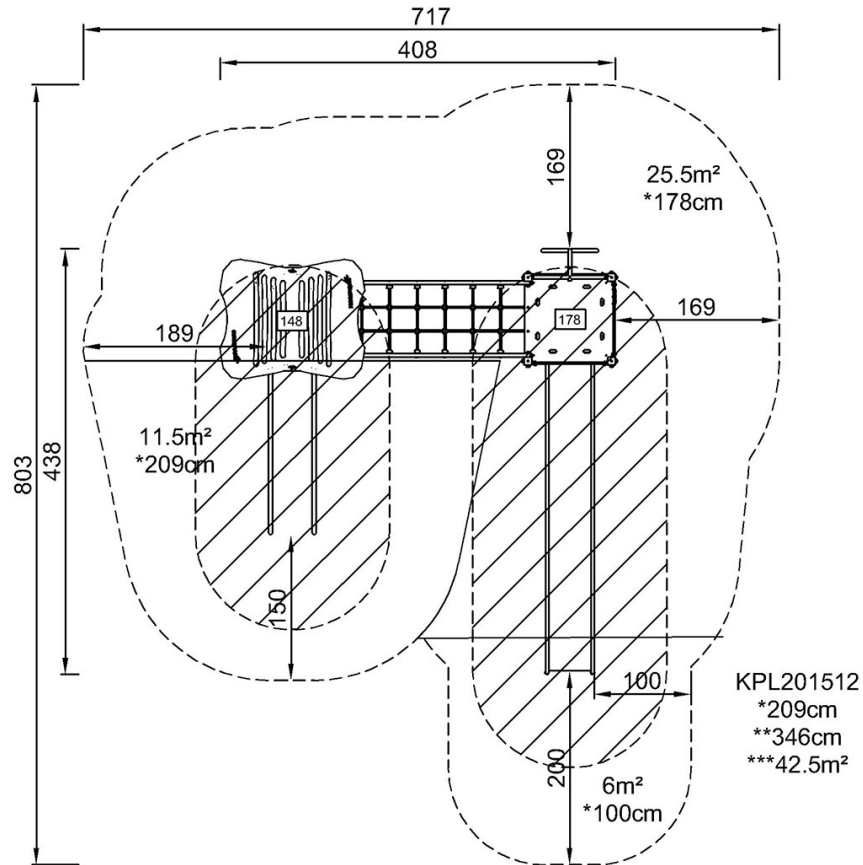

KPL201512

[点击查看俯视图](#)

[点击查看侧面图](#)