

Explorer Arch

CRP800501

Item no. CRP800501-0904

General Product Information

Dimensions LxWxH	617x108x310 cm
Age group	5+
Play capacity (users)	12
Color options	

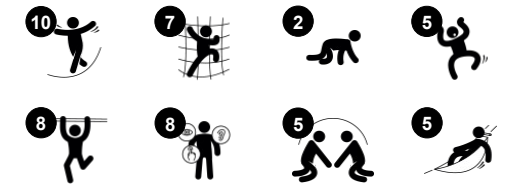
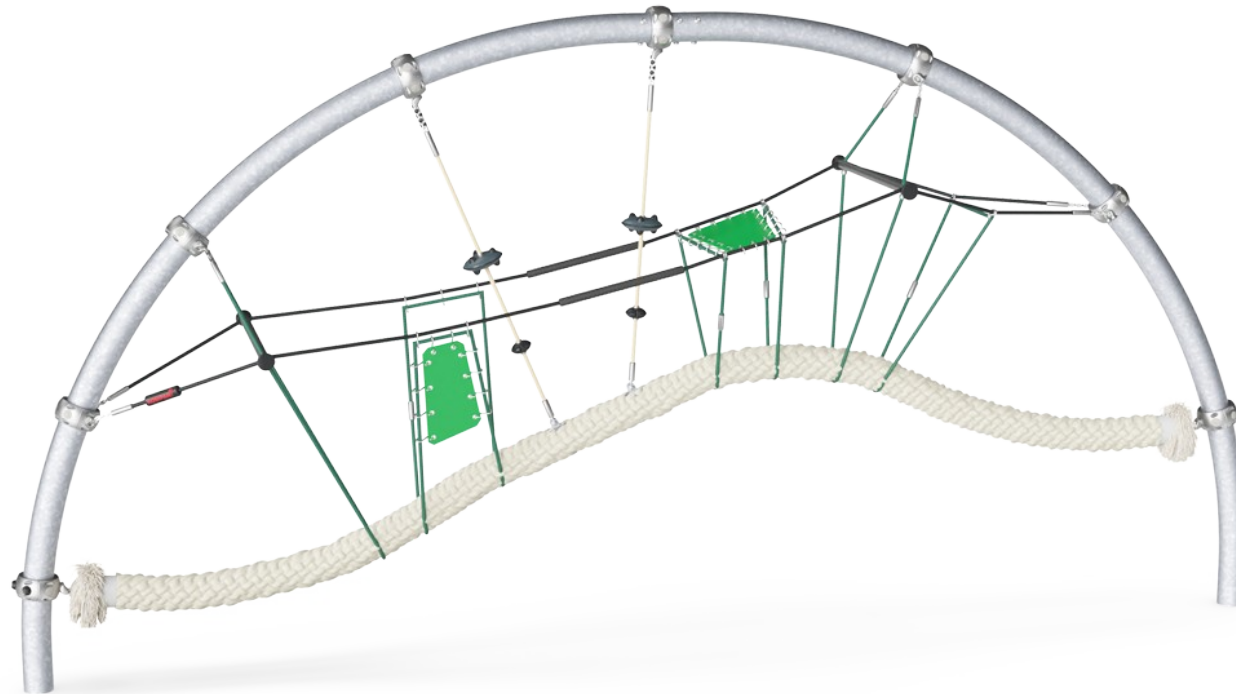

The Ocean Arch is an intriguing structure that will attract children to play on it. Due to the varied, bouncing and slanting ropes and hammocks, children will stay for a long time, trying it all out. The transparency of the multiple levels supports social interaction throughout the structure. The membrane and net hammocks offer destination meeting points for

smaller or bigger groups of children. The swaying adds to the training of balance and spatial awareness which are fundamental for judging distances, e.g. in the street. Climbing the Ocean Arch helps with the development of cross-coordination skills, which help with the development of your left and right brain half. The many tactile details and varied materials

are excellent areas for sensory play. The Ocean Arch ticks all the play value boxes.



Explorer Arch

CRP800501



The chain/ropes are attached to the Coconut rope by KOMPAN swivel bushings made of stainless steel with bronze bearings. The swivels have an outside cover of black PUR. The usage of side mounted swivels provides frictionless movement, eliminates fingers and feet entrapments and enlarges the standing surface on top of the rope.

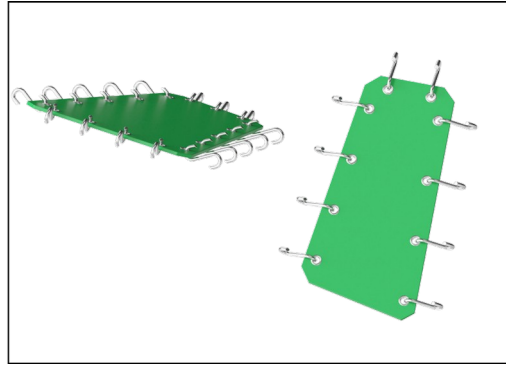

Corocord membranes consist of friction-proof rubberized material of conveyor belt quality with excellent UV resistance. Tested and compliant with REACH requirements for PAH. Embedded is a four-layered armouring made of woven polyester. The armouring and the two surface layers result in a total thickness of 8 mm.

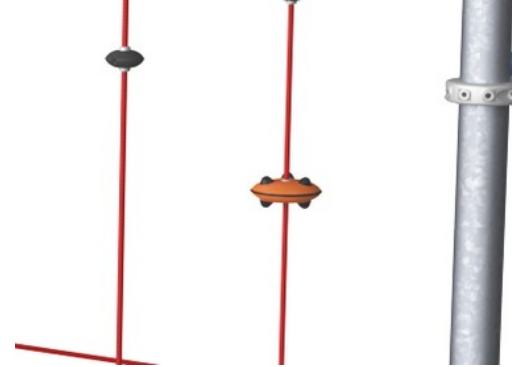

Play activities like UFOs are made of injection moulded high quality PA6. PA6 has good wearing and impact strength.

Item no. CRP800501-0904	
Installation Information	
Max. fall height	225 cm
Safety surfacing area	37.4 m ²
Total installation time	12.4
Excavation volume	4.05 m ³
Concrete volume	2.30 m ³
Footing depth (standard)	90 cm
Shipment weight	590 kg
Anchoring options	

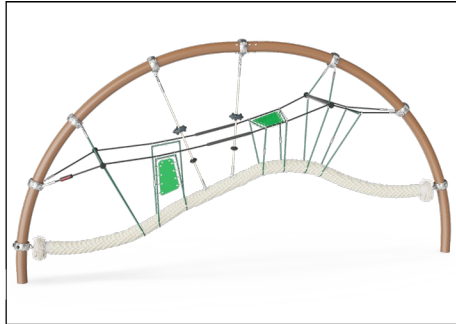

The banded arches are holding the tensioned net structure without additional disturbing fasteners. The arches are produced from high quality stainless steel to allow movement of the net on the surface of the steel arches. The surface is treated to make it shiny.



Corocord 'S' clamps are used as universal connections in Corocord products. 8mm stainless steel rods with rounded edges are pressed around the ropes with a special hydraulic press, making them the ideal connector: safe, durable and vandalism-proof, all while allowing the typical movement of rope play structures.



Corocord smart clamps are carefully designed in every detail to ensure superior flexibility in high quality aluminum material. The smart clamps are attached around the posts with four steel bolts. Not used attachment points are closed with PA caps.

**EN
1176**
compliant

Sustainability Data

CRP800501

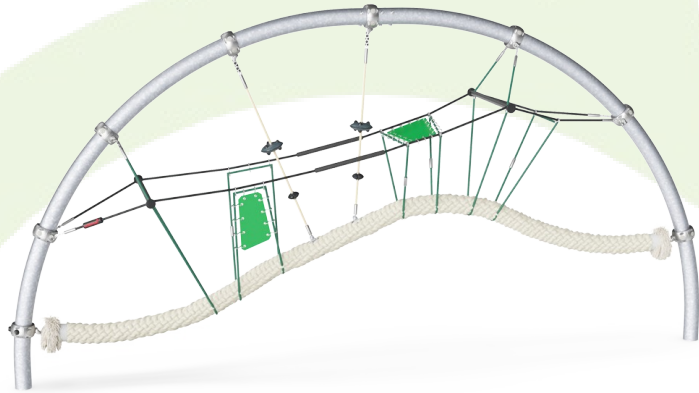

Cradle to Gate A1-A3	Total CO ₂ emission	CO ₂ e/kg	Recycled materials
	kg CO ₂ e	kg CO ₂ e/kg	%
CRP800501-0904	1,178.30	3.88	44.40

The overall framework applied for these factors is the Environmental Product Declaration (EPD), which quantifies "environmental information on the life cycle of a product and enable comparisons between products fulfilling the same function" (ISO, 2006). This follows the structure and applies a Life-Cycle Assessment approach to the entire Product stage from raw material through manufacturing (A1-A3))

Kompan A/S
 C.F. Tietgens Boulevard 32C
 DK-5220 Odense SØ
 Denmark



Verification of CO₂ calculation of: Corocord



Data version no. 2023-10-05

The CO₂ calculation and data are in compliance with the principles of a carbon footprint impact according to the GHG protocol (Greenhouse Gas Protocol), Scope 3, cradle to gate related to all individual components in the product category: "Corocord" represented by item no.: COR314011-1101.

(Scope 3 emissions include emission sources in the upstream and downstream value chain).

Date: 30. October 2023 | Valid until: 30. October 2025

Verified by:

Julie Marie Vejsgaard Larsen, LCA & EPD Consultant

Verification based on report: Validation of CO₂ calculation of 9 categories of Kompan product line, version 1.0, prepared by: Bureau Veritas HSE, Denmark: Julie M. V. Larsen.

Publication date: 30. October 2023

By Bureau Veritas HSE
 www.bureauveritas.dk
 +45 7731 1000



Explorer Arch

CRP800501

* Max fall height | ** Total height | *** Safety surfacing area

* Max fall height | ** Total height

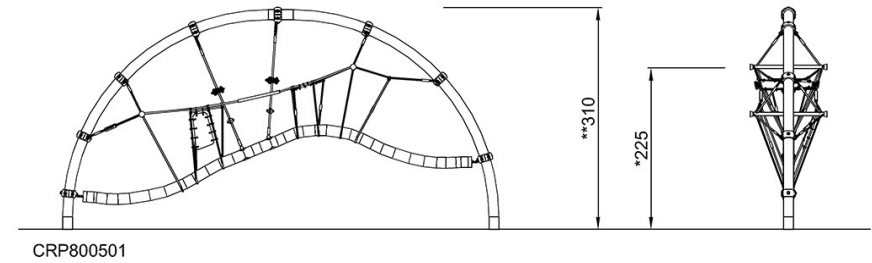
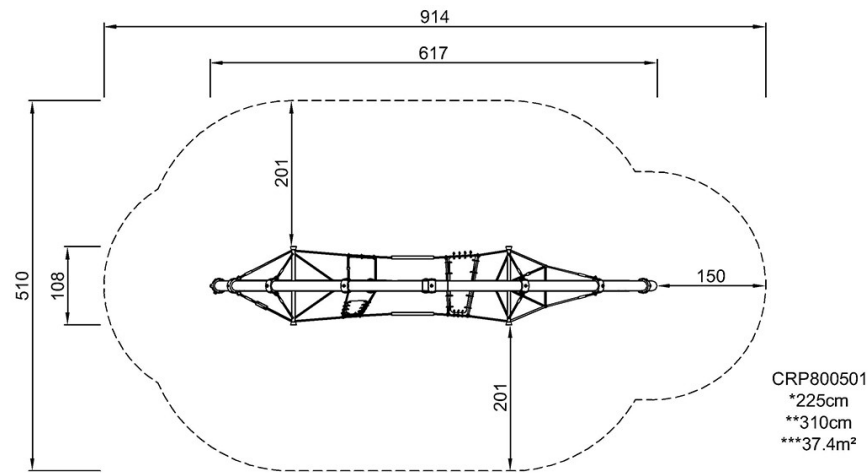

[Click to see TOP VIEW](#)

[Click to see SIDE VIEW](#)