

Langur Trail

CRP251901

Item no. CRP251901-0901

General Product Information

Dimensions LxWxH	2172x743x307 cm
Age group	6+
Play capacity (users)	47
Color options	

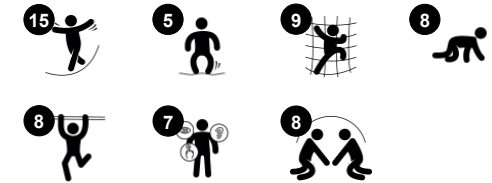
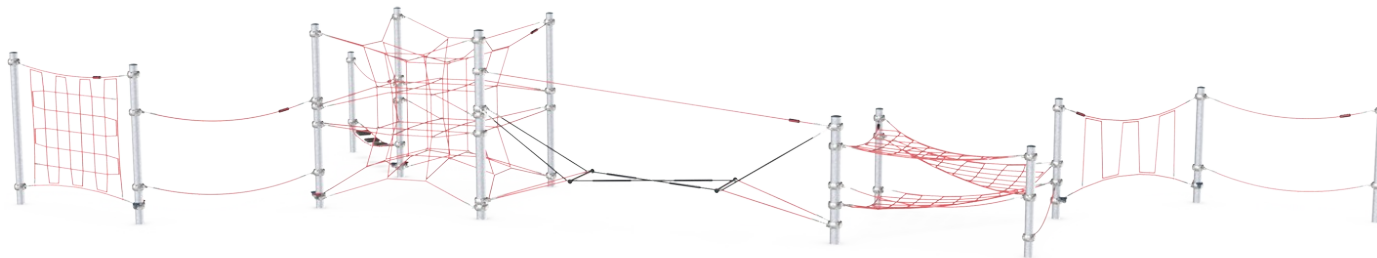

The Langur Trail with its linear layout provides highly attractive challenges for children, again and again. Lots of varied, responsive, swaying and bouncing nets and ropes take concentrated movement to cross, adjusting for different grips and rhythms of climbing. This trains agility, balance and coordination skills. These motor skills are fundamental for body

confidence and eventually concentrating and sitting still on a chair. Apart from being great fun, the Horizontal nets, the Cube net and Shaky Pods allow children to take a break and socialize or cooperate when combining breaks and movement through the structure. This develops important social-emotional skills such as turn-taking, empathy and self-regulation.

The bouncy, swaying range of challenging play makes the Langur Trail a highly attractive play unit that supports children's development through fun play.



Langur Trail

CRP251901

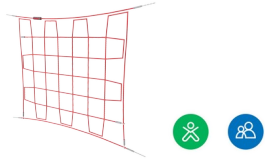

Vertical climbing net

Physical: children develop cross-body coordination when climbing. Arm, leg and core muscles are strengthened. These are important for posture control and also sitting still. **Social-Emotional:** the meshes allow for more children to sit together and talk.

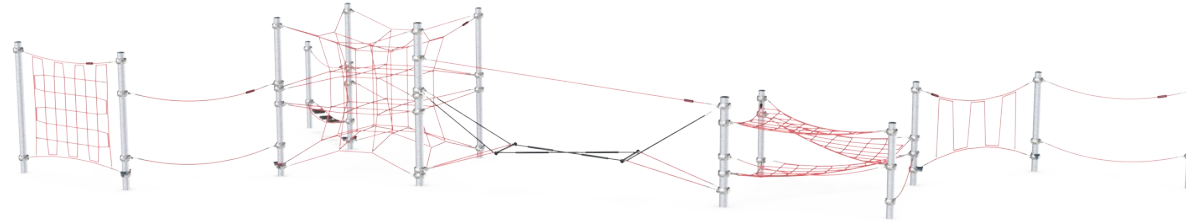

Tightrope

Physical: children train cross-body coordination and muscle strength. The big meshes allow for climbing and crawling through, training proprioception and spatial awareness. **Social-Emotional:** the big meshes allow for more children being seated together, sharing.



Balancing ropes

Physical: holding onto the swaying upper rope when balancing on the swaying lower rope makes excellent training of the sense of balance and trunk muscles. These abilities are fundamental for being able to sit still. **Social-Emotional:** there is room for more than one and cooperating with friends on walking over the swaying ropes is a true cooperation task that requires teamwork and tolerance.



Shaky pods rope

Physical: sense of balance and space, and training of posture. Important for being able to sit still. **Social-Emotional:** cooperation, turn-taking and friendly competition on the plates.



Cube net

Physical: agility, balance and coordination as well as spatial awareness are supported when bouncing, climbing and sitting in the net. Children train their arm, leg and core muscle strength. **Social-Emotional:** great meeting point that invites socializing and sharing.

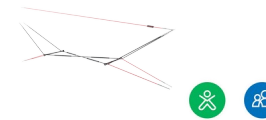

Swaying seesaw

Physical: the Swaying Seesaw is a challenging training of balance, spatial awareness, and timing: to bounce each other up and down is a balance quest that takes handholds, hence the supportive ropes. The skills trained here are fundamental for instance for navigating traffic safely. **Social-Emotional:** passing others on the bridge intensely trains cooperation and communication skills.



Spix's Trail

Physical: children develop cross-body coordination and sense of balance when balancing on and climbing the nets. **Social-Emotional:** the big meshes allow for more children being seated or lying together.

Langur Trail

CRP251901



Ropes of UV-stabilized PES rope strands with inner steel cable reinforcement. The polyester yarn is made from +95% post-consumer materials and is inductively melted onto each strand.



Corocord 'S' clamps are used as universal connections in Corocord products. 8mm stainless steel rods with rounded edges are pressed around the ropes with a special hydraulic press, making them the ideal connector: safe, durable and vandalism-proof, all while allowing the typical movement of rope play structures.



Corocord smart clamps are carefully designed in every detail to ensure superior flexibility in high quality aluminum material. The smart clamps are attached around the posts with four steel bolts. Not used attachment points are closed with PA caps.

Item no. CRP251901-0901	
Installation Information	
Max. fall height	290 cm
Safety surfacing area	147.3 m ²
Total installation time	37.2
Excavation volume	24.61 m ³
Concrete volume	13.67 m ³
Footing depth (standard)	90 cm
Shipment weight	1,766 kg
Anchoring options	Surface ✓ In-ground ✓

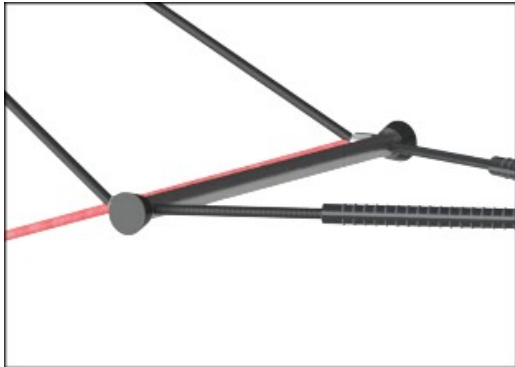

Decorative elements (fish-shaped) are made of stainless steel.



Panels of 19mm EcoCore™. EcoCore™ is a highly durable, eco friendly material, which is not only recyclable after use, but also consists of material produced from +95% recycled post consumer material from food packing waste.

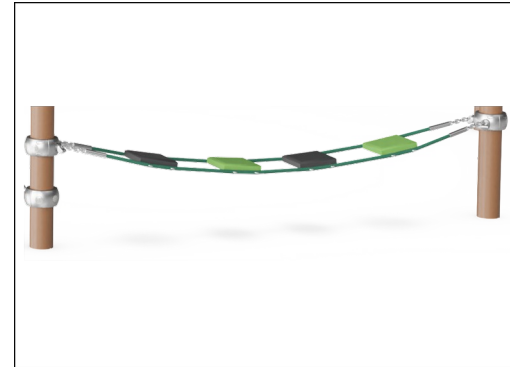

Balance pads are made of EPDM rubber. Material is UV stabilised.



Sustainability Data

CRP251901

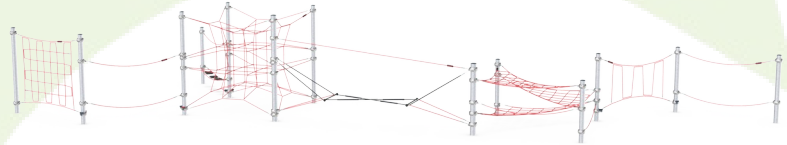

Cradle to Gate A1-A3	Total CO ₂ emission	CO ₂ e/kg	Recycled materials
	kg CO ₂ e	kg CO ₂ e/kg	%
CRP251901-0901	4,069.28	3.57	44.94

The overall framework applied for these factors is the Environmental Product Declaration (EPD), which quantifies "environmental information on the life cycle of a product and enable comparisons between products fulfilling the same function" (ISO, 2006). This follows the structure and applies a Life-Cycle Assessment approach to the entire Product stage from raw material through manufacturing (A1-A3))

Kompan A/S
 C.F. Tietgens Boulevard 32C
 DK-5220 Odense SØ
 Denmark



Verification of CO₂ calculation of: Corocord

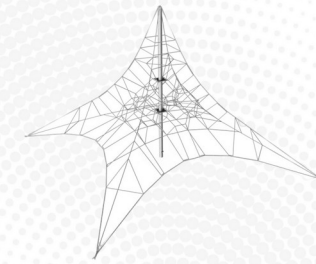

Data version no. 2023-10-05

The CO₂ calculation and data are in compliance with the principles of a carbon footprint impact according to the GHG protocol (Greenhouse Gas Protocol), Scope 3, cradle to gate related to all individual components in the product category: "Corocord" represented by item no.: COR314011-1101.

(Scope 3 emissions include emission sources in the upstream and downstream value chain).

Date: 30. October 2023 | Valid until: 30. October 2025

Verified by:

Julie Marie Vejsgaard Larsen, LCA & EPD Consultant

Verification based on report: Validation of CO₂ calculation of 9 categories of Kompan product line, version 1.0, prepared by: Bureau Veritas HSE, Denmark: Julie M. V. Larsen.

Publication date: 30. October 2023

By Bureau Veritas HSE
 www.bureauveritas.dk
 +45 7731 1000



Langur Trail

CRP251901

* Max fall height | ** Total height | *** Safety surfacing area

* Max fall height | ** Total height

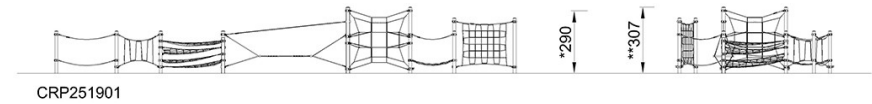
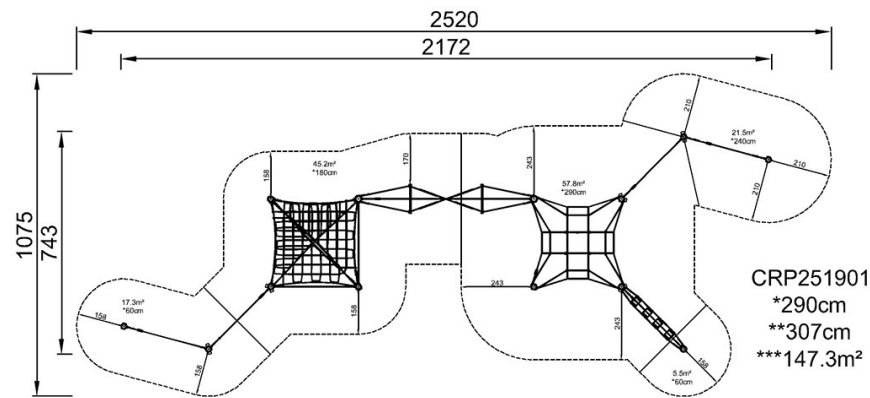

[Click to see TOP VIEW](#)

[Click to see SIDE VIEW](#)