

Stainless Steel Slide, High

KPL304

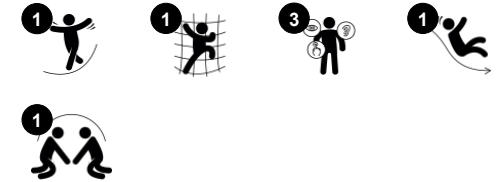

Item no. KPL304-0601	
General Product Information	
Dimensions LxWxH	54x377x277 cm
Age group	4+
Play capacity (users)	3
Colour options	



The Stainless Steel Slide is a playground classic. It is fun play and children can't wait to try it out again and again. Looping the stair and the slide, apart from being fun, is great cardio training. Furthermore, children train their turn-taking skills and their empathy when waiting for others, who may be less courageous or fast. When children slide, they train their core

muscles, sitting upright while sliding down. This stimulates trunk stability, important for avoiding back and neck pains – a growing problem in children due to increasingly sedentary lifestyles. It additionally trains the sense of balance, fundamental for other motor skills. Climbing up the ladder to the Stainless Steel Slide, children train their cross-coordination. The

training of cross-coordination is important for the cooperation of left and right brain side. This cooperation is used for instance when children read. A great activity which is fun and stimulates basic physical skills.

Stainless Steel Slide, High

KPL304



Pipe ladder

Physical: cross coordination and eye-hand coordination are supported when children climb the ladder. The climbing also supports leg and arm muscles. **Social-Emotional:** learning about turn taking and cooperation.



Slide

Physical: sliding develops spatial awareness and a sense of balance. Furthermore, the core muscles are trained when sitting upright going down. **Social-Emotional:** empathy stimulated by turn-taking.

Stainless Steel Slide, High

KPL304



The stainless-steel slides with one-piece slide bed are made of high-quality stainless-steel AISI 304.



The steel surfaces are hot dip galvanised inside and outside with lead free zinc. The galvanisation has excellent corrosion resistance in outside environments and requires low maintenance.



Panels of 19mm EcoCore™. EcoCore™ is a highly durable, eco friendly material, which is not only recyclable after use, but also consists of material produced from +95% recycled post consumer material from food packing waste.

Item no. KPL304-0601	
Installation Information	
Max. fall height	185 cm
Safety surfacing area	23.1 m ²
Total installation time	3.9
Excavation volume	0.34 m ³
Concrete volume	0.07 m ³
Footing depth (standard)	60 cm
Shipment weight	175 kg
Anchoring options	In-ground ✓ Surface ✓
Warranty Information	
EcoCore HDPE	Lifetime
Hot dip galvanised steel	Lifetime
Spare parts guaranteed	10 years
Stainless steel slide	10 years



Sustainability Data

KPL304



Cradle to Gate A1-A3	Total CO ₂ emission	CO ₂ e/kg	Recycled materials
	kg CO ₂ e	kg CO ₂ e/kg	%
KPL304-0601	395.21	3.45	51.18

The overall framework applied for these factors is the Environmental Product Declaration (EPD), which quantifies "environmental information on the life cycle of a product and enable comparisons between products fulfilling the same function" (ISO, 2006). This follows the structure and applies a Life-Cycle Assessment approach to the entire Product stage from raw material through manufacturing (A1-A3))

Kompan A/S
 C.F. Tietgens Boulevard 32C
 DK-5220 Odense SØ
 Denmark



Verification of CO₂ calculation of: Freestanding play equipment



Data version no. 2023-10-05

The CO₂ calculation and data are in compliance with the principles of a carbon footprint impact according to the GHG protocol (Greenhouse Gas Protocol), Scope 3, cradle to gate related to all individual components in the product category: "Freestanding play equipment" represented by item no.: GXY916012-3417.

(Scope 3 emissions include emission sources in the upstream and downstream value chain).

Date: 30. October 2023 | Valid until: 30. October 2025

Verified by:

Julie Marie Vejsgaard Larsen, LCA & EPD Consultant

Verification based on report: Validation of CO₂ calculation of 9 categories of Kompan product line, version 1.0, prepared by: Bureau Veritas HSE, Denmark: Julie M. V. Larsen.

Publication date: 30. October 2023

By Bureau Veritas HSE
 www.bureauveritas.dk
 +45 7731 1000



Stainless Steel Slide, High

KPL304

* Max fall height | ** Total height | *** Safety surfacing area

* Max fall height | ** Total height

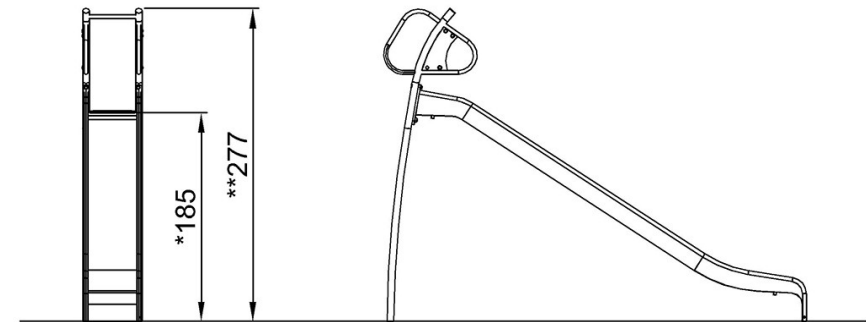
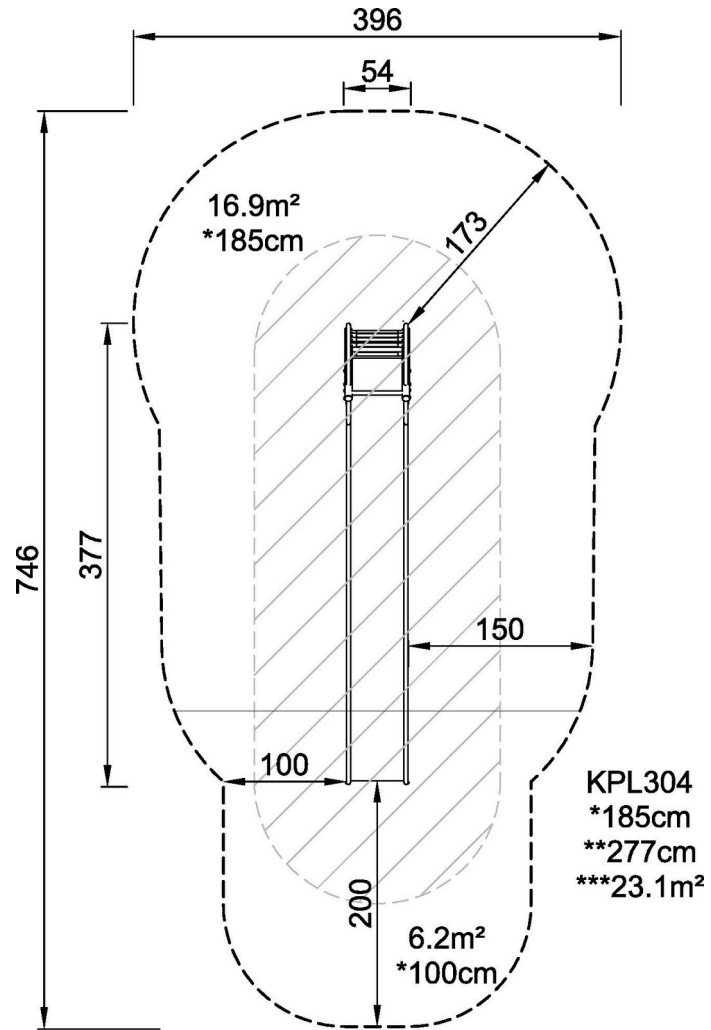

KPL304

[Click to see TOP VIEW](#)

[Click to see SIDE VIEW](#)