

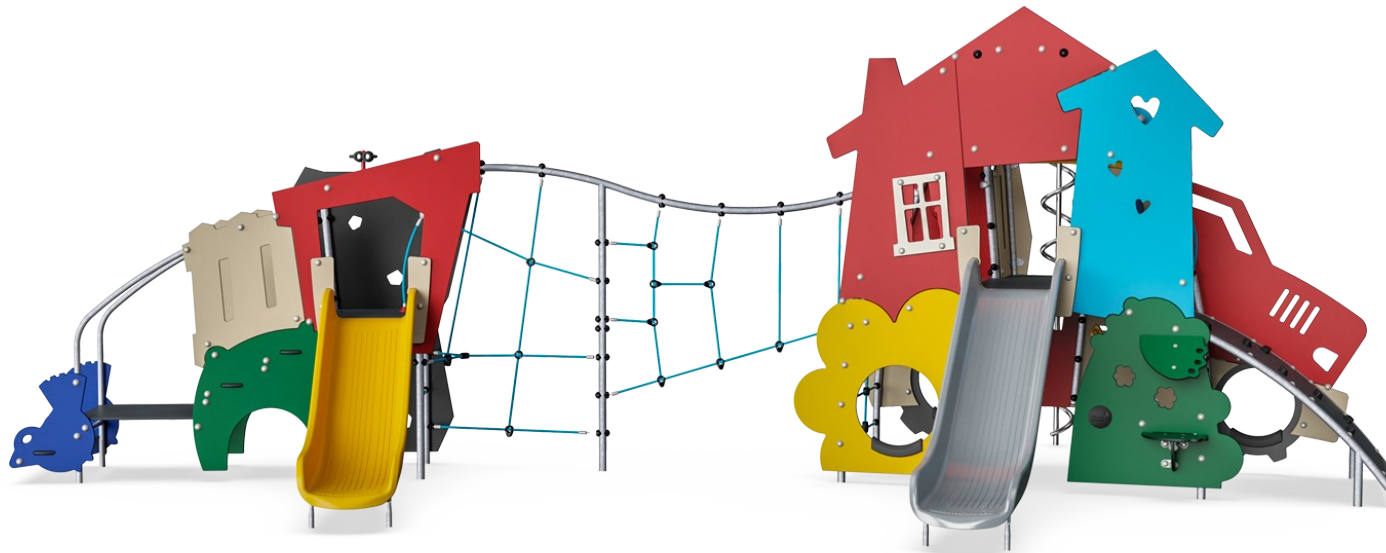

Home & Rescue with Net Tower

MSC6411



Item no. MSC641100-3717P	
General Product Information	
Dimensions LxWxH	823x472x285 cm
Age group	2+
Play capacity (users)	30
Colour options	

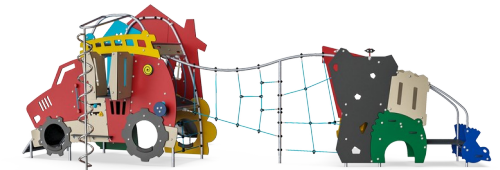
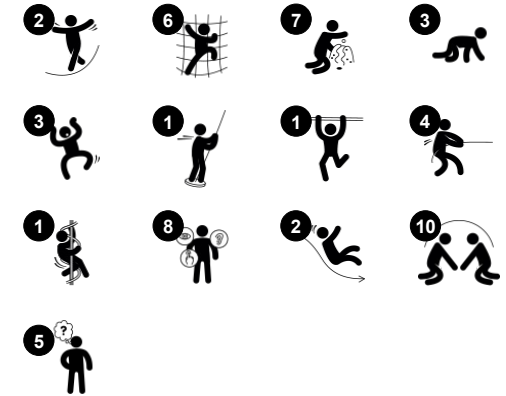

WOW! The roomy Home & Rescue themes hugely appeal to children's dramatic play stories. The ground level den invites a break time with friends. There is a Home side and a Rescue side, inspiring vigorous play stories. Thanks to the two-sided themed panels and the varied climbers: curved, round, straight and net climbers, there are challenges for a wide

user group. The climbing events, slides and glides train motor skills, such as cross-coordination and balance, important for navigating the world confidently. The meeting points are many, as the Home & Rescue can be played from all sides. The huge net adds volume and active meeting. From the upper level, children can look communicate through

the window with ground level. So the social play invitation is immense. Children meet, greet and play, making friends for life.



Home & Rescue with Net Tower

MSC6411



Binoculars

Cognitive: the binoculars promote dramatic play, a great trainer of language and communication skills. **Creative:** the binoculars can be moved around. Looking through them gives a new perspective on the world.



Accessible stairway

Physical: climbing the accessible stairway is for all and supports cross coordination as well as arm and leg muscles. **Social-Emotional:** room for active breaks and adult helpers. An inclusive space.



Climbing net

Physical: children develop cross-body coordination and muscle strength. The asymmetry of the net challenges the children's climbing.



Curly climber

Physical: supports coordination going down, sense of balance when rotating and arm muscles for holding tight. **Social-Emotional:** empathy stimulated by turn-taking. **Cognitive:** logical thinking when placing arms and legs right for rotating downwards.



Den

Physical: crawling through the possible openings trains spatial awareness. **Social-Emotional:** the enclosed space invites social play for two or three children.



Crawl-through hole

Physical: the hole allows for climbing and crawling through, developing cross coordination, proprioception and spatial awareness. **Social-Emotional:** cooperation and turn-taking when passing one another. **Cognitive:** understanding space, shape and measures when seeing if the body can fit through the hole.



Slide

Physical: develops spatial awareness, sense of balance and trains core muscles when sitting upright going down. **Social-Emotional:** empathy stimulated by turn-taking. **Cognitive:** young children develop their understanding of space, speed and distances when sliding down.

Home & Rescue with Net Tower

MSC6411

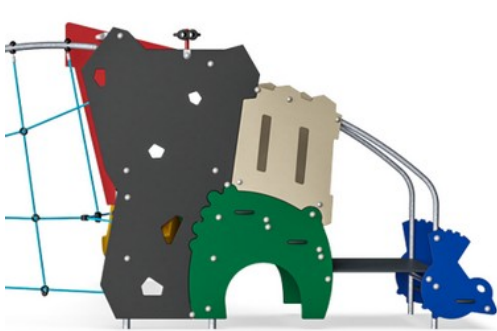

Panels of 19mm EcoCore™. EcoCore™ is a highly durable, eco-friendly material, which is not only recyclable after use but also consists of a core produced from 100% recycled material.

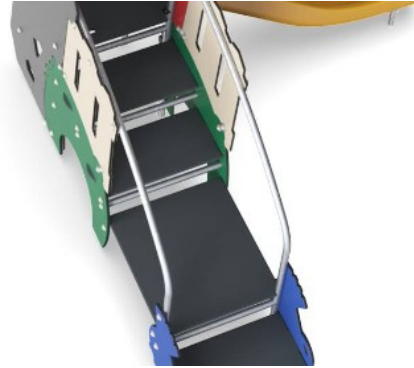

All floors are made from high-pressure laminate HPL with a thickness 17.8mm and non-skid surface texture. KOMPAN HPL is high wearing and suitable for all climates.

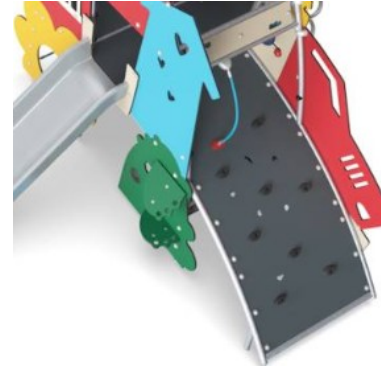

The curved climbing wall is made of Ekogrip® panel that consists of a 15mm thick PE base with 3 mm top-layer of soft rubber with a non-skid effect.



The slide is made of moulded PE, which has high impact resistance across a wide temperature span and is vandal resistance.

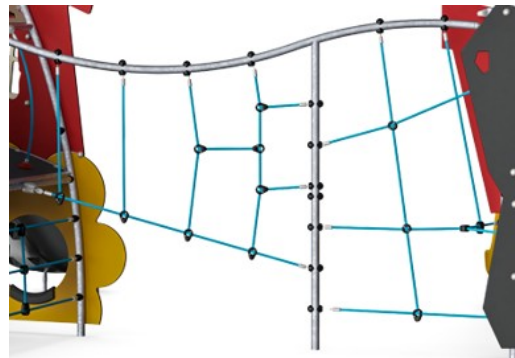

Ropes are made of UV-stabilized PP rope strands with inner steel cable reinforcement. Horizontal ropes are PUR coated to obtain good wear and tear resistance.

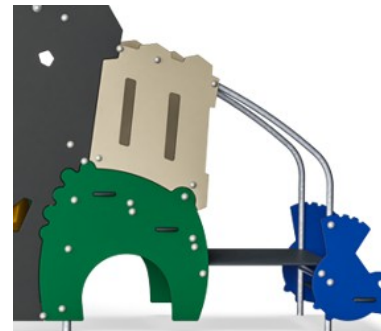

The steel surfaces are hot-dip galvanised inside and outside with lead-free zinc. The galvanisation has excellent corrosion resistance in outside environments and requires low maintenance.

Item no. MSC641100-3717P

Installation Information

Max. fall height	226 cm
Safety surfacing area	58.0 m ²
Total installation time	32.7
Excavation volume	1.54 m ³
Concrete volume	0.00 m ³
Footing depth (standard)	90 cm
Shipment weight	1,028 kg
Anchoring options	In-ground ✓ Surface ✓

Warranty Information

EcoCore HDPE	Lifetime
Galvanised Steel	Lifetime
HPL Decks	15 years
Ropes & Nets	10 years
Spare Parts Guarantee	10 years



Sustainability Data

MSC6411

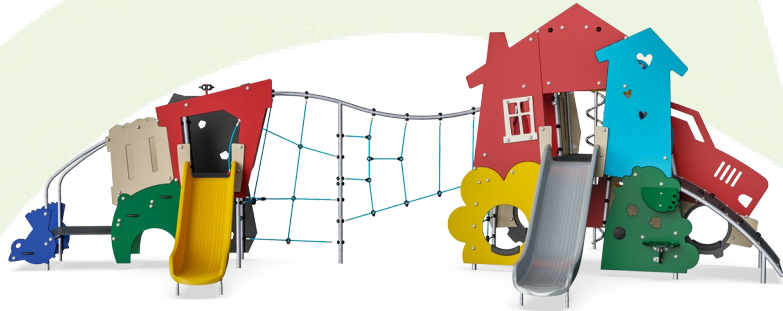

Cradle to Gate A1-A3	Total CO ₂ emission	CO ₂ e/kg	Recycled materials
	kg CO ₂ e	kg CO ₂ e/kg	%
MSC641100-3717P	1,922.24	2.26	53.78

The overall framework applied for these factors is the Environmental Product Declaration (EPD), which quantifies "environmental information on the life cycle of a product and enable comparisons between products fulfilling the same function" (ISO, 2006). This follows the structure and applies a Life-Cycle Assessment approach to the entire Product stage from raw material through manufacturing (A1-A3))

Kompan A/S
 C.F. Tietgens Boulevard 32C
 DK-5220 Odense SØ
 Denmark



Verification of CO₂ calculation of: Themed play systems



Data version no. 2023-10-05

The CO₂ calculation and data are in compliance with the principles of a carbon footprint impact according to the GHG protocol (Greenhouse Gas Protocol), Scope 3, cradle to gate related to all individual components in the product category: "Themed play systems" represented by item no.: MSC641100-3717P.

(Scope 3 emissions include emission sources in the upstream and downstream value chain).

Date: 30. October 2023 | Valid until: 30. October 2025

Verified by:

Julie Marie Vejsgaard Larsen, LCA & EPD Consultant

Verification based on report: Validation of CO₂ calculation of 9 categories of Kompan product line, version 1.0, prepared by: Bureau Veritas HSE, Denmark: Julie M. V. Larsen.

Publication date: 30. October 2023

By Bureau Veritas HSE
 www.bureauveritas.dk
 +45 7731 1000



Home & Rescue with Net Tower

MSC6411

* Max fall height | ** Total height | *** Safety surfacing area

* Max fall height | ** Total height

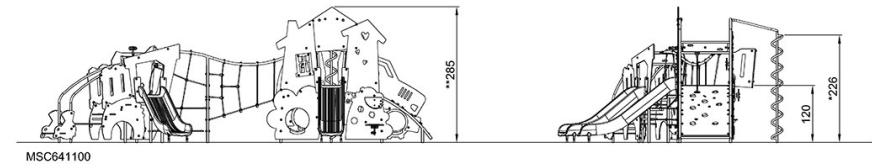
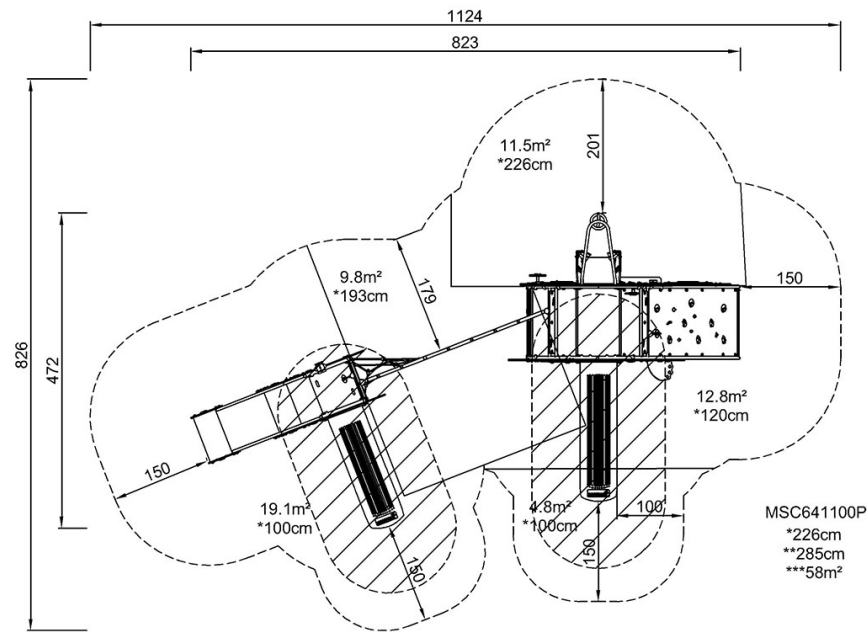

[Click to see TOP VIEW](#)

[Click to see SIDE VIEW](#)