

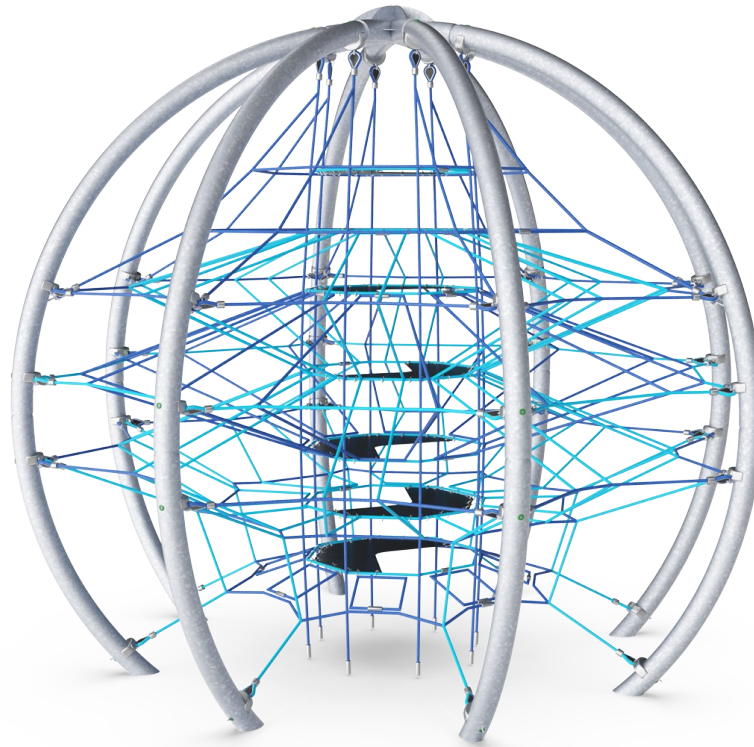

# Crystal Sphere

COR88200



Item no. COR882001-0412	
<b>General Product Information</b>	
Dimensions LxWxH	499x499x435 cm
Age group	5+
Play capacity (users)	51
Colour options	

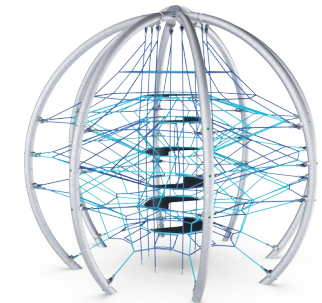
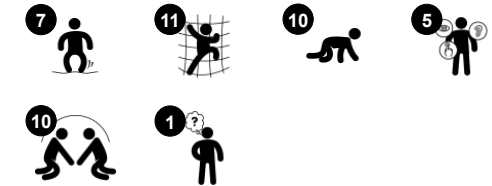

The eight legged, spider-like Crystal Sphere hugely excites children. Its webs and climbing opportunities will attract children to come back to play again and again. The interconnected nets and rubber ladders offer fun and challenging climbs: when one child moves it affects all the other climbers in the huge, bouncing web of nets. The Crystal Sphere

caters for a lot of children to play at the same time. Apart from being great fun, the Miracle Sphere trains of all major muscle groups and fundamental motor skills: all muscles are in use when clinging onto the ropes or climbing up high. Important motor skills such as cross-body coordination and spatial awareness are trained. These skills are fundamental for example when

judging distances and managing traffic securely. The swaying web calls for consideration and turn-taking, social-emotional skills learned in play in the Crystal Sphere.

# Crystal Sphere

COR88200

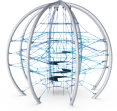

## Transparency

**Social-Emotional:** the transparency makes possible cooperation and communication throughout, all important life-skills for children to learn.

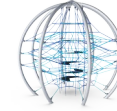
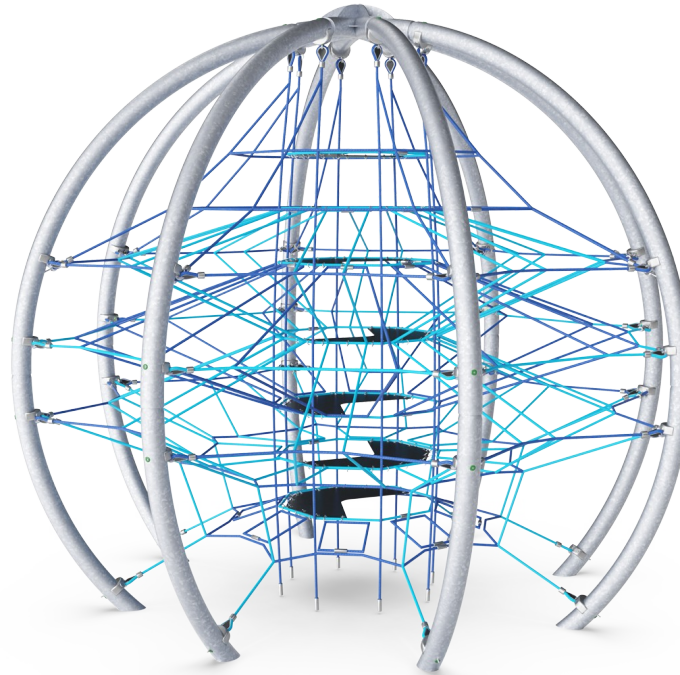

## Big meshes

**Physical:** the big meshes allow for climbing and crawling, supporting proprioception, cross coordination and spatial awareness. Climbing here takes muscle strength, pushing and pulling arms to get upwards. **Social-Emotional:** allow more children being seated together, sharing.

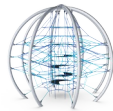

## Connected nets

**Physical:** the connected nets make the climbers feel the movements of the others, adding a dimension of fun and demanding concentration when holding tight to the rope. Cross-coordination and all muscle groups are trained. **Social-Emotional:** the climbers' movements affect the other climbers, so consideration and turn-taking is supported.



## Membrane loops

**Physical:** develops leg, arm and core muscles as well as motor skills such as cross coordination and proprioception. **Social-Emotional:** showing consideration of others and helping others when passing one another going up or down.

# Crystal Sphere

COR88200



Corocord membranes consist of friction-proof rubberized material of conveyor belt quality with excellent UV resistance. Tested and compliant with REACH requirements for PAH. Embedded is a four-layered armouring made of woven polyester. The armouring and the two surface layers result in a total thickness of 7.5 mm.



Corocord aluminium clamps are used as connectors between steel posts and rope. The aluminium casting is screwed into the steel post and connects safely to the rope.



Fully coloured EPDM rubber discs with smooth surface. The moulded EPDM surrounds a hot dip galvanised steel core that ensures both the stability of the discs and durable fixation to the rope.



Ropes of UV-stabilized PES rope strands with inner steel cable reinforcement. The polyester yarn is made from +95% post-consumer materials and is inductively melted onto each strand. The ropes are highly wear- and vandalism-resistant and can be replaced at site if needed.



Corocord 'S' clamps are used as universal connections in Corocord products. 8mm stainless steel rods with rounded edges are pressed around the ropes with a special hydraulic press, making them the ideal connector: safe, durable and vandalism-proof, all while allowing the typical movement of rope play structures.

Item no. COR882001-0412

## Installation Information

Max. fall height	255 cm
Safety surfacing area	72.5 m <sup>2</sup>
Total installation time	32.0
Excavation volume	7.07 m <sup>3</sup>
Concrete volume	2.72 m <sup>3</sup>
Footing depth (standard)	65 cm
Shipment weight	1,303 kg
Anchoring options	In-ground ✓

## Warranty Information

Aluminium clamps	10 years
Corocord rope	10 years
Membrane	2 years
S-Clamps	10 years
Spare parts guaranteed	10 years



# Sustainability Data

COR88200

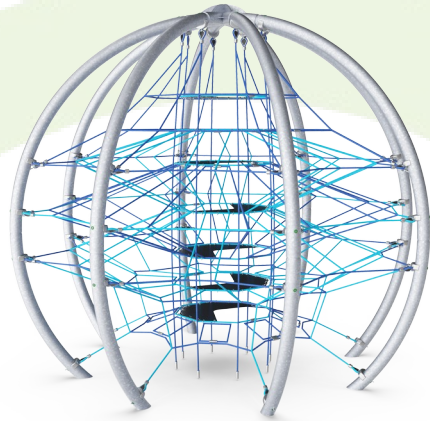

Cradle to Gate A1-A3	Total CO <sub>2</sub> emission	CO <sub>2</sub> e/kg	Recycled materials
	kg CO <sub>2</sub> e	kg CO <sub>2</sub> e/kg	%
<b>COR882001-0412</b>	3,541.36	3.34	45.18

The overall framework applied for these factors is the Environmental Product Declaration (EPD), which quantifies "environmental information on the life cycle of a product and enable comparisons between products fulfilling the same function" (ISO, 2006). This follows the structure and applies a Life-Cycle Assessment approach to the entire Product stage from raw material through manufacturing (A1-A3))

**Kompan A/S**  
 C.F. Tietgens Boulevard 32C  
 DK-5220 Odense SØ  
 Denmark



## Verification of CO<sub>2</sub> calculation of: Corocord



Data version no. 2023-10-05

The CO<sub>2</sub> calculation and data are in compliance with the principles of a carbon footprint impact according to the GHG protocol (Greenhouse Gas Protocol), Scope 3, cradle to gate related to all individual components in the product category: "Corocord" represented by item no.: COR314011-1101.

(Scope 3 emissions include emission sources in the upstream and downstream value chain).

**Date: 30. October 2023 | Valid until: 30. October 2025**

Verified by:

Julie Marie Vejsgaard Larsen, LCA & EPD Consultant

Verification based on report: Validation of CO<sub>2</sub> calculation of 9 categories of Kompan product line, version 1.0, prepared by: Bureau Veritas HSE, Denmark: Julie M. V. Larsen.

**Publication date: 30. October 2023**

By Bureau Veritas HSE  
 www.bureauveritas.dk  
 +45 7731 1000



# Crystal Sphere

COR88200

\* Max fall height | \*\* Total height | \*\*\* Safety surfacing area

\* Max fall height | \*\* Total height

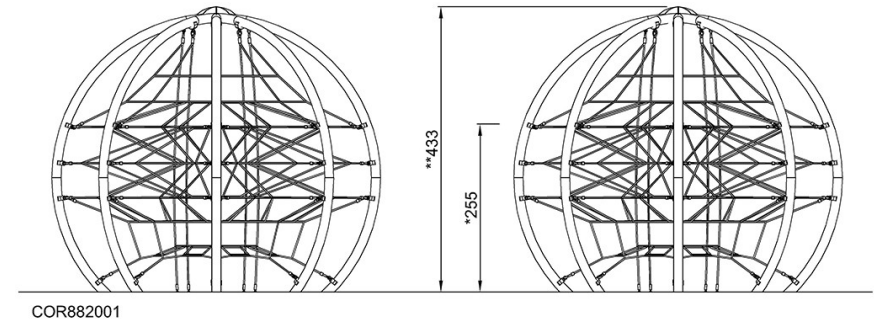
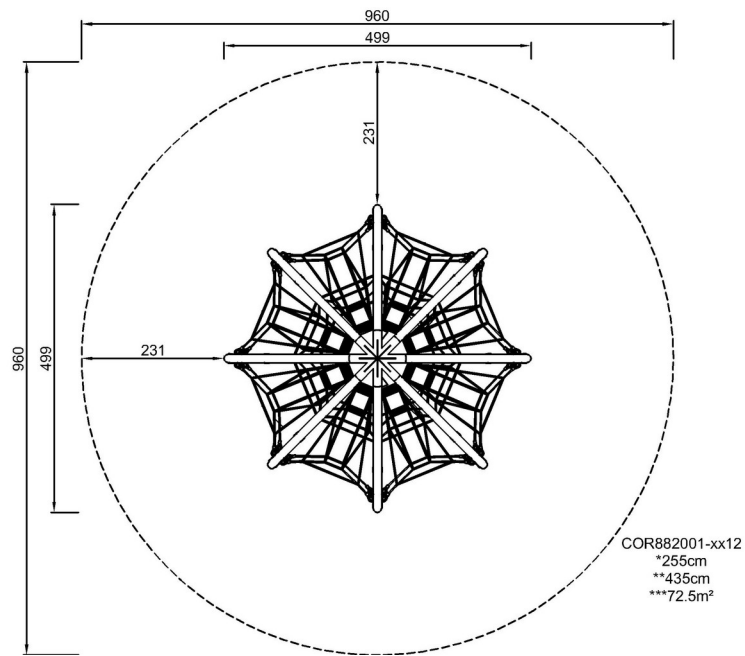

[Click to see TOP VIEW](#)

[Click to see SIDE VIEW](#)