

Seven Tower XL

KPL7001



Item no. KPL700111-0901

General Product Information

Dimensions LxWxH	674x608x274 cm
Age group	2+
Play capacity (users)	43
Colour options	● ●

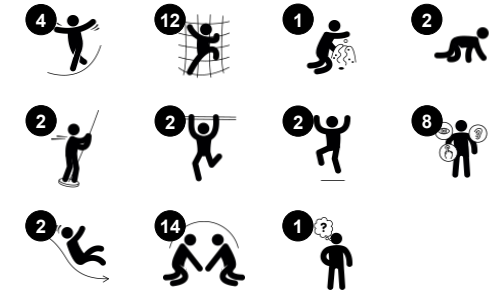

This seven tower play structure offers rich play variation and a high play capacity. This combination will make children play for a long time and want to come back again and again. On ground level, three different play panels create each their fun play retreat. The many different ways of climbing up on the platforms, via different ladders and climbing walls make

play explorations worthwhile. They additionally train the child's cross-coordination and muscles. The links between towers have different characteristics, from the classic, permeated tunnel to stable as well as wobbly net crossings. The way down can be graduated from the fast slide to the dare-devil fireman's pole. Playing here guarantees training of all

major physical development areas. It also guarantees fun play with friends, stimulating social-emotional developmental domains. But not least, promoting friendships in fun, playful ways.

Seven Tower XL

KPL7001



Crawl-through hole

Physical: the hole allows for climbing and crawling through, developing cross coordination, proprioception and spatial awareness. **Social-Emotional:** cooperation and turn-taking when passing one another. **Cognitive:** understanding space, shape and measures when seeing if the body can fit through the hole.



Ring game

Social-Emotional: cooperating from both sides on running rings up and down trains turn-taking and cooperation skills. **Cognitive:** figuring out how to turn the ring to make it fit the holes and move up or down trains logical skills. **Creative:** leaving rings in new positions leaves a mark in the playground.



Tunnel

Physical: the children crawl through the tunnel, developing motor skills such as cross-body coordination and proprioception. **Social-Emotional:** turn-taking when passing each other.



Net bridge

Physical: children develop their balance, cross coordination and spatial awareness in the open net. **Social-Emotional:** interaction with children outside, socializing. Cooperation and consideration, e.g. when passing others.



Slide

Physical: sliding develops spatial awareness and a sense of balance. Furthermore, the core muscles are trained when sitting upright going down. **Social-Emotional:** empathy stimulated by turn-taking. **Cognitive:** young children develop their understanding of space, speed and distances when sliding down quickly.



Shop

Social-Emotional: sharing and cooperation from both sides create a social scenario that supports communication and cooperation. **Cognitive:** the counter invites dramatic play scenarios such as playing shop. This stimulates language and communication.



Rock climber

Physical: supports cross coordination and leg, arm and hand strength. **Social-Emotional:** the inclination makes climbing feel secure, especially for younger children.

Seven Tower XL

KPL7001



Panels of 19mm EcoCore™. EcoCore™ is a highly durable, eco friendly material, which is not only recyclable after use, but also consists of material produced from +95% recycled post consumer material from food packing waste.

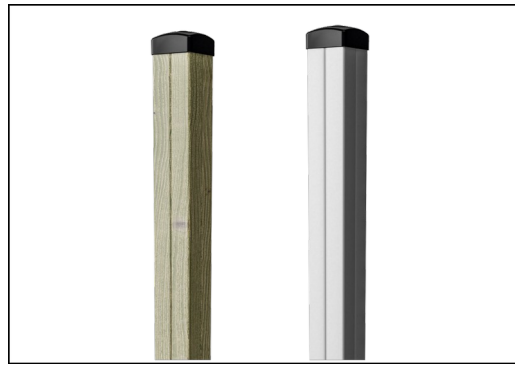

The main tower posts are available in two types of material: European pine wood posts, pressure impregnated Class 3 with Tanalith E3475 according to EN335 (Equivalent to NTR Class AB). Aluminum post t=2mm with anodized surface treatment. Base material EN AW-6060 T66.

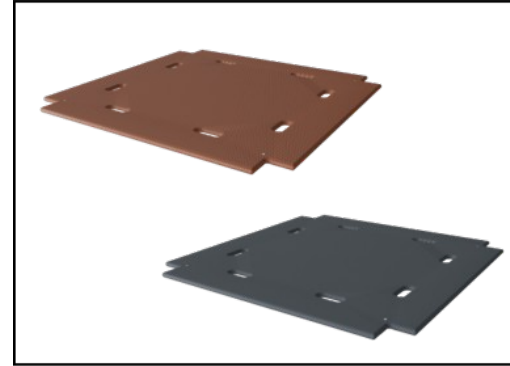

Floors and panel activities are available in two types of material: Waterproof plywood decks thickness 21.5mm from pine and alder wood with anti-slip film on both sides. High Pressure Laminate HPL thickness 17.8mm with slip resistant surface texture according to EN 438-6.

Item no. KPL700111-0901

Installation Information

Max. fall height	118 cm
Safety surfacing area	65.2 m ²
Total installation time	39.9
Excavation volume	4.17 m ³
Concrete volume	0.00 m ³
Footing depth (standard)	90 cm
Shipment weight	1,109 kg
Anchoring options	In-ground ✓ Surface ✓

Warranty Information

Aluminum	15 years
Corocord rope	10 years
EcoCore HDPE	Lifetime
Pinewood	10 years
Spare parts guaranteed	10 years

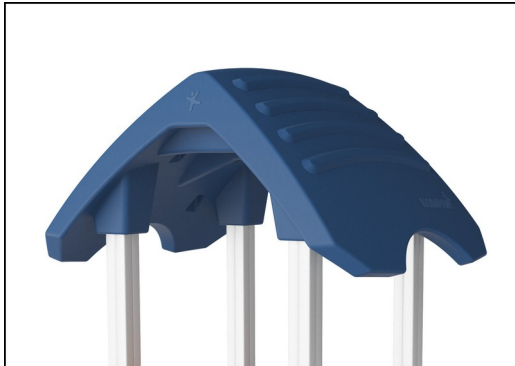

The large hollow components are made of 100% recyclable PE. The roof displayed is moulded in one piece with minimum 5,5mm wall thickness to ensure high durability in all climates around the world.

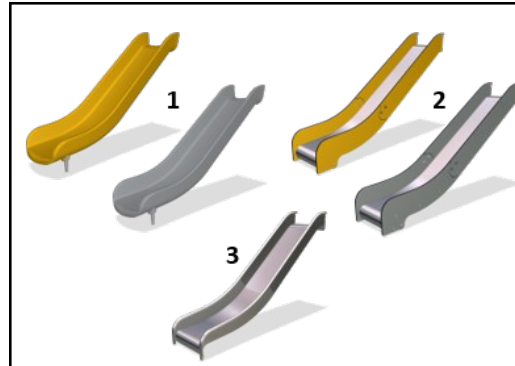

Slides are available in three different materials: moulded on piece PE slides made from 33% post-consumer materials, Combined EcoCore™ sides and stainless steel slide bed t=2mm. Full stainless steel AISI304 t=2mm.



Climbing nets are made of UV-stabilised PP rope with inner steel cable reinforcement. The rope is induction treated to obtain maximum fixation between steel and rope which provides excellent wear and tear resistance. All rope connectors are made of 100% recyclable PA material.



Sustainability Data

KPL7001



Cradle to Gate A1-A3	Total CO ₂ emission	CO ₂ e/kg	Recycled materials
	kg CO ₂ e	kg CO ₂ e/kg	%
KPL700111-0901	1,316.09	1.55	32.31

The overall framework applied for these factors is the Environmental Product Declaration (EPD), which quantifies "environmental information on the life cycle of a product and enable comparisons between products fulfilling the same function" (ISO, 2006). This follows the structure and applies a Life-Cycle Assessment approach to the entire Product stage from raw material through manufacturing (A1-A3))

Kompan A/S
 C.F. Tietgens Boulevard 32C
 DK-5220 Odense SØ
 Denmark



Verification of CO₂ calculation of: Play systems



Data version no. 2023-10-05

The CO₂ calculation and data are in compliance with the principles of a carbon footprint impact according to the GHG protocol (Greenhouse Gas Protocol), Scope 3, cradle to gate related to all individual components in the product category: "Play systems" represented by item no.: PCM200321-0950.

(Scope 3 emissions include emission sources in the upstream and downstream value chain).

Date: 30. October 2023 | Valid until: 30. October 2025

Verified by:

Julie Marie Vejsgaard Larsen, LCA & EPD Consultant

Verification based on report: Validation of CO₂ calculation of 9 categories of Kompan product line, version 1.0, prepared by: Bureau Veritas HSE, Denmark: Julie M. V. Larsen.

Publication date: 30. October 2023

By Bureau Veritas HSE
 www.bureauveritas.dk
 +45 7731 1000



Seven Tower XL

KPL7001

* Max fall height | ** Total height | *** Safety surfacing area

* Max fall height | ** Total height

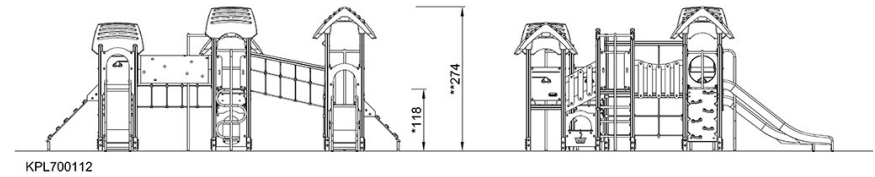
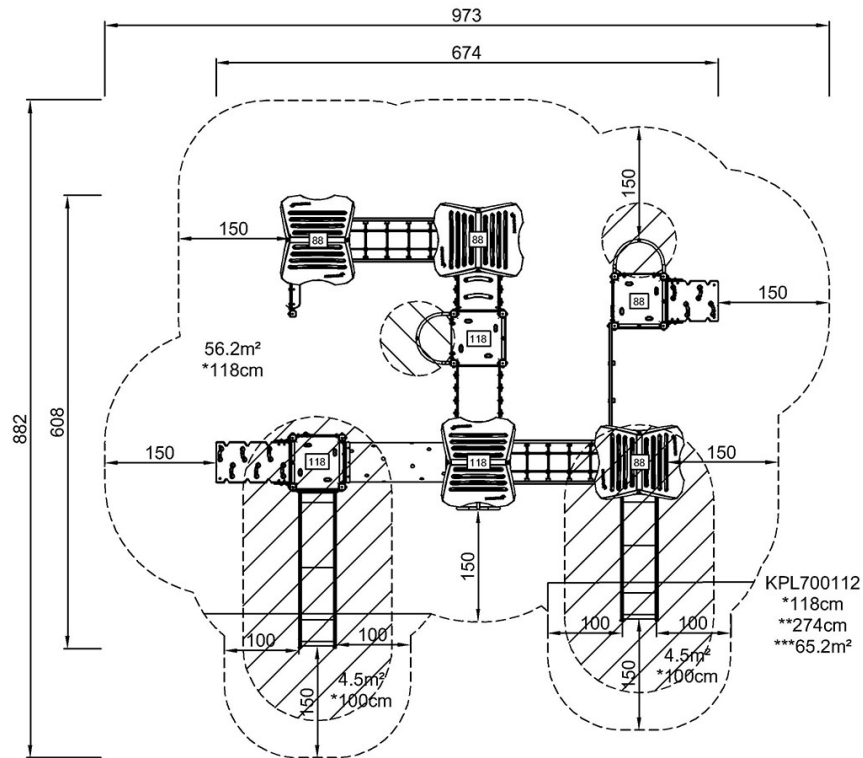

KPL700112

[Click to see TOP VIEW](#)

[Click to see SIDE VIEW](#)