

Dragite

COR47330

Item no. COR473301-0406

General Product Information

Dimensions LxWxH	437x437x436 cm
Age group	5 - 12
Play capacity (users)	28
Colour options	

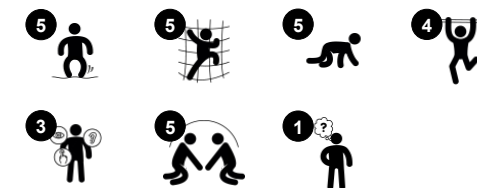
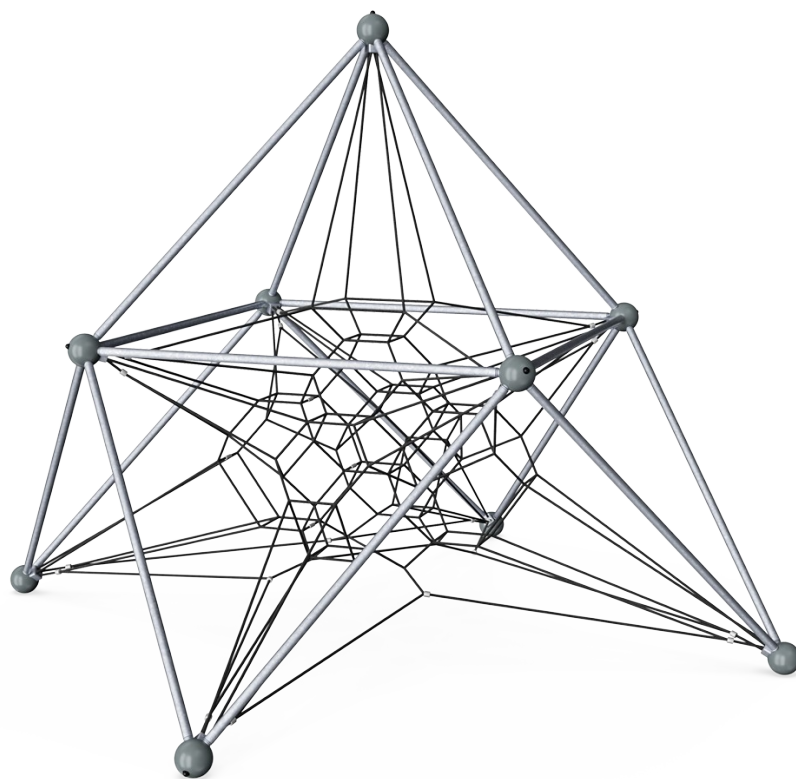

The responsive, bouncy ropes and nets of the Dragite attracts children hugely. The varied climbing and meeting options make them want to come back again and again. The transparency of the nets make communication possible across the net. The symmetry of the net cubes supports climbing for younger or less confident climbers, and variation for all. The

side ropes function as meeting and retraction spots in the climbing landscape and make possible hanging in arms, training upper body muscles. This is important to children today, as they lead increasingly sedentary lifestyles. Concentration is needed when climbing, as the ropes are interconnected and reflect the movements of all climbers, throughout the net.

This trains the muscles, cross-body coordination and spatial awareness, important for security in motion.

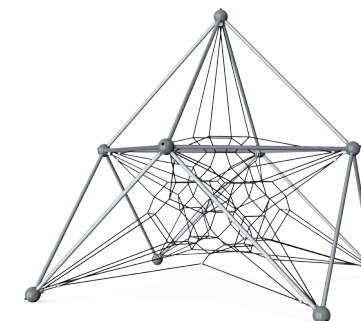

Dragite

COR47330

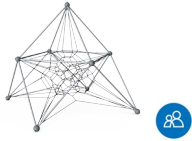

Height

Social-Emotional: children develop courage and self-regulation when being up high. This positively affects self-confidence.

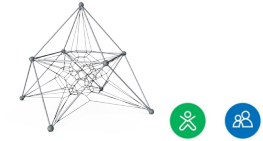
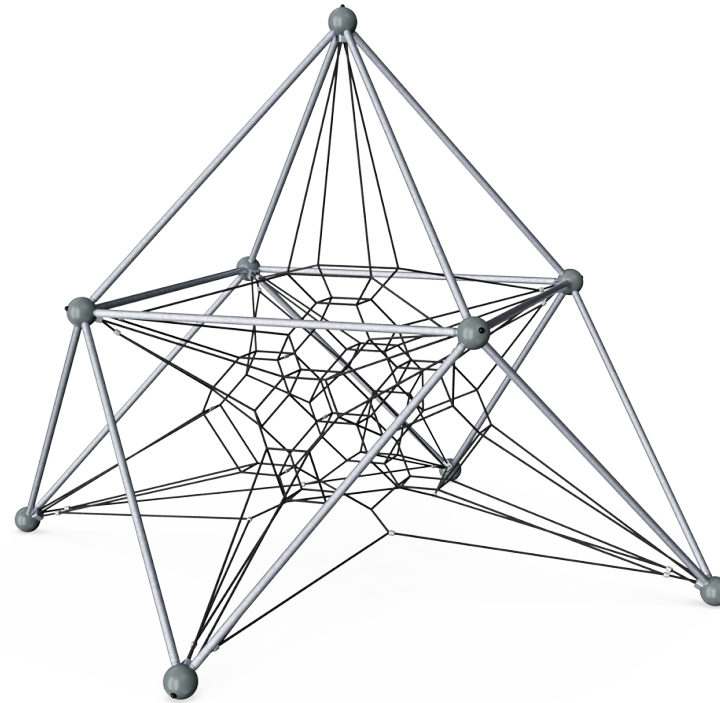

Connected nets

Physical: the connected nets make the climbers feel the movements of the others, adding a dimension of fun and demanding concentration when holding tight to the rope. Cross-coordination and all muscle groups are trained. **Social-Emotional:** the climbers' movements affect the other climbers, so consideration and turn-taking is supported.

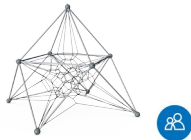

Transparency

Social-Emotional: the transparency makes possible cooperation and communication throughout, all important life-skills for children to learn.



Big meshes

Physical: the big meshes allow for climbing and crawling, supporting proprioception, cross coordination and spatial awareness. Climbing here takes muscle strength, pushing and pulling arms to get upwards. **Social-Emotional:** allow more children being seated together, sharing.

Dragite

COR47330



Corocord 'S' clamps are used as universal connections in Corocord products. 8mm stainless steel rods with rounded edges are pressed around the ropes with a special hydraulic press, making them the ideal connector: safe, durable and vandalism-proof, all while allowing the typical movement of rope climbing structures.



The aluminium swages of the net are double conical with rounded ends and are as small as safety allows. The overall net design aims at keeping metal parts within the net to an absolute minimum, both in size and number, in order to provide the best possible rope climbing experience.



Corocord membranes consist of friction-proof rubberized material of conveyor belt quality with excellent UV resistance. Tested and compliant with REACH requirements for PAH. Embedded is a four-layered armouring made of woven polyester. The armouring and the two surface layers result in a total thickness of 7.5 mm.

Item no. COR473301-0406	
Installation Information	
Max. fall height	230 cm
Safety surfacing area	60.4 m ²
Total installation time	15.1
Excavation volume	1.76 m ³
Concrete volume	0.98 m ³
Footing depth (standard)	120 cm
Shipment weight	483 kg
Anchoring options	In-ground ✓
Warranty Information	
Corocord rope	10 years
EcoCore HDPE	Lifetime
Hot dip galvanised steel	Lifetime
S-Clamps	10 years
Spare parts guaranteed	10 years



The steel struts are hot dip galvanised inside and outside with lead free zinc. The galvanisation has excellent corrosion resistance in outside environments and requires low maintenance.

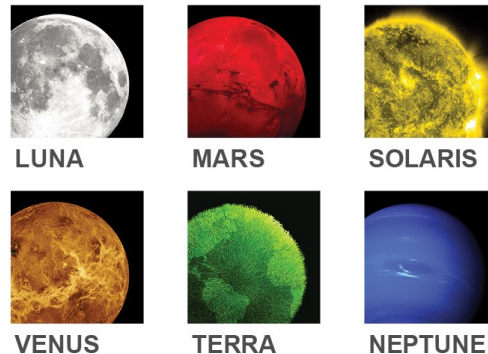

The COROCORD Frame Nets are available in 6 galactic colour themes. The themes draw on bright colours that appeal to children of all ages. Can be changed in the configurator.

Elevated activities 0	Accessible elevated activities	Accessible ground level activities	Accessible ground level play types
Present	0	1	1
Required	0	1	1



Sustainability Data

COR47330

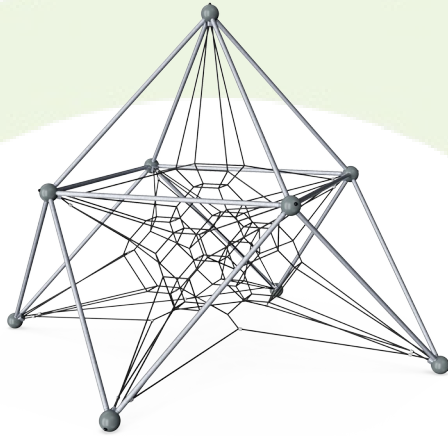

Cradle to Gate A1-A3	Total CO ₂ emission	CO ₂ e/kg	Recycled materials
	kg CO ₂ e	kg CO ₂ e/kg	%
COR473301-0406	1,373.93	3.64	45.99

The overall framework applied for these factors is the Environmental Product Declaration (EPD), which quantifies "environmental information on the life cycle of a product and enable comparisons between products fulfilling the same function" (ISO, 2006). This follows the structure and applies a Life-Cycle Assessment approach to the entire Product stage from raw material through manufacturing (A1-A3))

Kompan A/S
 C.F. Tietgens Boulevard 32C
 DK-5220 Odense SØ
 Denmark



Verification of CO₂ calculation of: Corocord



Data version no. 2023-10-05

The CO₂ calculation and data are in compliance with the principles of a carbon footprint impact according to the GHG protocol (Greenhouse Gas Protocol), Scope 3, cradle to gate related to all individual components in the product category: "Corocord" represented by item no.: COR314011-1101.

(Scope 3 emissions include emission sources in the upstream and downstream value chain).

Date: 30. October 2023 | Valid until: 30. October 2025

Verified by:

Julie Marie Vejsgaard Larsen, LCA & EPD Consultant

Verification based on report: Validation of CO₂ calculation of 9 categories of Kompan product line, version 1.0, prepared by: Bureau Veritas HSE, Denmark: Julie M. V. Larsen.

Publication date: 30. October 2023

By Bureau Veritas HSE
 www.bureauveritas.dk
 +45 7731 1000



Dragite

COR47330

* Max fall height | ** Total height | *** Safety surfacing area

* Max fall height | ** Total height

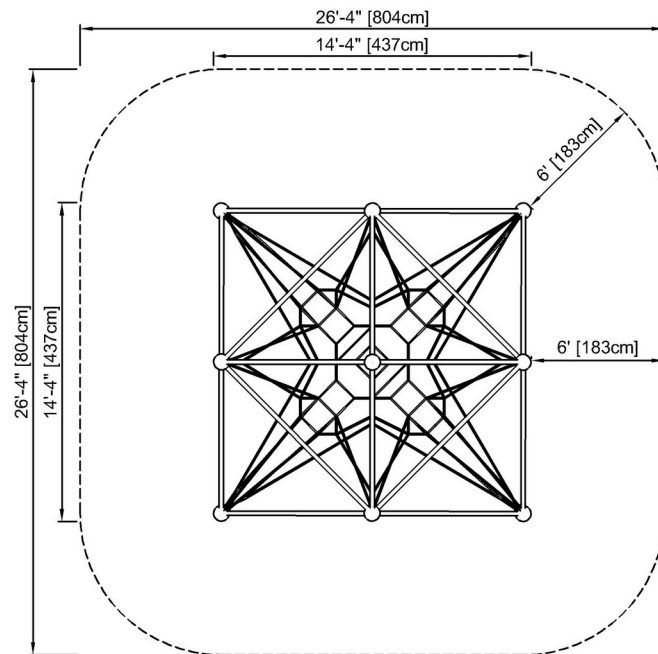

COR473301-xx01
* 7'-7" / 230cm
** 13'-12" / 426cm
*** 661ft² / 61.4m²

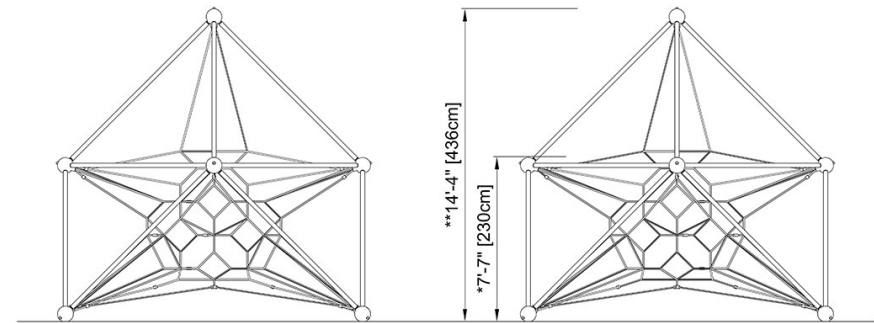

COR473301

[Click to see TOP VIEW](#)

[Click to see SIDE VIEW](#)