

# Little Mermaid & Tinderbox with Castle

MSC6432

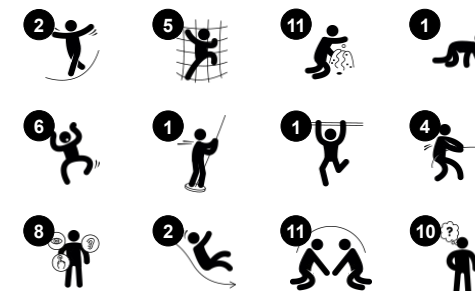

Item no. MSC643200-3717P	
General Product Information	
Dimensions LxWxH	743x449x369 cm
Age group	2+
Play capacity (users)	27
Colour options	●



The highly appealing fairytale themes of The Little Mermaid and the Tinderbox have a huge attraction on all children and adults. The QR-codes give free access to a whole fairytale world with e-books and educational games, available in 16 languages. The awesome variety of play events for the mind and body attract children to play and explore, time and

again. The fairytale manipulatives inspire dramatic play, which is a great way of improving language skills. These play features also train logical thinking skills when children figure out their function. All these elements can be worked from both sides of the panels, spurring social interaction and adding play capacity. The wide variety of climbing, sliding,

and jumping activities train basic motor skills which are important for navigating the world securely. An awesome play universe that develops children through play.

# Little Mermaid & Tinderbox with Castle

MSC6432



## Curved climbing wall

**Physical:** children develop their cross-body coordination, proprioception and leg, arm and hand strength. Climbing on a curved surface is an extra challenge to muscles.



## Megaphone

**Social-Emotional:** inspires communication and turn-taking skills. **Cognitive:** distortion of sound evokes curiosity and stimulates an understanding of cause and effect.



## Fireman's pole

**Physical:** coordination is supported when going down, as well as arm and core muscles. Landing strengthens bone density, which is built for life in early childhood. **Social-Emotional:** turn-taking and risk-taking. **Cognitive:** young children develop their understanding of space, speed and distances when gliding down fast.

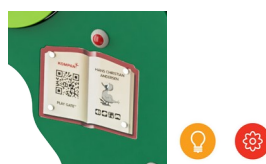

## Book with QR-code

**Cognitive:** scan the code and access a range of e-books and educational games in your native or 15 other languages. Scanning in a range of e-books with fairytales or playful learning games, centered around languages and story-telling. **Creative:** scanning in an AR (Augmented Reality) element that allows for creating photos in real time with figures from the Hans Christian Andersen fairytales.



## Slide

**Physical:** sliding develops spatial awareness and a sense of balance. Furthermore, the core muscles are trained when sitting upright going down. **Social-Emotional:** empathy stimulated by turn-taking. **Cognitive:** young children develop their understanding of space, speed and distances when sliding down quickly.



## Rock climber

**Physical:** supports cross coordination and leg, arm and hand strength. **Social-Emotional:** the inclination makes climbing feel secure, especially for younger children.



## Binoculars

**Cognitive:** the binoculars set a tangible theme and thus spur dramatic play. Dramatic play is a great trainer of language and communication skills. **Creative:** the binoculars can be turned in all directions. Looking through them gives a new perspective on the world.

# Little Mermaid & Tinderbox with Castle

MSC6432



Panels of 19mm EcoCore™. EcoCore™ is a highly durable, eco friendly material, which is not only recyclable after use, but also consists of material produced from +95% recycled post consumer material from food packing waste.

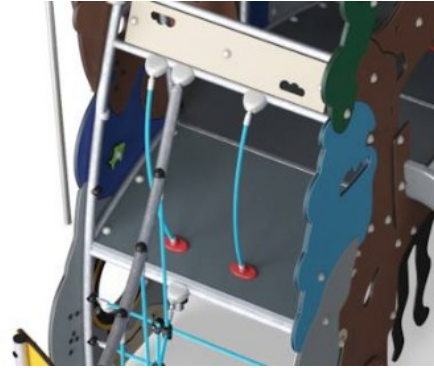

All floors are made of High-Pressure Laminate HPL with a thickness 17.8mm and non skid surface texture according to EN 438-6. KOMPAN HPL has high wearing strength to ensure long lifetime in all climates.

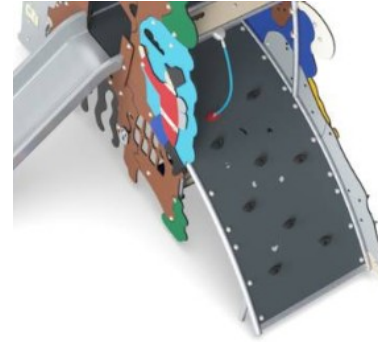

Curved climbing wall is made of Ekogrip® panel that consist of a 15mm thick PE base with 3 mm top-layer of soft rubber with a non-skid effect.

Item no. MSC643200-3717P

## Installation Information

Max. fall height	193 cm
Safety surfacing area	51.3 m <sup>2</sup>
Total installation time	39.9
Excavation volume	1.54 m <sup>3</sup>
Concrete volume	0.00 m <sup>3</sup>
Footing depth (standard)	90 cm
Shipment weight	1,107 kg
Anchoring options	In-ground ✓ Surface ✓

## Warranty Information

EcoCore HDPE	Lifetime
Hot dip galvanised steel	Lifetime
HPL decks	15 years
Ropes & nets	10 years
Spare parts guaranteed	10 years



The slides can be chosen in different materials: Straight moulded PE slides or combined EcoCore™ sides and stainless steel slide bed t=2mm.



Climbing nets are made of UV-stabilised PP rope with inner steel cable reinforcement. The rope is induction treated to obtain maximum fixation between steel and rope which provides excellent wear and tear resistance. All rope connectors are made of 100% recyclable PA material.



The steel surfaces are hot dip galvanised inside and outside with lead free zinc. The galvanisation has excellent corrosion resistance in outside environments and requires low maintenance.



# Sustainability Data

MSC6432



Cradle to Gate A1-A3	Total CO <sub>2</sub> emission	CO <sub>2</sub> e/kg	Recycled materials
	kg CO <sub>2</sub> e	kg CO <sub>2</sub> e/kg	%
<b>MSC643200-3717P</b>	1,915.68	2.16	57.44

The overall framework applied for these factors is the Environmental Product Declaration (EPD), which quantifies "environmental information on the life cycle of a product and enable comparisons between products fulfilling the same function" (ISO, 2006). This follows the structure and applies a Life-Cycle Assessment approach to the entire Product stage from raw material through manufacturing (A1-A3))

**Kompan A/S**  
 C.F. Tietgens Boulevard 32C  
 DK-5220 Odense SØ  
 Denmark



## Verification of CO<sub>2</sub> calculation of: Themed play systems

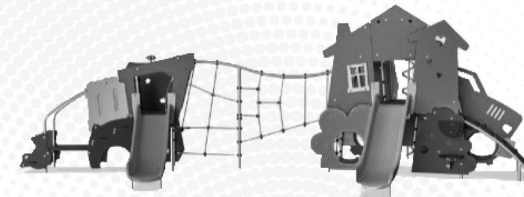

Data version no. 2023-10-05

The CO<sub>2</sub> calculation and data are in compliance with the principles of a carbon footprint impact according to the GHG protocol (Greenhouse Gas Protocol), Scope 3, cradle to gate related to all individual components in the product category: "Themed play systems" represented by item no.: MSC641100-3717P.

(Scope 3 emissions include emission sources in the upstream and downstream value chain).

**Date: 30. October 2023 | Valid until: 30. October 2025**

Verified by:

Julie Marie Vejsgaard Larsen, LCA & EPD Consultant

Verification based on report: Validation of CO<sub>2</sub> calculation of 9 categories of Kompan product line, version 1.0, prepared by: Bureau Veritas HSE, Denmark: Julie M. V. Larsen.

**Publication date: 30. October 2023**

By Bureau Veritas HSE  
 www.bureauveritas.dk  
 +45 7731 1000





# Little Mermaid & Tinderbox with Castle

MSC6432

\* Max fall height | \*\* Total height | \*\*\* Safety surfacing area

\* Max fall height | \*\* Total height

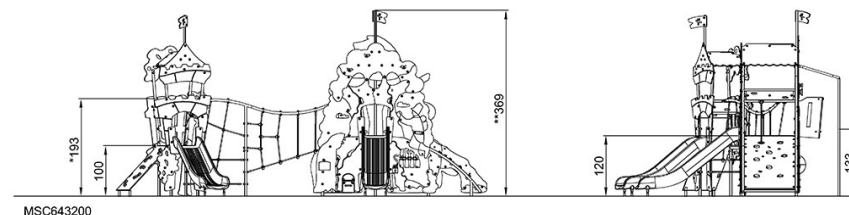
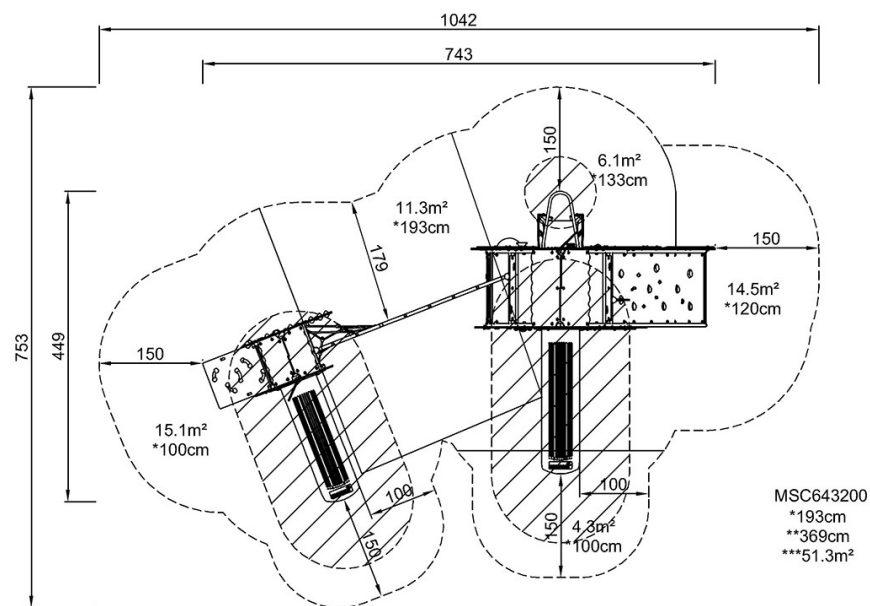

[Click to see TOP VIEW](#)

[Click to see SIDE VIEW](#)