

# Embankment Slide, wide

PCM110221

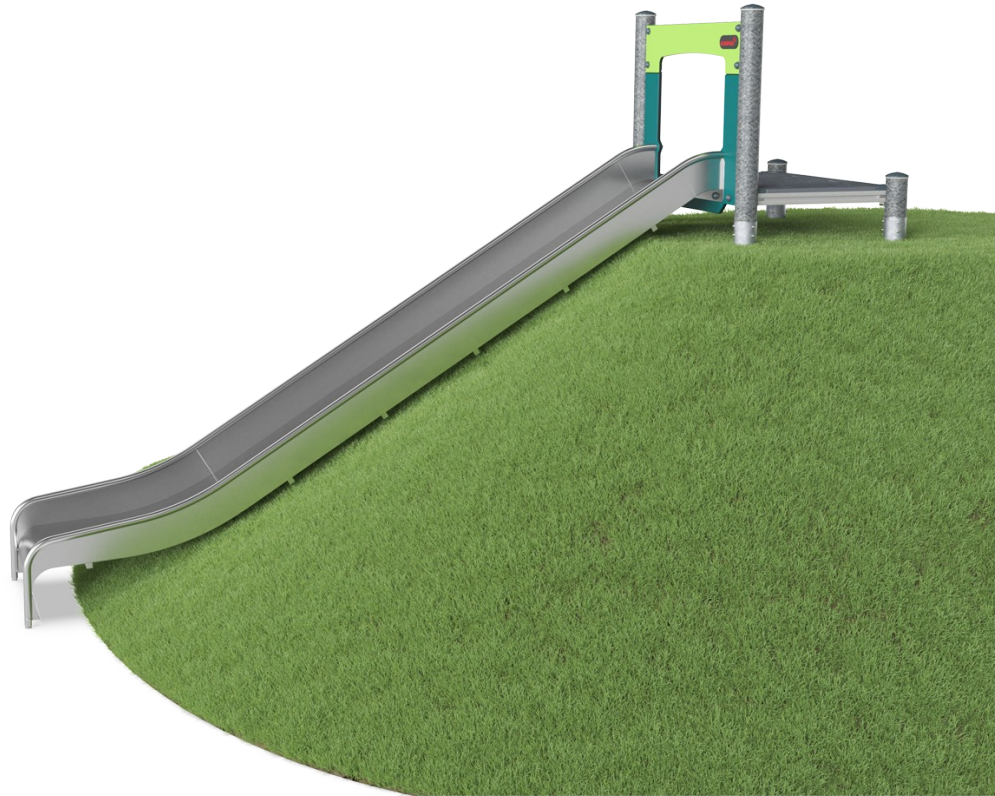

Item no. PCM110221-0951	
<b>General Product Information</b>	
Dimensions LxWxH	403x121x110 cm
Age group	3+
Play capacity (users)	3
Colour options	



Sliding is a favourite playground activity that attracts children to being active and playful in a thrilling way. An embankment slide is especially exciting and accessible with the entry at the ground level, and a fast sliding path that follows the form of the land. The wide slide increases capacity and social play. When children slide they train their core muscles, sitting upright

while sliding down. This stimulates stability, important for avoiding back and neck pains – a growing problem in children due to sedentary lifestyles. Sliding additionally trains the child's sense of balance and space awareness understanding. These skills are important in navigating the world safely and are also the basis of all motor skills. Developing these skills

supports physical confidence in children. Children are especially keen to try the embankment slide over and over again therefore increasing their physical activity.

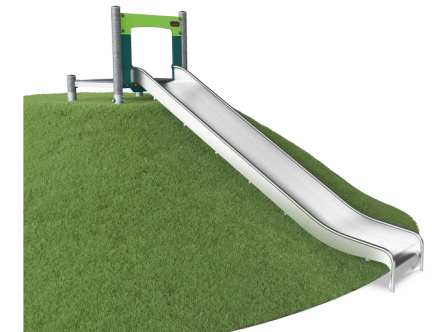

*Data is subject to change without prior notice.*

# Embankment Slide, wide

PCM110221



## Wide slide

**Physical:** develops spatial awareness, sense of balance and trains core muscles when sitting upright going down. **Social-Emotional:** invites socialising, supports parent-child and peer-to-peer play. **Cognitive:** young children develop their understanding of space, speed and distances when sliding down.

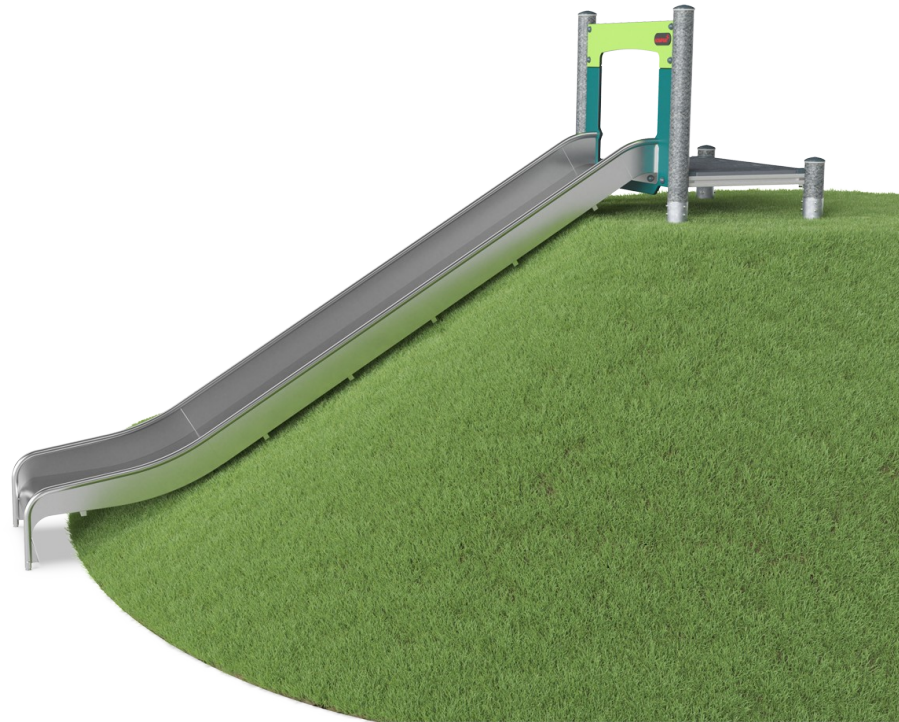

# Embankment Slide, wide

PCM110221



The slides can be chosen in different materials and colours: Straight or curved one-piece molded PE slides in yellow or grey color. Combined EcoCore™ sides and stainless-steel. Full stainless steel in one-piece design for more vandalism proof solutions.

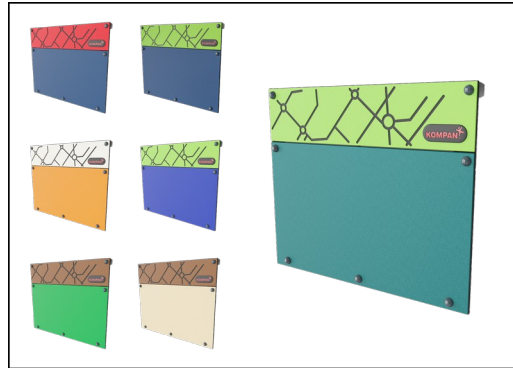

Panels of 19mm EcoCore™. EcoCore™ is a highly durable, eco-friendly material, which is not only recyclable after use but also consists of a core produced from 100% recycled material.



Main posts with hot dip galvanized steel footing are available in different materials: Pressure impregnated pine wood posts. Pre-galvanized inside and outside with powder coated top finish steel posts. Lead free aluminum with color anodized top finish. Greenline TexMade posts of 95% post-consumer recycled PE and textile waste.

Item no. PCM110221-0951	
Installation Information	
Max. fall height	100 cm
Safety surfacing area	23.7 m <sup>2</sup>
Total installation time	6.2
Excavation volume	0.15 m <sup>3</sup>
Concrete volume	0.00 m <sup>3</sup>
Footing depth (standard)	85 cm
Shipment weight	223 kg
Anchoring options	In-ground <input checked="" type="checkbox"/> Surface <input checked="" type="checkbox"/>
Warranty Information	
EcoCore HDPE	Lifetime
PE Slide	10 years
Post	10 years
PP Decks	10 years
Spare Parts Guarantee	10 years

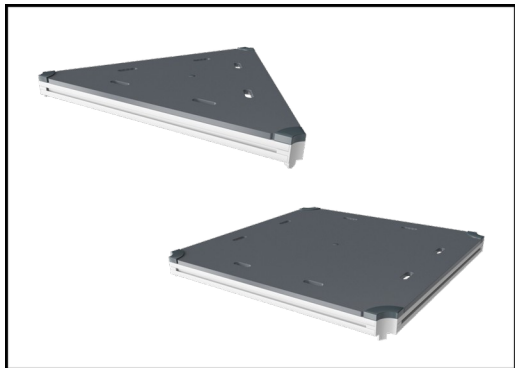

All decks are supported by unique designed low-carbon aluminum profiles with multiple attachment options. The grey colored molded decks are made of 75% post-consumer waste PP material with a non-skid pattern and texture surface.



KOMPAN GreenLine versions are designed with ultimate environmentally friendly materials with lowest possible CO<sub>2</sub>e emission factor. TexMade post, EcoCore™ panels of 95% post-consumer recycled waste and molded PP decks.





# Sustainability Data

PCM110221



Cradle to Gate A1-A3	Total CO <sub>2</sub> emission	CO <sub>2</sub> e/kg	Recycled materials
	kg CO <sub>2</sub> e	kg CO <sub>2</sub> e/kg	%
<b>PCM110221-0951</b>	388.70	2.62	66.08
<b>PCM110221-0902</b>	408.37	2.91	61.77

The overall framework applied for these factors is the Environmental Product Declaration (EPD), which quantifies "environmental information on the life cycle of a product and enable comparisons between products fulfilling the same function" (ISO, 2006). This follows the structure and applies a Life-Cycle Assessment approach to the entire Product stage from raw material through manufacturing (A1-A3))

**Kompan A/S**  
 C.F. Tietgens Boulevard 32C  
 DK-5220 Odense SØ  
 Denmark



## Verification of CO<sub>2</sub> calculation of: Play systems



Data version no. 2023-10-05

The CO<sub>2</sub> calculation and data are in compliance with the principles of a carbon footprint impact according to the GHG protocol (Greenhouse Gas Protocol), Scope 3, cradle to gate related to all individual components in the product category: "Play systems" represented by item no.: PCM200321-0950.

(Scope 3 emissions include emission sources in the upstream and downstream value chain).

**Date: 30. October 2023 | Valid until: 30. October 2025**

Verified by:

Julie Marie Vejsgaard Larsen, LCA & EPD Consultant

Verification based on report: Validation of CO<sub>2</sub> calculation of 9 categories of Kompan product line, version 1.0, prepared by: Bureau Veritas HSE, Denmark: Julie M. V. Larsen.

**Publication date: 30. October 2023**

By Bureau Veritas HSE  
 www.bureauveritas.dk  
 +45 7731 1000



# Embankment Slide, wide

PCM110221

\* Max fall height | \*\* Total height | \*\*\* Safety surfacing area

\* Max fall height | \*\* Total height

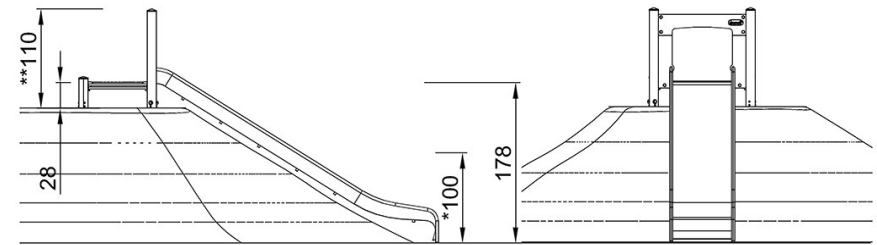
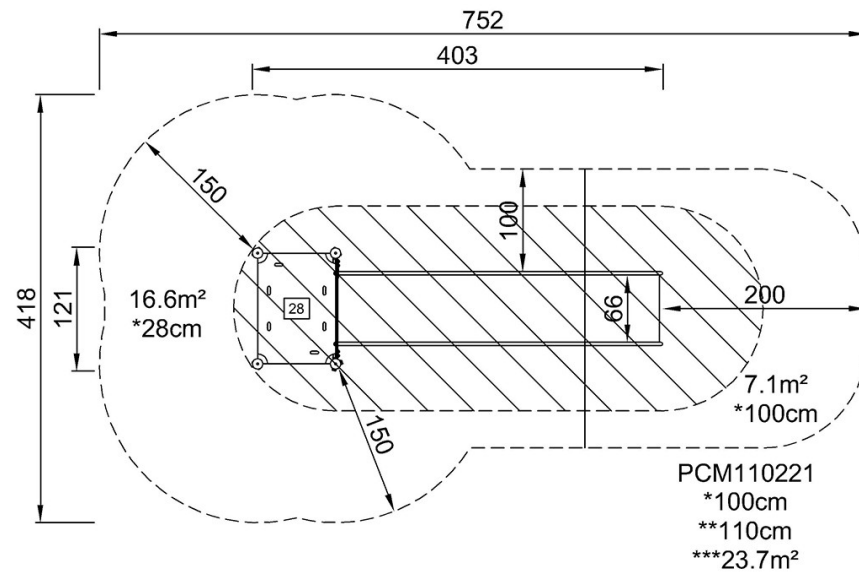

PCM110221

[Click to see TOP VIEW](#)

[Click to see SIDE VIEW](#)