

# Chicken Farm & Horse Carriage

MSC5426

**KOMPANI**  
Let's play

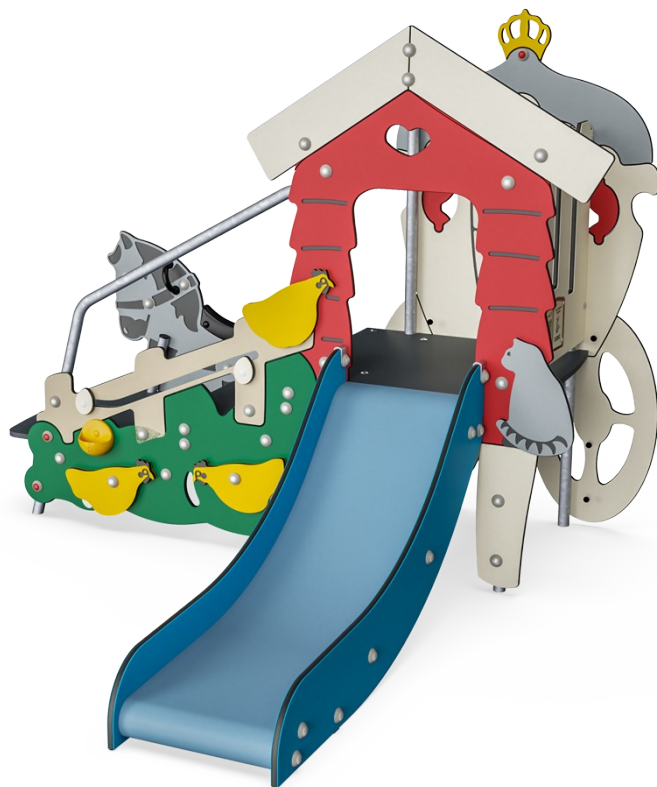

The Chicken Farm & Horse Carriage encourage toddlers to move their bodies and explore. The thrill of crawling up and sliding down is fun and it also trains the toddlers' cross-coordination and balance skills, fundamental to moving confidently in the world. The multitude of moveable sand scoops, eggs and hens that can tilt and reveal eggs, make

for great cognitive-creative play. Toddlers' logical thinking skills and language skills are intensely motivated with these tactile, themed elements. The Carriage side with horse is a fantastic meeting point. It adds to dramatic play and play stories. Taking turns sitting on the horse trains important social-emotional skills, fundamental in friendship building. The QR-

code additionally opens to a world of play stories and educational games around the stories of Hans Christian Andersen.

Item no. MSC542601-3417P	
<b>General Product Information</b>	
Dimensions LxWxH	209x216x166 cm
Age group	1+
Play capacity (users)	8
Colour options	

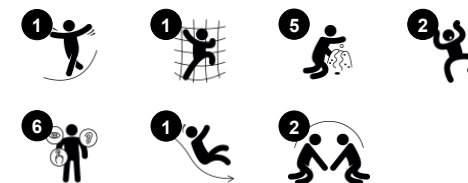

Data is subject to change without prior notice.

# Chicken Farm & Horse Carriage

MSC5426



## Theme

**Cognitive:** suggests a theme and supports dramatic play, which stimulates language and communication skills.

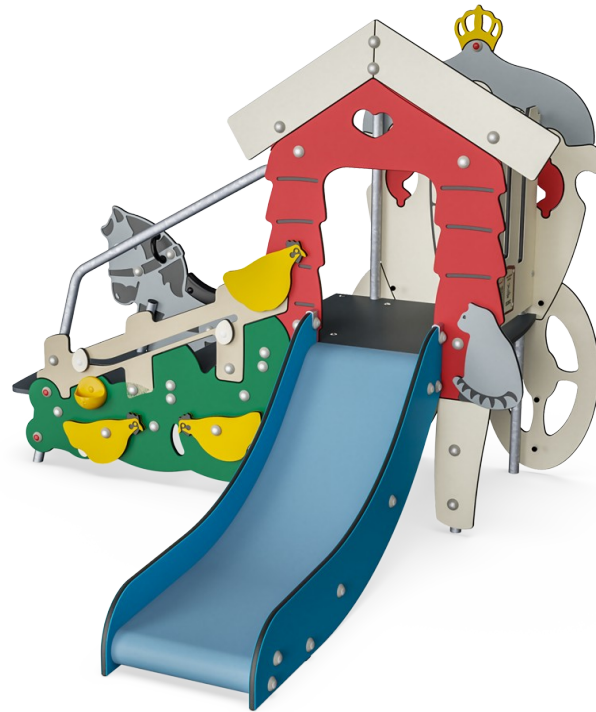

## Slide

**Physical:** sliding develops spatial awareness and a sense of balance. Furthermore, the core muscles are trained when sitting upright going down. **Social-Emotional:** empathy stimulated by turn-taking. **Cognitive:** young children develop their understanding of space, speed and distances when sliding down quickly.

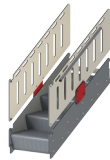

## Accessible stairway

**Physical:** climbing the accessible stairway is for all and supports cross coordination as well as arm and leg muscles. For young children, walking stairs and alternating feet is developed. **Social-Emotional:** room for active breaks and adult helpers. An inclusive space.



## Egg-laying hens

**Social-Emotional:** parallel play: two of same activity. **Cognitive:** hand-eye coordination. cause and effect understanding and language skills are trained when tilting the hen and finding the egg.



## Play sphere

**Social-Emotional:** can be played from both sides, encouraging cooperation. **Cognitive:** cause and effect understanding. **Creative:** leave a mark and place the spheres at different positions.

# Chicken Farm & Horse Carriage

MSC5426



Panels of 19mm EcoCore™. EcoCore™ is a highly durable, eco friendly material, which is not only recyclable after use, but also consists of material produced from +95% recycled post consumer material from food packing waste.



All floors are made of High-Pressure Laminate HPL with a thickness 17.8mm and non skid surface texture according to EN 438-6. KOMPAN HPL has high wearing strength to ensure long lifetime in all climates.



The slide is made of vacuum moulded PE. PE has high impact resistance across a wide temperature span which ensures vandal resistance in all locations.



Handholds are made of injection moulded high quality nylon (PA6). PA6 has good wearing and impact strength.

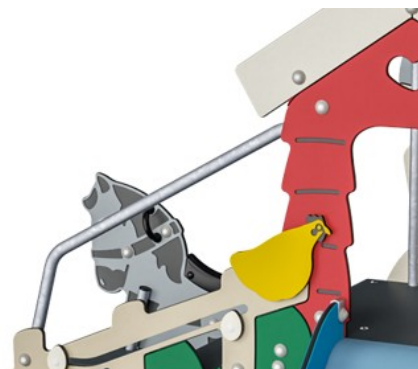

The steel surfaces are hot dip galvanised inside and outside with lead free zinc. The galvanisation has excellent corrosion resistance in outside environments and requires low maintenance.



Saddle is made of PUR. It retains its properties in the temperature range of -30°C to 60°C. Material is UV stabilised.

Item no. MSC542601-3417P

## Installation Information

Max. fall height	100 cm
Safety surfacing area	18.2 m <sup>2</sup>
Total installation time	10.9
Excavation volume	0.28 m <sup>3</sup>
Concrete volume	0.00 m <sup>3</sup>
Footing depth (standard)	60 cm
Shipment weight	201 kg
Anchoring options	In-ground ✓ Surface ✓

## Warranty Information

EcoCore HDPE	Lifetime
Hot dip galvanised steel	Lifetime
HPL decks	15 years
Ropes & nets	10 years
Spare parts guaranteed	10 years



# Sustainability Data

MSC5426



Cradle to Gate A1-A3	Total CO <sub>2</sub> emission	CO <sub>2</sub> e/kg	Recycled materials
	kg CO <sub>2</sub> e	kg CO <sub>2</sub> e/kg	%
<b>MSC542601-3417P</b>	277.41	1.84	57.42

The overall framework applied for these factors is the Environmental Product Declaration (EPD), which quantifies "environmental information on the life cycle of a product and enable comparisons between products fulfilling the same function" (ISO, 2006). This follows the structure and applies a Life-Cycle Assessment approach to the entire Product stage from raw material through manufacturing (A1-A3))

**Kompan A/S**  
C.F. Tietgens Boulevard 32C  
DK-5220 Odense SØ  
Denmark



## Verification of CO<sub>2</sub> calculation of: Themed play systems



Data version no. 2023-10-05

The CO<sub>2</sub> calculation and data are in compliance with the principles of a carbon footprint impact according to the GHG protocol (Greenhouse Gas Protocol), Scope 3, cradle to gate related to all individual components in the product category: "Themed play systems" represented by item no.: MSC641100-3717P.

(Scope 3 emissions include emission sources in the upstream and downstream value chain).

**Date: 30. October 2023 | Valid until: 30. October 2025**

Verified by:

Julie Marie Vejsgaard Larsen, LCA & EPD Consultant

Verification based on report: Validation of CO<sub>2</sub> calculation of 9 categories of Kompan product line, version 1.0, prepared by: Bureau Veritas HSE, Denmark: Julie M. V. Larsen.

**Publication date: 30. October 2023**

By Bureau Veritas HSE  
www.bureauveritas.dk  
+45 7731 1000



# Chicken Farm & Horse Carriage

MSC5426

\* Max fall height | \*\* Total height | \*\*\* Safety surfacing area

\* Max fall height | \*\* Total height

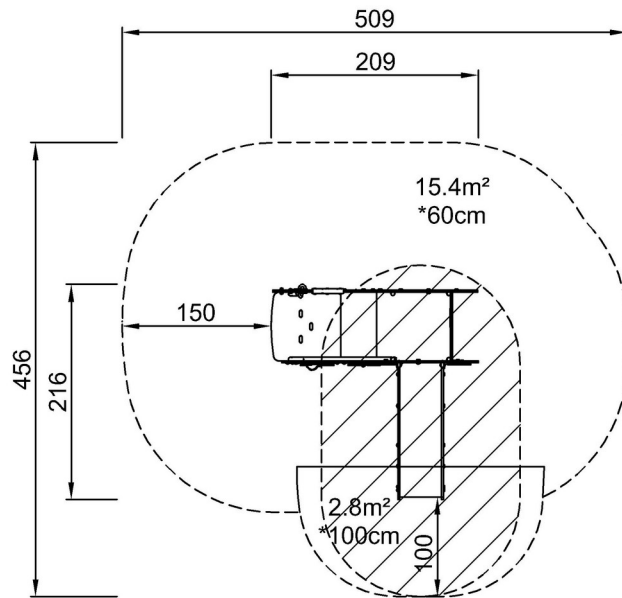

MSC542600  
\*100cm  
\*\*166cm  
\*\*\*18.2m<sup>2</sup>

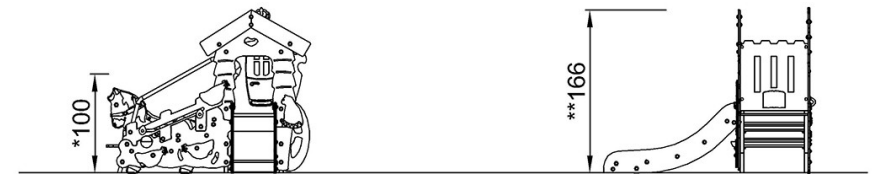

MSC542600

[Click to see TOP VIEW](#)

[Click to see SIDE VIEW](#)