

Play Tower with Ladder

PCM112321

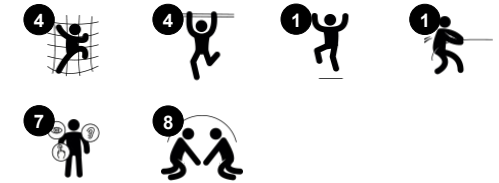

Item no. PCM112321-0902	
General Product Information	
Dimensions LxWxH	490x411x400 cm
Age group	6+
Play capacity (users)	18
Colour options	



WOW – this Play Tower and Overhead Ladder offers an appealing variety of climbing and gliding. The graded challenges and thrilling play activities will make children engaged for a long time. There are variations of climbing in a little space: inclined, through meshes, up and over. This ensures a varied training of the big muscle groups. It additionally trains awareness

and cross-coordination immensely. These are important motor skills that help build the brains ability to read. It also supports the confidence in navigating the body securely, e.g. in traffic. For more thrills, the tower offers a Fireman's pole ride. The Overhead ladder trains children's upper bodies and backs, great training for sedentary children. Under the platform an

inviting space with bench and a time measuring detail activity for meetings, turn-taking and socialising.

Play Tower with Ladder

PCM112321



Fireman's pole

Physical: coordination is supported when going down, as well as arm and core muscles. Landing strengthens bone density, which is built for life in early childhood. **Social-Emotional:** turn-taking and risk-taking.



Climbing net

Physical: children develop cross-body coordination and muscle strength. The asymmetry of the net challenges the children's climbing and crawling through. **Social-Emotional:** the big meshes allow for more children seated together, sharing.



Overhead ladder

Physical: develops children's upper body muscles and arm strength, cross coordination and spatial awareness. This is especially important due to sedentary lifestyles and back-pain in children. **Social-Emotional:** chill and socialize on top of the overhead ladder, training cooperation.



Pipe ladder

Physical: cross coordination and eye-hand coordination are supported when children climb the ladder. The climbing also supports leg and arm muscles. **Social-Emotional:** learning about turn taking and cooperation.



Bench

Social-Emotional: gathering, cooperating or taking a break from play - all train social skills.

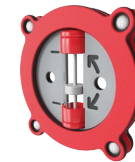

Timer

Social-Emotional: teams can each have a button to measure rounds, wins etc. The buttons support cooperation and teamwork. **Cognitive:** counting and registering support thinking skills such as logical thinking and sequencing. **Creative:** children can leave their mark, placing the timer in different positions.



Rapella

Physical: supports cross coordination, proprioception and sense of space. Leg and core muscles are used intensely. Upper body muscles are developed when children pull themselves upwards in the rope. **Social-Emotional:** turn-taking and self-regulation, both important life skills.

Play Tower with Ladder

PCM112321

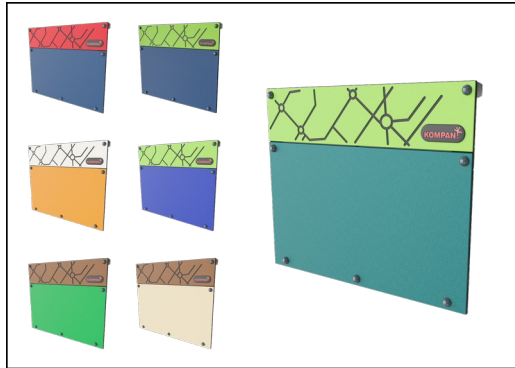

Panels of 19mm EcoCore™. EcoCore™ is a highly durable, eco friendly material, which is not only recyclable after use, but also consists of material produced from +95% recycled post consumer material from food packing waste.



All decks are supported by unique designed low-carbon aluminum profiles with multiple attachment options. The grey colored molded decks are made of 75% post-consumer waste PP material with a non-skid pattern and texture surface.



Main posts with hot dip galvanized steel footing are available in different materials: Pressure impregnated pine wood posts. Pre-galvanized inside and outside with powder coated top finish steel posts. Lead free aluminum with color anodized top finish. Greenline TexMade posts of 95% post-consumer recycled PE and textile waste.

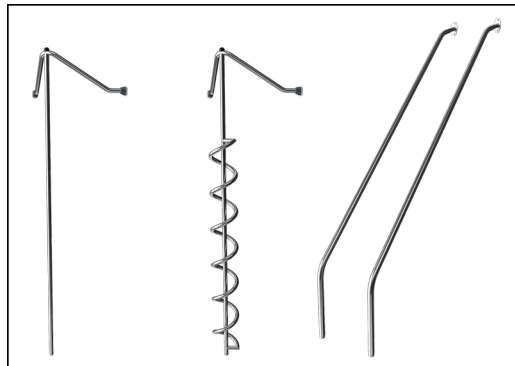

The stainless-steel activities are made of high-quality stainless steel. The steel is cleaned by a total pickling process after manufacturing to ensure a smooth and clean gliding surfaces.

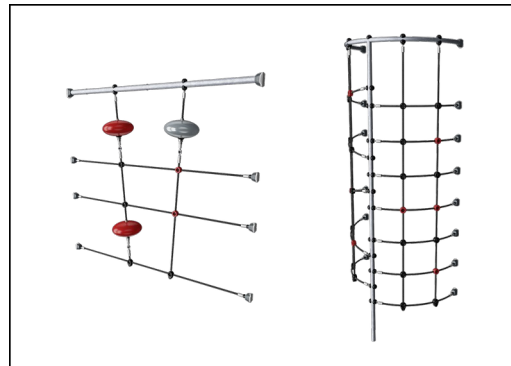

Ropes of UV-stabilized PES rope strands with inner steel cable reinforcement. The polyester yarn is made from +95% post-consumer materials and is inductively melted onto each strand.



KOMPAN GreenLine versions are designed with ultimate environmentally friendly materials with lowest possible CO2e emission factor. TexMade post, EcoCore™ panels of 95% post-consumer recycled waste and molded PP decks.

Item no. PCM112321-0902

Installation Information

Max. fall height	246 cm
Safety surfacing area	47.1 m ²
Total installation time	15.5
Excavation volume	0.47 m ³
Concrete volume	0.11 m ³
Footing depth (standard)	90 cm
Shipment weight	664 kg
Anchoring options	Surface ✓ In-ground ✓

Warranty Information

EcoCore HDPE	Lifetime
Post	10 years
PP Decks	10 years
Ropes & nets	10 years
Spare parts guaranteed	10 years



Sustainability Data

PCM112321



Cradle to Gate A1-A3	Total CO ₂ emission	CO ₂ e/kg	Recycled materials
	kg CO ₂ e	kg CO ₂ e/kg	%
PCM112321-0951	900.63	1.70	71.19
PCM112321-0902	971.82	2.14	63.20

The overall framework applied for these factors is the Environmental Product Declaration (EPD), which quantifies "environmental information on the life cycle of a product and enable comparisons between products fulfilling the same function" (ISO, 2006). This follows the structure and applies a Life-Cycle Assessment approach to the entire Product stage from raw material through manufacturing (A1-A3))

Kompan A/S
C.F. Tietgens Boulevard 32C
DK-5220 Odense SØ
Denmark



Verification of CO₂ calculation of: Play systems



Data version no. 2023-10-05

The CO₂ calculation and data are in compliance with the principles of a carbon footprint impact according to the GHG protocol (Greenhouse Gas Protocol), Scope 3, cradle to gate related to all individual components in the product category: "Play systems" represented by item no.: PCM200321-0950.

(Scope 3 emissions include emission sources in the upstream and downstream value chain).

Date: 30. October 2023 | Valid until: 30. October 2025

Verified by:

Julie Marie Vejsgaard Larsen, LCA & EPD Consultant

Verification based on report: Validation of CO₂ calculation of 9 categories of Kompan product line, version 1.0, prepared by: Bureau Veritas HSE, Denmark: Julie M. V. Larsen.

Publication date: 30. October 2023

By Bureau Veritas HSE
www.bureauveritas.dk
+45 7731 1000



Play Tower with Ladder

PCM112321

* Max fall height | ** Total height | *** Safety surfacing area

* Max fall height | ** Total height

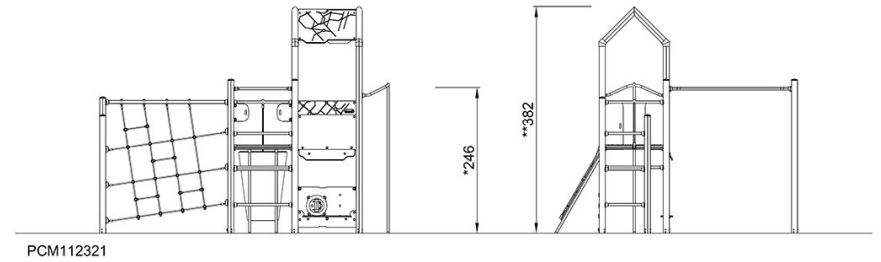
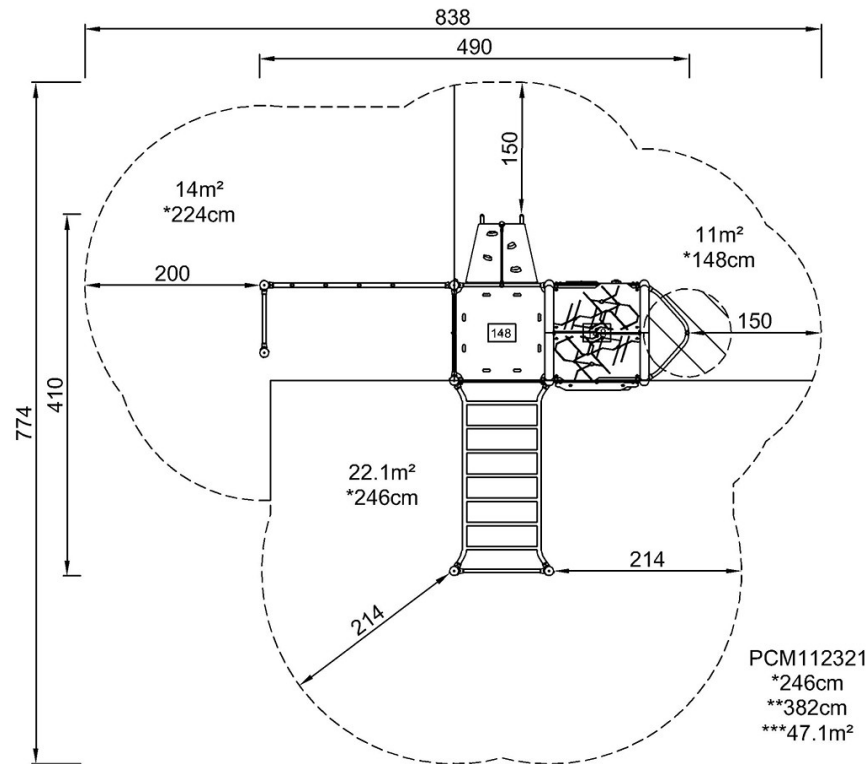

[Click to see TOP VIEW](#)

[Click to see SIDE VIEW](#)