

Seesaw, 4 persons

NRO10601

Item no. NRO10601-0501

General Product Information

| | |
|-----------------------|---|
| Dimensions LxWxH | 415x21x117 cm |
| Age group | 4+ |
| Play capacity (users) | 4 |
| Colour options |   |



The Seesaw 4 is a playground classic. It still attracts players again and again, as it has for generations. The archaic play event is still with us for a reason: the tickling in the stomach when going up high, going down fast is eternally appealing. The Seesaw 4 develops the sense of space and rhythm and leg muscles of children. These are crucial motor

skills that help children navigate the world securely, e.g. in the street when estimating time, movement and objects. The social dimension and degree of trust in your peer that is demanded when seesawing, is great training of social-emotional life skills such as turn-taking and cooperation. With four users, empathy is trained, too. Players will need to

consider others' limits and limitations. Especially in groups of four, the see-sawing is a fantastic social play event.



Seesaw, 4 persons

NRO10601



Rocking movement

Physical: response to movements adds to spatial awareness and sense of balance. These are fundamental motor skills that help the child's ability to sit still on a chair which takes a good sense of balance. **Cognitive:** trains the understanding of cause and effect: when I move my body, the spring responds with movement.



Rocking together

Social-Emotional: the possibility of rocking two together trains cooperation skills. Consideration of others when rocking.

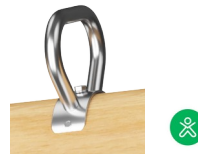

Handhold

Physical: the vertical handgrips ensure a firm grip at different heights, necessary for rocking intensely. This trains hand and arm muscles.

Seesaw, 4 persons

NRO10601

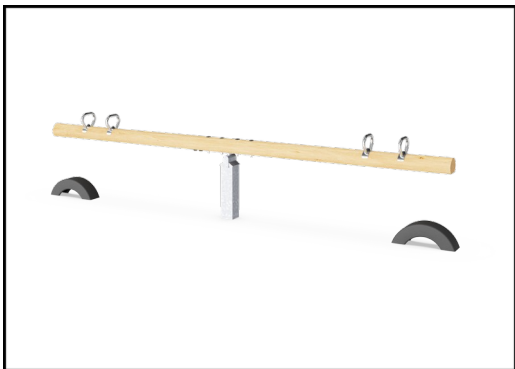

All Organic Robinia products by KOMPAN are made of Robinia wood from sustainable European sources. On request it can be supplied as FSC® Certified (FSC® C004450).

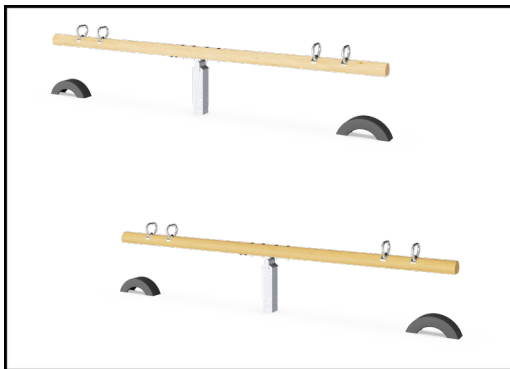

The Robinia wood can be supplied as untreated raw wood or painted with a brown coloured transparent pigment that maintains the golden wood colour of the wood.

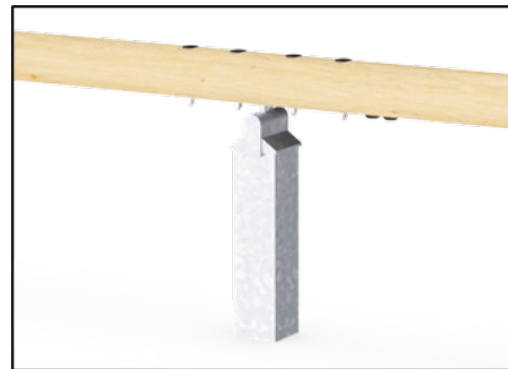

The steel surfaces are hot dip galvanised inside and outside with lead free zinc. The galvanisation has excellent corrosion resistance in outside environments and requires low maintenance.

Item no. NRO10601-0501

Installation Information

| | |
|--------------------------|--------------------------|
| Max. fall height | 117 cm |
| Safety surfacing area | 12.3 m ² |
| Total installation time | 3.0 |
| Excavation volume | 0.59 m ³ |
| Concrete volume | 0.15 m ³ |
| Footing depth (standard) | 70 cm |
| Shipment weight | 131 kg |
| Anchoring options | Surface ✓ In-ground ✓ |

Warranty Information

| | |
|--------------------------|----------|
| Hot dip galvanised steel | Lifetime |
| Robinia wood | 15 years |
| Spare parts guaranteed | 10 years |



Sustainability Data

NRO10601



| Cradle to Gate A1-A3 | Total CO ₂ emission | CO ₂ e/kg | Recycled materials |
|----------------------|--------------------------------|-------------------------|--------------------|
| | kg CO ₂ e | kg CO ₂ e/kg | % |
| NRO10601-0501 | 73.58 | 0.66 | 32.66 |

The overall framework applied for these factors is the Environmental Product Declaration (EPD), which quantifies "environmental information on the life cycle of a product and enable comparisons between products fulfilling the same function" (ISO, 2006). This follows the structure and applies a Life-Cycle Assessment approach to the entire Product stage from raw material through manufacturing (A1-A3))

Kompan A/S
C.F. Tietgens Boulevard 32C
DK-5220 Odense SØ
Denmark



Verification of CO₂ calculation of: Nature play



Data version no. 2023-10-05

The CO₂ calculation and data are in compliance with the principles of a carbon footprint impact according to the GHG protocol (Greenhouse Gas Protocol), Scope 3, cradle to gate related to all individual components in the product category: "Nature play" represented by item no.: NRO409-0621.

(Scope 3 emissions include emission sources in the upstream and downstream value chain).

Date: 30. October 2023 | Valid until: 30. October 2025

Verified by:

Julie Marie Vejsgaard Larsen, LCA & EPD Consultant

Verification based on report: Validation of CO₂ calculation of 9 categories of Kompan product line, version 1.0, prepared by: Bureau Veritas HSE, Denmark: Julie M. V. Larsen.

Publication date: 30. October 2023

By Bureau Veritas HSE
www.bureauveritas.dk
+45 7731 1000



Seesaw, 4 persons

NRO10601

* Max fall height | ** Total height | *** Safety surfacing area

* Max fall height | ** Total height

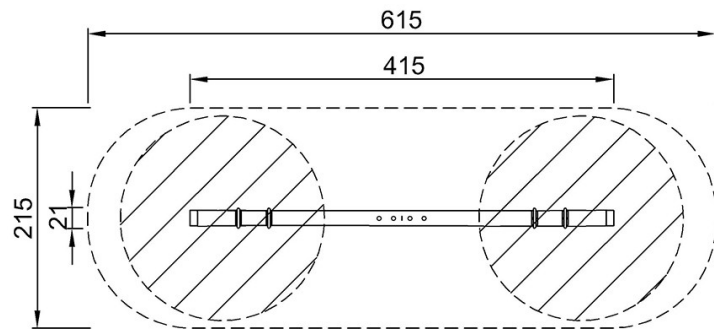

NRO10601
*117cm
**117cm
***12.3m²

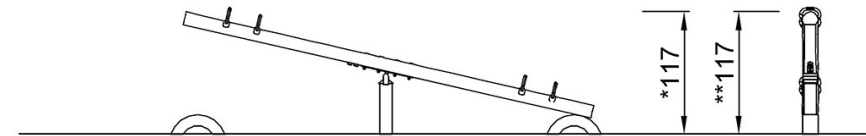

NRO10601

[Click to see TOP VIEW](#)

[Click to see SIDE VIEW](#)