

Gorilla Trail

CRP250601

Item no. CRP250601-0901

General Product Information

Dimensions LxWxH	510x545x257 cm
Age group	6+
Play capacity (users)	18
Colour options	

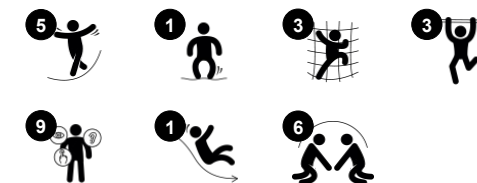

The Gorilla Trail is an exciting and multifunctional play unit, which attracts play instantly. The rich variety of climbing, balancing and sliding activities near ground level invite a range of ages and abilities again and again. Climbing and balancing through the Gorilla Trail is challenging, fun training of the motor skills' ABC: Agility, Balance and Coordination. These

motor skills are fundamental for children's ability to navigate the world confidently, but also their ability to e.g. sitting still. When playing "the ground is made of lava" with friends on the thrilling loops of the Gorilla Trail, children build important social-emotional skills such as turn-taking, empathy and communication skills. These are important in

building social relations and friendships. The slide provides a fun loop back to ground level for a range of ages and abilities.



Data is subject to change without prior notice.

Gorilla Trail

CRP250601



Curved slide

Physical: sliding develops spatial awareness and a sense of balance. Furthermore, the core muscles are trained when sitting upright going down. **Social-Emotional:** empathy stimulated by turn-taking.



Climbing wall

Physical: climbing here develops cross coordination, which supports cross-modal perception, necessary for other skills such as reading.

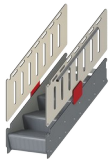

Accessible stairway

Physical: climbing the accessible stairway is for all and supports cross coordination as well as arm and leg muscles. For young children, walking stairs and alternating feet is developed. **Social-Emotional:** room for active breaks and adult helpers. An inclusive space.



Balancing ropes

Physical: holding onto the swaying upper rope when balancing on the swaying lower rope makes excellent training of the sense of balance and trunk muscles. These abilities are fundamental for being able to sit still. **Social-Emotional:** there is room for more than one and cooperating with friends on walking over the swaying ropes is a true cooperation task that requires teamwork and tolerance.

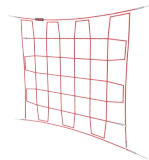

Vertical climbing net

Physical: children develop cross-body coordination when climbing. Arm, leg and core muscles are strengthened. These are important for posture control and also sitting still. **Social-Emotional:** the meshes allow for more children to sit together and talk.

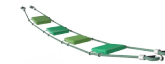

Shaky pods rope

Physical: sense of balance and space, and training of posture. Important for being able to sit still. **Social-Emotional:** cooperation, turn-taking and friendly competition on the plates.



Coconut rope

Physical: balance and coordination is supported when walking the swaying rope. A good sense of balance transfers to other skills such as sitting still on a chair. Bone density is developed when jumping off. **Social-Emotional:** children swaying together on the rope experience their own and others' movements. This spurs cooperation and consideration, e.g. when passing others on the rope.

Gorilla Trail

CRP250601



Ropes of UV-stabilized PES rope strands with inner steel cable reinforcement. The polyester yarn is made from +95% post-consumer materials and is inductively melted onto each strand.



Corocord 'S' clamps are used as universal connections in Corocord products. 8mm stainless steel rods with rounded edges are pressed around the ropes with a special hydraulic press, making them the ideal connector: safe, durable and vandalism-proof, all while allowing the typical movement of rope play structures.

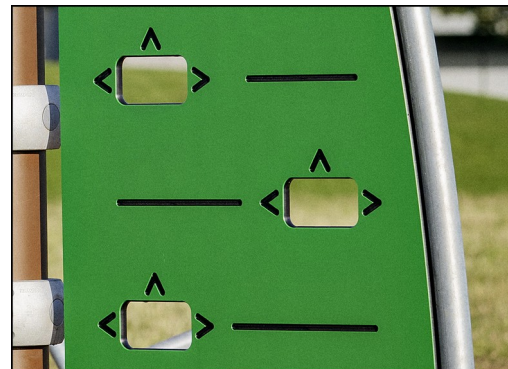

Panels of 19mm EcoCore™. EcoCore™ is a highly durable, eco friendly material, which is not only recyclable after use, but also consists of material produced from +95% recycled post consumer material from food packing waste.

Item no. CRP250601-0901	
Installation Information	
Max. fall height	240 cm
Safety surfacing area	54.2 m ²
Total installation time	22.9
Excavation volume	5.62 m ³
Concrete volume	2.94 m ³
Footing depth (standard)	90 cm
Shipment weight	854 kg
Anchoring options	Surface ✓ In-ground ✓
Warranty Information	
Aluminium clamps	10 years
Hot dip galvanised steel	Lifetime
Painted toplayer	10 years
Ropes & nets	10 years
Spare parts guaranteed	10 years

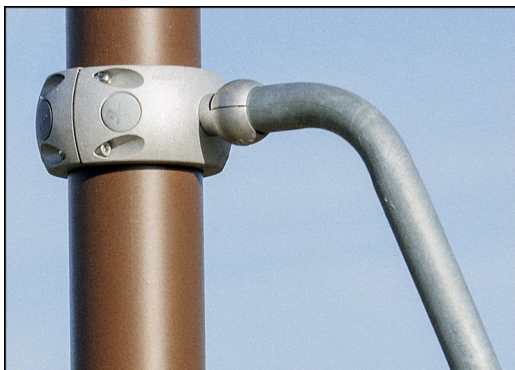

Colored steel components have a base of hot dip galvanization and a powder coated top finish. This provides an ultimate corrosion resistance in all climates around the world. Other steel surfaces are hot dip galvanized inside and outside with lead free zinc.



Corocord smart clamps are carefully designed in every detail to ensure superior flexibility in high quality aluminum material. The smart clamps are attached around the posts with four steel bolts. Not used attachment points are closed with PA caps.

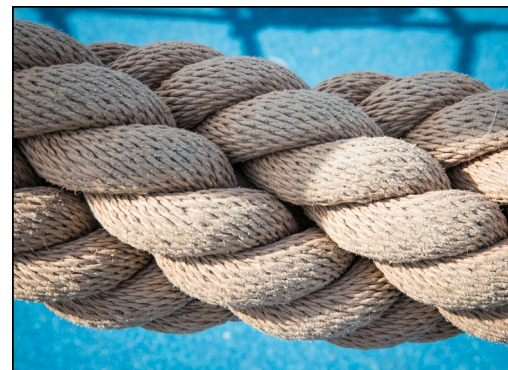

The PP rope in coconut style has a diameter of 150 mm. The internal steel wire core has thimbles at both ends, which serve as attachments for the rope to existing connecting elements.



Sustainability Data

CRP250601



Cradle to Gate A1-A3	Total CO ₂ emission	CO ₂ e/kg	Recycled materials
	kg CO ₂ e	kg CO ₂ e/kg	%
CRP250601-0901	1,761.94	2.99	49.31

The overall framework applied for these factors is the Environmental Product Declaration (EPD), which quantifies "environmental information on the life cycle of a product and enable comparisons between products fulfilling the same function" (ISO, 2006). This follows the structure and applies a Life-Cycle Assessment approach to the entire Product stage from raw material through manufacturing (A1-A3))

Kompan A/S
 C.F. Tietgens Boulevard 32C
 DK-5220 Odense SØ
 Denmark



Verification of CO₂ calculation of: Corocord

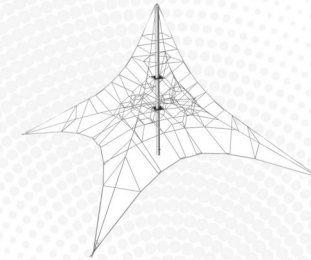

Data version no. 2023-10-05

The CO₂ calculation and data are in compliance with the principles of a carbon footprint impact according to the GHG protocol (Greenhouse Gas Protocol), Scope 3, cradle to gate related to all individual components in the product category: "Corocord" represented by item no.: COR314011-1101.

(Scope 3 emissions include emission sources in the upstream and downstream value chain).

Date: 30. October 2023 | Valid until: 30. October 2025

Verified by:

Julie Marie Vejsgaard Larsen, LCA & EPD Consultant

Verification based on report: Validation of CO₂ calculation of 9 categories of Kompan product line, version 1.0, prepared by: Bureau Veritas HSE, Denmark: Julie M. V. Larsen.

Publication date: 30. October 2023

By Bureau Veritas HSE
 www.bureauveritas.dk
 +45 7731 1000



Gorilla Trail

CRP250601

* Max fall height | ** Total height | *** Safety surfacing area

* Max fall height | ** Total height

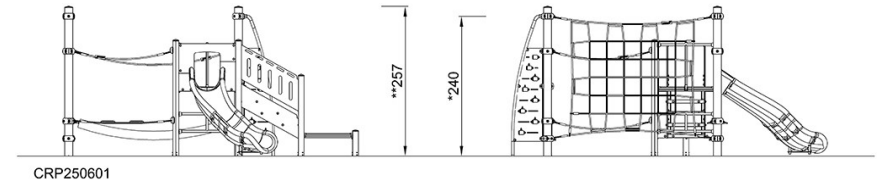
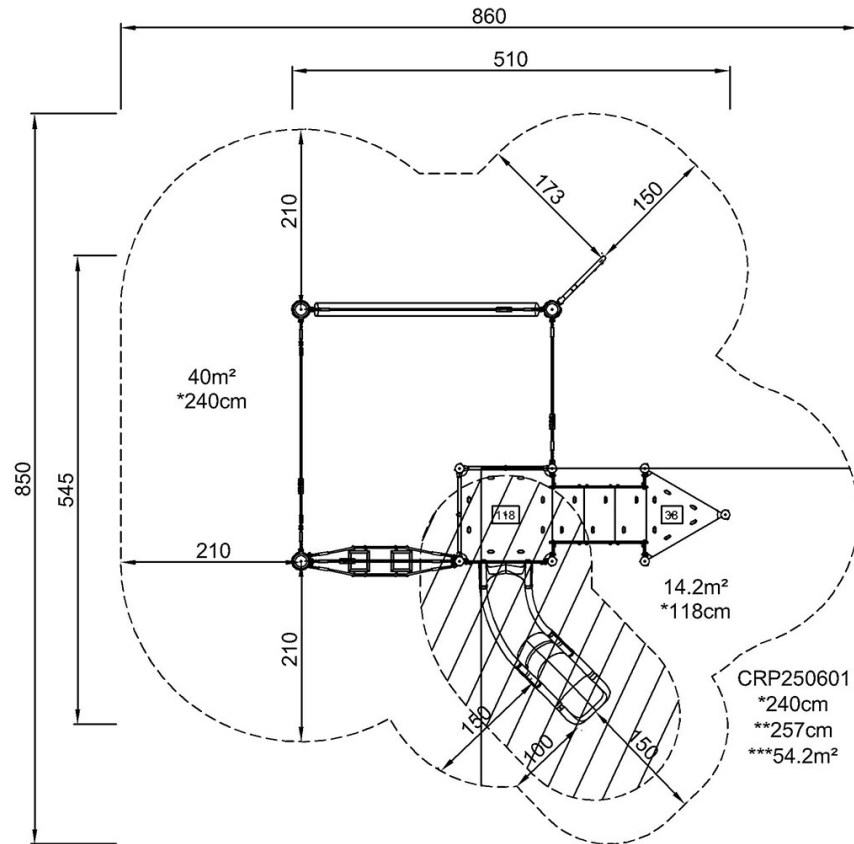

[Click to see TOP VIEW](#)

[Click to see SIDE VIEW](#)