

Magic Bush

MSC5407

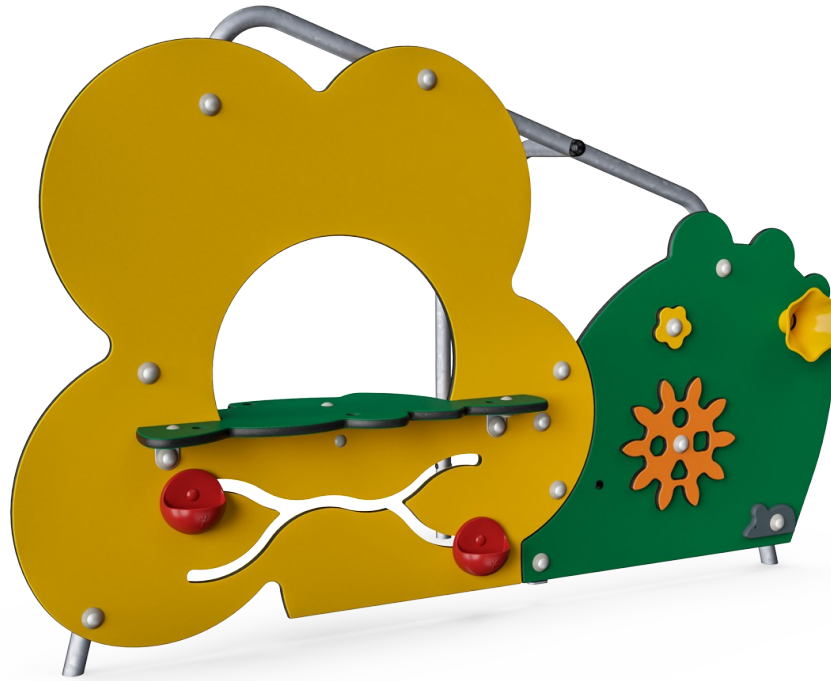

Item no. MSC540700-3417P	
General Product Information	
Dimensions LxWxH	186x87x120 cm
Age group	6m+
Play capacity (users)	4
Colour options	

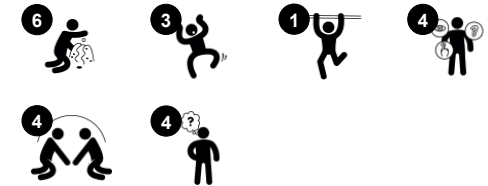

Wow! The Magic Bush will immediately attract toddlers and their parents to play in so many delightful ways. The intentional design leads to longer play-times and enhanced development. Infants play longer when they can manipulate objects and discover the cause and effect actions of their bodies upon the materials. This play structure is loaded with those

opportunities for play. The sand scoops, gears, and pieces of fruit all offer different types of cause and effect movements that children notice and act upon. This helps children to develop logical thinking based in motor planning, key developmental tasks. The counter and window encourage social play and may even inspire dramatic play, as the Magic Bush

could be a florist shop in the minds of the children. Dramatic play spurs language development in active play.



Magic Bush

MSC5407



Sand scoops

Physical: hand eye coordination and push-pull movements. **Social-Emotional:** invites cooperation due to the two-sidedness and provides for parallel play. **Cognitive:** logical thinking: cause and effect understanding when running scoops in grooves or shifting materials from scoop to scoop. **Creative:** shifting scoops, creating new scoop positions.

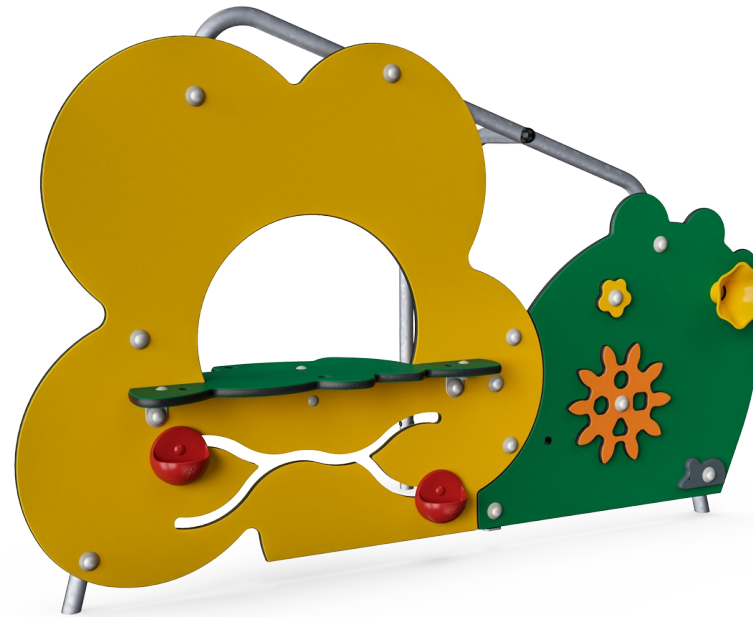

Desk

Social-Emotional: fine meeting place and a space creator. Sharing and cooperation from both sides create a social scenario that supports communication and cooperation.



Megaphone

Social-Emotional: inspires communication and turn-taking skills. **Cognitive:** distortion of sound evokes curiosity and stimulates an understanding of cause and effect.



Gear wheel

Social-Emotional: invites cooperation due to the two-sidedness and provides for parallel play.

Magic Bush

MSC5407

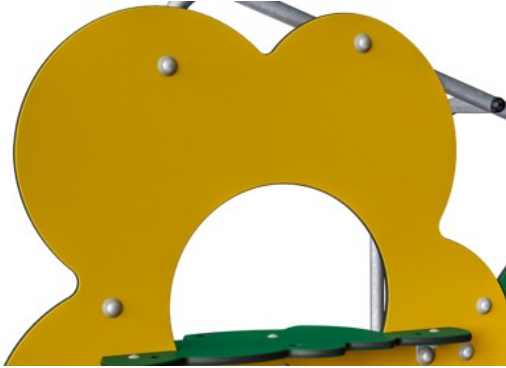

Panels of 19mm EcoCore™. EcoCore™ is a highly durable, eco friendly material, which is not only recyclable after use, but also consists of material produced from +95% recycled post consumer material from food packing waste.



The steel surfaces are hot dip galvanised inside and outside with lead free zinc. The galvanisation has excellent corrosion resistance in outside environments and requires low maintenance.



Play activities like the play sphere are made of injection moulded high quality UV-stabalised nylon (PA6). Nylon has good wearing and impact strength.



KOMPAN GreenLine versions are designed with ultimate environmentally friendly materials with lowest possible CO2e emission factor such as EcoCore™ panels of +95% post consumer recycled ocean waste.

Item no. MSC540700-3417P	
Installation Information	
Max. fall height	0 cm
Safety surfacing area	14.4 m ²
Total installation time	4.8
Excavation volume	0.16 m ³
Concrete volume	0.00 m ³
Footing depth (standard)	60 cm
Shipment weight	52 kg
Anchoring options	In-ground ✓ Surface ✓
Warranty Information	
EcoCore HDPE	Lifetime
Hot dip galvanised steel	Lifetime
Movable parts	2 years
Spare parts guaranteed	10 years



Sustainability Data

MSC5407

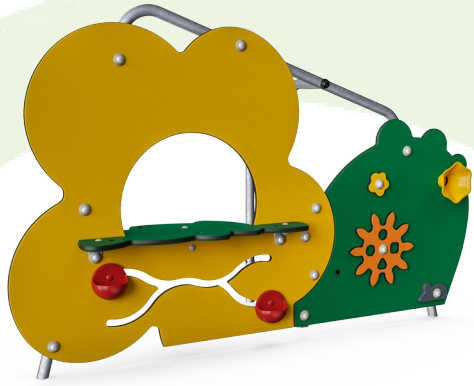

Cradle to Gate A1-A3	Total CO ₂ emission	CO ₂ e/kg	Recycled materials
	kg CO ₂ e	kg CO ₂ e/kg	%
MSC540700-3417P	90.62	1.82	72.54

The overall framework applied for these factors is the Environmental Product Declaration (EPD), which quantifies "environmental information on the life cycle of a product and enable comparisons between products fulfilling the same function" (ISO, 2006). This follows the structure and applies a Life-Cycle Assessment approach to the entire Product stage from raw material through manufacturing (A1-A3))

Kompan A/S
 C.F. Tietgens Boulevard 32C
 DK-5220 Odense SØ
 Denmark



Verification of CO₂ calculation of: Themed play systems



Data version no. 2023-10-05

The CO₂ calculation and data are in compliance with the principles of a carbon footprint impact according to the GHG protocol (Greenhouse Gas Protocol), Scope 3, cradle to gate related to all individual components in the product category: "Themed play systems" represented by item no.: MSC641100-3717P.

(Scope 3 emissions include emission sources in the upstream and downstream value chain).

Date: 30. October 2023 | Valid until: 30. October 2025

Verified by:

Julie Marie Vejsgaard Larsen, LCA & EPD Consultant

Verification based on report: Validation of CO₂ calculation of 9 categories of Kompan product line, version 1.0, prepared by: Bureau Veritas HSE, Denmark: Julie M. V. Larsen.

Publication date: 30. October 2023

By Bureau Veritas HSE
 www.bureauveritas.dk
 +45 7731 1000



Magic Bush

MSC5407

* Max fall height | ** Total height | *** Safety surfacing area

* Max fall height | ** Total height

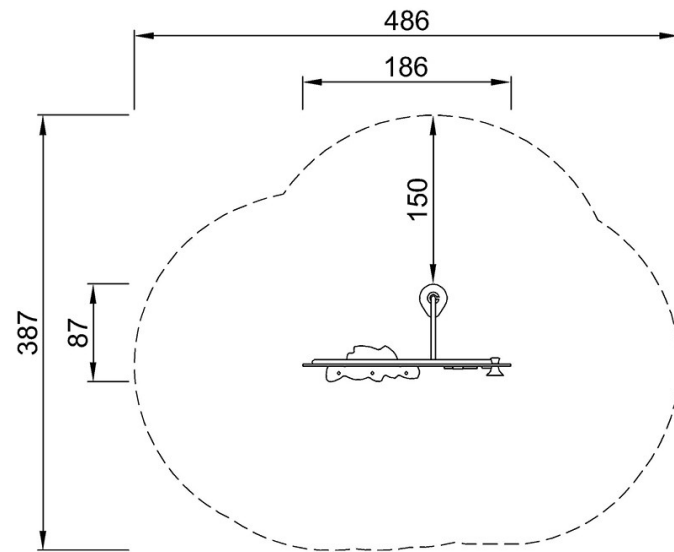

MSC540700P
**120cm
***14.4m²

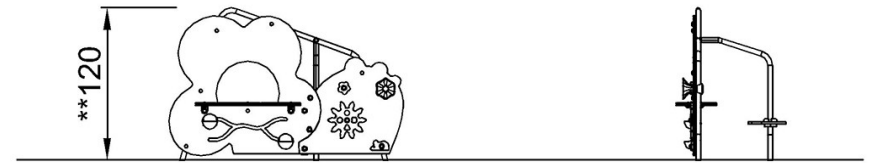

MSC540721

[Click to see TOP VIEW](#)

[Click to see SIDE VIEW](#)